



*ODM-840*

---

**Advanced VSAT Series Remote Router**

*ODMR-840*

---

**Advanced VSAT Series Remote Router  
(Reduced Form Factor)**

*ODMR-840B*

---

**Advanced VSAT Series Remote Router Board Set**

**Installation and Operation Manual**

For Firmware Version 1.6.2.X or higher

**IMPORTANT NOTE:** The information contained in this document supersedes all previously published information regarding this product. Product specifications are subject to change without prior notice.

Copyright © 2015 Comtech EF Data. All rights reserved. Printed in the USA.  
Comtech EF Data, 2114 West 7th Street, Tempe, Arizona 85281 USA, 480.333.2200, FAX: 480.333.2161

# TABLE OF CONTENTS

<b>TABLE OF CONTENTS</b> .....	<b>III</b>
<b>TABLES</b> .....	<b>XII</b>
<b>FIGURES</b> .....	<b>XIII</b>
<b>PREFACE</b> .....	<b>XVII</b>
<b>About this Manual</b> .....	<b>xvii</b>
Related Documents.....	xvii
<b>Conventions and References</b> .....	<b>xvii</b>
Patents and Trademarks .....	xvii
Warnings, Cautions, and Notes.....	xviii
Examples of Multi-Hazard Notices.....	xviii
Recommended Standard Designations.....	xviii
<b>Safety and Compliance</b> .....	<b>xviii</b>
Electrical Safety and Compliance.....	xviii
Electrical Installation.....	xix
Operating Environment .....	xix
European Union Radio Equipment and Telecommunications Terminal Equipment (R&TTE) Directive (1999/5/EC) and EN 301 489-1 .....	xx
European Union Electromagnetic Compatibility (EMC) Directive (2004/108/EC).....	xx
European Union Low Voltage Directive (LVD) (2006/95/EC).....	xx
European Union RoHS Directive (2002/95/EC).....	xxi
European Union Telecommunications Terminal Equipment Directive (91/263/EEC).....	xxi
CE Mark.....	xxi
<b>Product Support</b> .....	<b>xxi</b>
<b>Comtech EF Data Headquarters</b> .....	<b>xxi</b>
<b>Warranty Policy</b> .....	<b>xxii</b>
Limitations of Warranty .....	xxii
Exclusive Remedies .....	xxiii
<b>CHAPTER 1. INTRODUCTION</b> .....	<b>1-1</b>
<b>1.1 Overview</b> .....	<b>1-1</b>
<b>1.2 Functional Description</b> .....	<b>1-3</b>

<b>1.3</b>	<b>Product Features.....</b>	<b>1-5</b>
1.3.1	Physical Description.....	1-5
1.3.1.1	Standard Assemblies (by CEFD P/N) .....	1-5
1.3.1.1.1	ODM-840 Remote Router .....	1-5
1.3.1.1.2	ODMR-840 Reduced Form Factor Remote Router .....	1-5
1.3.1.1.3	ODMR-840B Remote Router Board Set .....	1-5
1.3.1.2	Optional Assemblies (by CEFD P/N) .....	1-6
1.3.1.2.1	ODM-840 Remote Router Options .....	1-6
1.3.1.2.2	Installation Kits .....	1-6
1.3.1.2.2.1	ODM-840 and ODMR-840 Installation Kits .....	1-6
1.3.2	Dimensional Envelopes.....	1-7
1.3.2.1	ODM-840 Dimensional Envelope .....	1-7
1.3.2.2	ODMR-840 Dimensional Envelope.....	1-8
1.3.2.3	ODMR-840B Dimensional Envelopes .....	1-9
1.3.3	Physical Features .....	1-11
1.3.3.1	Connectors Panel .....	1-11
1.3.3.1.1	Connectors Panel Standard Features .....	1-12
1.3.3.1.2	Connectors Panel Optional Features (ODM-840 Only).....	1-13
<b>1.4</b>	<b>Specifications.....</b>	<b>1-14</b>
1.4.1	Product Specifications .....	1-14
1.4.2	BER (Bit Error Rate).....	1-16
1.4.3	Regulatory Compliance.....	1-16
<b>CHAPTER 2.</b>	<b>ODM-840 CONNECTIONS .....</b>	<b>2-1</b>
<b>2.1</b>	<b>Overview – Cabling Connections Types.....</b>	<b>2-1</b>
2.1.1	Coaxial Cable Connections.....	2-2
2.1.1.1	Type ‘BNC’ .....	2-3
2.1.1.2	Type ‘TNC’ .....	2-3
2.1.1.3	Type ‘N’ .....	2-3
2.1.1.4	Type ‘F’ .....	2-3
2.1.1.5	Type ‘SMA’ (Subminiature Version ‘A’).....	2-3
2.1.5	ODMR-840B Header Connections .....	2-5
<b>2.2</b>	<b>ODM-840 Cabling Connections .....</b>	<b>2-7</b>
2.2.1	IF Connectors Group.....	2-9
2.2.1.1	Type ‘N’ IF Connector ‘Rx’ .....	2-9
2.2.1.2	Type ‘N’ IF Connector ‘Tx’ .....	2-9
2.2.1.3	Type ‘SMA’ IF Connector ‘Rx’ (ODMR-840B only).....	2-9
2.2.1.4	Type ‘SMA’ IF Connector ‘Tx’ (ODMR-840B only).....	2-9
2.2.2	Terrestrial Data Connector Group .....	2-10
2.2.2.1	‘ETHERNET T/M’ (Traffic/Management) Connector .....	2-10
2.2.2.2	‘G.703   IN’ / ‘G.703   OUT’ Connectors, BNC (ODM-840 only) .....	2-10
2.2.3	Utility Connector Group .....	2-11
2.2.3.1	‘CONSOLE/REDUNDANCY’ Connector.....	2-11
2.2.3.2	ODM/R-840 ‘CONSOLE/REDUNDANCY’ Connector .....	2-12

2.2.3.3	ODMR-840B Board Set 'CONSOLE/REDUNDANCY' Header .....	2-13
<b>2.3</b>	<b>ODM-840 Fusing, Grounding, and Power Connections.....</b>	<b>2-14</b>
2.3.1	Fusing.....	2-14
2.3.2	Grounding.....	2-14
2.3.3	Power Connections.....	2-15
2.3.3.1	ODM-840 Alternating Current (AC) Power Interface.....	2-15
2.3.3.2	Direct Current (DC) Power Interfaces .....	2-15
2.3.3.2.1	ODM/R-840 Direct Current (DC) Power Interface .....	2-15
2.3.3.2.2	ODMR-840B Board Set Direct Current (DC) Power Interfaces .....	2-16
<b>CHAPTER 3.</b>	<b>INSTALLATION.....</b>	<b>3-1</b>
<b>3.1</b>	<b>Unpack and Inspect the Shipment .....</b>	<b>3-1</b>
<b>3.2</b>	<b>Prepare for ODM-840 Standalone Installation.....</b>	<b>3-1</b>
<b>3.3</b>	<b>ODM-840 Standalone Installation.....</b>	<b>3-2</b>
3.3.1	Overview.....	3-2
3.3.2	Install the ODM-840 KT-0000262 Pole Mounting Kit (with Unit Mounting Kit Unistruts).....	3-5
3.3.3	Install the ODM-840 KT-0000227 Mounting Kit .....	3-8
3.3.4	ODM-840 Cabling.....	3-11
3.3.4.1	ODM-840 Cabling.....	3-12
3.3.4.2	ODMR-840 Cabling.....	3-13
3.3.4.3	ODMR-840B Cabling.....	3-14
3.3.4.4	Field-Fabricated User Cabling .....	3-15
3.3.4.4.1	Fabricate an ODM-840 AC Power Cable .....	3-15
3.3.4.4.2	Fabricate an ODM-840 DC Power Cable .....	3-15
3.3.4.4.3	Fabricate an ODMR-840B DC Power Cable.....	3-16
3.3.4.4.4	Fabricate a Serial Communication Cable .....	3-16
3.3.4.4.4.1	Fabricate an ODM-840 Serial Communication Cable .....	3-16
3.3.4.4.4.2	Fabricate an ODMR-840B Serial Communication Cable .....	3-16
3.3.4.4.5	Fabricate an Ethernet Cable .....	3-17
3.3.4.4.5.1	Fabricate an ODM-840 Ethernet Cable.....	3-17
3.3.4.4.5.2	Fabricate an ODMR-840 Ethernet Cable.....	3-19
<b>CHAPTER 4.</b>	<b>UPDATING FIRMWARE.....</b>	<b>4-1</b>
<b>4.1</b>	<b>Firmware Update Overview .....</b>	<b>4-1</b>
<b>4.2</b>	<b>Getting Started: Prepare for the Firmware Download .....</b>	<b>4-2</b>
<b>4.3</b>	<b>Download and Extract the Firmware Update .....</b>	<b>4-6</b>
<b>4.4</b>	<b>Perform the Ethernet FTP Upload Procedure .....</b>	<b>4-8</b>
<b>CHAPTER 5.</b>	<b>FAST ACTIVATION PROCEDURE.....</b>	<b>5-1</b>

<b>5.1</b>	<b>Overview</b>	<b>5-1</b>
<b>5.2</b>	<b>FAST Activation Using the HTTP Interface</b>	<b>5-2</b>
5.2.1	FAST Configuration	5-2
5.2.2	FAST Upgrade	5-4
<b>CHAPTER 6. ETHERNET-BASED REMOTE PRODUCT MANAGEMENT</b>		<b>6-1</b>
<b>6.1</b>	<b>Introduction</b>	<b>6-1</b>
<b>6.2</b>	<b>Ethernet Management Interface Protocols</b>	<b>6-2</b>
6.2.1	Ethernet Management Interface Access	6-2
6.2.2	SNMP Interface	6-3
6.2.2.1	Management Information Base (MIB) Files	6-3
6.2.2.2	SNMP Community Strings	6-4
6.2.3	ODM-840 HTTP Interface	6-4
6.2.3.1	User Login	6-4
6.2.3.2	HTTP Interface – Operational Features	6-5
6.2.3.2.1	Virtual Front Panel	6-5
6.2.3.2.1.1	Virtual LEDs	6-6
6.2.3.2.2	Navigation	6-7
6.2.3.2.3	Page Sections	6-7
6.2.3.2.4	Action Buttons	6-8
6.2.3.2.5	Drop-down Lists	6-8
6.2.3.2.6	Text or Data Entry	6-8
6.2.3.3	HTTP Interface Menu Tree Diagram	6-9
<b>6.3</b>	<b>HTTP Interface Page Descriptions</b>	<b>6-10</b>
6.3.1	Home Pages	6-10
6.3.1.1	Home   Home Page	6-10
6.3.1.2	Home   Contact	6-11
6.3.2	Admin (Administration) Pages	6-12
6.3.2.1	Admin   Access	6-12
6.3.2.2	Admin   SNMP	6-13
6.3.2.3	Admin   FAST	6-14
6.3.2.4	Admin   Firmware	6-15
6.3.2.5	Admin   Auto Logout	6-16
6.3.2.6	Admin   VMS	6-17
6.3.3	Configuration Pages	6-19
6.3.3.1	Configuration   Interface Pages	6-19
6.3.3.1.1	Configuration   Interface   Mgt/Traffic	6-19
6.3.3.1.2	Configuration   Interface   E1 Pages (ODM-840 ONLY)	6-21
6.3.3.1.2.1	Configuration   Interface   E1   Configuration	6-21
6.3.3.1.2.2	Configuration   Interface   E1   Time Slots	6-23
6.3.3.2	Configuration   WAN pages	6-24
6.3.3.2.1	Configuration   WAN   Demod Pages	6-24
6.3.3.2.1.1	Configuration   WAN   Demod   Config	6-24

6.3.3.2.1.2	Configuration   WAN   Demod   ACM (Adaptive Coding and Modulation) .....	6–29
6.3.3.2.2	Configuration   WAN   Mod (Modulator) Pages .....	6–31
6.3.3.2.2.1	Configuration   WAN   Mod   Config .....	6–31
6.3.3.2.2.2	Configuration   WAN   Mod   ACM .....	6–35
6.3.3.2.2.3	Configuration   WAN   Mod   DPC .....	6–37
6.3.3.2.3	Configuration   WAN   QoS (Quality of Service) .....	6–39
6.3.3.2.3.1	Page Functionality Common for all QoS Control Modes .....	6–40
6.3.3.2.3.2	Page Functionality Specific to Active QoS Mode .....	6–43
6.3.3.2.4	Configuration   WAN   Label .....	6–47
6.3.3.2.5	Configuration   WAN   Compression .....	6–48
6.3.3.2.6	Configuration   WAN   BUC (Block Up Converter) .....	6–49
6.3.3.3.1	Configuration   Network   Routing Pages .....	6–52
6.3.3.3.1.1	Configuration   Network   Routing   Routes .....	6–52
6.3.3.3.1.2	Configuration   Network   Routing   IGMP .....	6–54
6.3.3.3.1.3	Configuration   Network   Routing   DHCP .....	6–56
6.3.3.3.2	Configuration   Network   ARP .....	6–57
6.3.3.3.3	Configuration   Network   Working Mode .....	6–58
6.3.3.3.4	Configuration   Network   DNS .....	6–59
6.3.3.4	Configuration   ECM (Entry Channel Mode) .....	6–60
6.3.3.5	Configuration   dSCPC (Dynamic Single Carrier per Channel) .....	6–63
6.3.4	Status Pages .....	6–65
6.3.4.1	Status   Statistics Pages .....	6–65
6.3.4.1.1	Status   Statistics   Traffic .....	6–65
6.3.4.1.2	Status   Statistics   Network / Router .....	6–67
6.3.4.1.3	Status   Statistics   Compression .....	6–68
6.3.4.1.4	Status   Statistics   QoS .....	6–69
6.3.4.1.4.1	Page Functionality Common for all QoS Control Modes .....	6–70
6.3.4.1.4.2	Page Functionality Specific to Active QoS Control Mode .....	6–71
6.3.4.1.5	Status   Statistics   E1 Pages (ODM-840 only) .....	6–72
6.3.4.1.5.1	Status   Statistics   E1   Transmit .....	6–72
6.3.4.1.5.2	Status   Statistics   E1   Receive .....	6–73
6.3.4.1.6	Status   Statistics   Trending (ODM-840 only) .....	6–75
6.3.4.2	Status   Monitor Pages .....	6–77
6.3.4.2.1	Status   Monitor   Events .....	6–77
6.3.4.2.2	Status   Monitor   Alarms .....	6–78
6.3.5	Utility Pages .....	6–80
6.3.5.1	Utility   Utility .....	6–80
6.3.5.2	Utility   Carrier ID .....	6–83
6.3.5.3	Utility   Reboot .....	6–84
<b>CHAPTER 7.</b>	<b>SERIAL-BASED REMOTE PRODUCT MANAGEMENT .....</b>	<b>7–1</b>
<b>7.1</b>	<b>Overview .....</b>	<b>7–1</b>
<b>7.2</b>	<b>Remote Commands and Queries Overview .....</b>	<b>7–3</b>
7.2.1	Basic Protocol .....	7–3
7.2.2	Packet Structure .....	7–4

7.2.2.1	Start of Packet.....	7-5
7.2.2.2	Target Address .....	7-5
7.2.2.4	Instruction Code.....	7-5
7.2.2.5	Instruction Code Qualifier .....	7-5
7.2.2.5.1	Controller-to-Target Instruction Code Qualifiers .....	7-6
7.2.2.5.2	Target-to-Controller Instruction Code Qualifiers .....	7-6
7.2.2.6	Optional Message Arguments.....	7-8
7.2.2.7	End of Packet .....	7-8
<b>7.3</b>	<b>Remote Commands and Queries .....</b>	<b>7-9</b>
7.3.1	Table Indexes .....	7-9
7.3.2	Transmit (Tx) Parameters Commands and Queries.....	7-12
7.3.3	Receive (Rx) Parameters Commands and Queries .....	7-14
7.3.4	Demodulator Status Commands and Queries .....	7-16
7.3.5	Transmit (Tx) BERT Command or Query .....	7-17
7.3.6	Receive (Rx) BERT Command or Query .....	7-17
7.3.7	BUC (Block Up Converter) Parameters Commands and Queries .....	7-17
7.3.8	LNB (Low-Noise Block Down Converter) Parameters Commands and Queries .....	7-21
7.3.9	Unit Parameters Commands and Queries .....	7-22
7.3.10	Bulk Configuration String Commands.....	7-28
7.3.11	Redundancy Commands and Queries .....	7-29
7.3.12	Vipersat Management System (VMS) Commands and Queries .....	7-30
7.3.13	Entry Channel Mode (ECM) Commands and Queries.....	7-31
7.3.14	Miscellaneous Utility Commands and Queries.....	7-32
<b>APPENDIX A.</b>	<b>REFERENCE DOCUMENTATION .....</b>	<b>A-1</b>
<b>A.1</b>	<b>Overview .....</b>	<b>A-1</b>
<b>A.2</b>	<b>FEC (Forward Error Correction) Options .....</b>	<b>A-2</b>
<b>A.3</b>	<b>ACM/VCM (Adaptive Coding and Modulation / Variable Coding and Modulation) Operation.....</b>	<b>A-3</b>
<b>A.4</b>	<b>ECM (Entry Channel Mode) Operation .....</b>	<b>A-4</b>
<b>A.5</b>	<b>dMesh (VMS Dynamic Mesh) Connectivity.....</b>	<b>A-5</b>
<b>A.6</b>	<b>DPC (VMS Dynamic Power Control) Operation .....</b>	<b>A-6</b>
<b>APPENDIX B.</b>	<b>FEC (FORWARD ERROR CORRECTION) OPTIONS .....</b>	<b>B-1</b>
<b>B.1</b>	<b>FEC Overview .....</b>	<b>B-1</b>
<b>B.2</b>	<b>DVB-S2: LDPC and BCH .....</b>	<b>B-1</b>
B.2.1	Range of Data Rates.....	B-2
B.2.2	BER, QEF, Eb/No, Es/No Spectral Efficiency, and Occupied Bandwidth .....	B-2



<b>B.3</b>	<b>VersaFEC (Short-block LDPC)</b> .....	<b>B-3</b>
B.3.1	Range of Data Rates.....	B-4
<b>B.4</b>	<b>ODM-840 Rx/Tx Error Performance Characteristics</b> .....	<b>B-4</b>
<b>APPENDIX C. DATA COLLECTION</b> .....		<b>C-1</b>
<b>C.1</b>	<b>Data Collection Overview</b> .....	<b>C-1</b>
<b>C.2</b>	<b>Initial Setup of Communications Between the ODM-840 and the User PC</b> .....	<b>C-3</b>
<b>C.3</b>	<b>Collect the Pre-Reboot Diagnostic Information from the ODM-840</b> .....	<b>C-4</b>
<b>C.4</b>	<b>Collect and Report the Post-Reboot Diagnostic Information from the ODM-840</b> .....	<b>C-5</b>
<b>C.5</b>	<b>Serial Adapter Cable Fabrication Specifications Reference</b> .....	<b>C-7</b>
C.5.1	Customer Assistance.....	C-7
C.5.1.1	Product Support.....	C-7
C.5.1.2	Comtech EF Data Headquarters.....	C-7
<b>APPENDIX D. VERSAFEC RETURN LINK ACM (ADAPTIVE CODING AND MODULATION) OPTION</b> .....		<b>D-1</b>
<b>D.1</b>	<b>Functional Overview</b> .....	<b>D-1</b>
D.1.1	Background.....	D-2
<b>D.2</b>	<b>VersaFEC ACM</b> .....	<b>D-3</b>
D.2.1	VersaFEC ACM Latency.....	D-4
<b>D.3</b>	<b>ODM-840 VersaFEC ACM Operation</b> .....	<b>D-5</b>
D.3.1	VersaFEC ACM Operation Using the HTTP Interfaces .....	D-5
D.3.2	Troubleshooting.....	D-8
D.3.3	Monitoring ACM Performance .....	D-8
D.3.4	ModCod Switch Points.....	D-8
<b>D.4</b>	<b>ACM Congestion Control</b> .....	<b>D-9</b>
<b>D.5</b>	<b>Notes and Recommendations</b> .....	<b>D-10</b>
<b>D.6</b>	<b>Summary of Specifications</b> .....	<b>D-11</b>
<b>APPENDIX E. CARRIER ID (DVB-CID METACARRIER®)</b> .....		<b>E-1</b>
<b>E.1</b>	<b>Functional Overview</b> .....	<b>E-1</b>
E.1.1	About MetaCarrier.....	E-1
E.1.2	Functional Description.....	E-2

**E.2 ODM-840 Carrier ID Operation ..... E-3**  
E.2.1 CID Operation – ODM-840 HTTP Interface..... E-3  
E.2.2 CID Operation – Serial Remote Control..... E-6

**APPENDIX F. ECM (ENTRY CHANNEL MODE)..... F-1**

**F.1 Functional Overview ..... F-1**

F.1.1 ECM Terminology ..... F-1  
F.1.2 ECM Overview ..... F-2  
F.1.3 ODM-840 ECM Message Processing..... F-5  
F.1.4 CDD-880 ECM Message Processing ..... F-6

**F.2 ECM Operational Scenarios ..... F-7**

F.2.1 Scenario 1 – VMS Initial Registration Process ..... F-7  
F.2.2 Scenario 2 – Reverted or Auto-Recovered Messages..... F-7  
F.2.2.1 ECM Revert Cycle Timing ..... F-8  
F.2.2.2 ECMv2 Backoff Algorithm ..... F-8

**F.3 ECM Operation ..... F-10**

F.3.1 ECM Operation – ODM-840 Serial Remote Control ..... F-11  
F.3.2 ECM Operation – HTTP Interfaces..... F-12  
F.3.2.1 ODM-840 HTTP Operation – Remote Router Terminals..... F-14  
F.3.2.2 CDD-880 HTTP Operation – Hub Channel Controller (HCC)..... F-17  
F.3.2.2.1 Tap Message ..... F-19  
F.3.2.2.2 HCC Configuration..... F-19  
F.3.2.2.3 Hub Operation..... F-19

**APPENDIX G. HEADER AND PAYLOAD COMPRESSION..... G-1**

**G.1 Functional Overview ..... G-1**

G.1.1 Traffic Optimization..... G-2  
G.1.2 Compression Performance ..... G-2

**G.2 ODM-840 Header and Payload Compression Operation ..... G-4**

G.2.2 Enable or Disable Header and Payload Compression Operation ..... G-6  
G.2.3 Configure Header and Payload Compression Refresh Rates..... G-7  
G.2.4 View Header and Payload Compression Statistics ..... G-8

**APPENDIX H. RETURN GROUP QOS (QUALITY OF SERVICE)..... H-1**

**H.1 Overview ..... H-1**

H.1.1 QoS Terminology ..... H-1  
H.1.2 QoS List of Supported RFCs (Requests for Comment)..... H-3  
H.1.3 Return 2-Level Group QoS..... H-3  
H.1.4 QoS Operation via Remote Product Control ..... H-6

**H.2 QoS Groups ..... H-7**

H.2.1	QoS Group Matching .....	H-8
H.4.1	Maximum Clipping.....	H-22
H.4.2	Minimum Data Rate.....	H-22
<b>H.5</b>	<b>QoS Statistics Reporting .....</b>	<b>H-25</b>
<b>APPENDIX J. ODM-840 RAN/WAN OPTIMIZATION .....</b>		<b>J-1</b>
<b>J.1</b>	<b>Overview .....</b>	<b>J-1</b>
J.1.1	Radio Access Network (RAN) .....	J-1
J.1.2	RAN Inefficiency.....	J-2
<b>J.2</b>	<b>E1 RAN Optimization.....</b>	<b>J-3</b>
J.2.1	Process Overview.....	J-4
J.2.2	WAN Link Dimensioning and Pre-emptive Bandwidth Management .....	J-5
J.2.2.1	Performance Monitoring via the ODM-840 HTTP Interface .....	J-7
J.2.2.1.1	Traffic Throughput (kbps) Graph .....	J-10
J.2.2.1.2	RAN Link Quality Graph .....	J-10
J.2.2.1.3	RANOp Savings Graph.....	J-11
<b>APPENDIX K. DMESH (VMS DYNAMIC MESH) SOLUTIONS.....</b>		<b>K-1</b>
<b>K.1</b>	<b>Overview .....</b>	<b>K-1</b>
<b>K.2</b>	<b>Operational Features .....</b>	<b>K-2</b>
K.2.1	Vipersat Management System .....	K-2
K.2.2	Return Link VersaFEC® ACM (Adaptive Coding and Modulation) .....	K-4
K.2.2.1	VersaFEC® .....	K-4
K.2.2.2	ACM (Adaptive Coding and Modulation) .....	K-4
K.2.2.2.1	ACM and dMesh .....	K-5
K.2.2.2.2	ACM and DPC (Dynamic Power Control) .....	K-5
<b>K.3</b>	<b>Operational Example .....</b>	<b>K-6</b>
K.3.1	Requirements for Bandwidth-on-Demand and dMesh with SHOD (Single Hop on Demand) .....	K-6
K.3.2	dMesh Operation.....	K-6
K.3.2.1	Create a Distribution List.....	K-7
<b>K.4</b>	<b>Compatibility .....</b>	<b>K-11</b>
<b>K.5</b>	<b>Summary .....</b>	<b>K-11</b>
<b>APPENDIX L. DPC (VMS DYNAMIC POWER CONTROL) .....</b>		<b>L-1</b>
<b>L.1</b>	<b>Overview .....</b>	<b>L-1</b>
L.1.1	Background.....	L-2

<b>L.2</b>	<b>Theory of Operation.....</b>	<b>L-2</b>
L.2.1	About DPC.....	L-2
L.2.2	DPC Functionality.....	L-3
L.2.2.1	Entrance Link Cabling.....	L-3
L.2.2.2	Operational Essentials.....	L-4
L.2.3	DPC Operational Considerations .....	L-7
L.2.3.1	Adaptive Control Loop (ACL) Components .....	L-8
L.2.3.1.1	Closed Loop Mechanism .....	L-9
L.2.3.1.2	ACL Timers.....	L-10
L.2.3.2	LQRM Failure and Recovery Steps .....	L-11
L.2.3.3	DPC with ACM .....	L-12
L.2.3.4	Terminal Maximum Power.....	L-13
L.2.3.5	DPC with ACM and Hub Backoff .....	L-14
L.2.3.6	Hub Fade Control .....	L-15
L.2.4	Roaming with DPC .....	L-16
<b>L.3</b>	<b>DPC Operation .....</b>	<b>L-17</b>
L.3.1	DPC Operation Using the HTTP Interfaces.....	L-18
L.3.1.1	Configure DPC .....	L-19
L.3.1.2	Power Reference in DPC Operation .....	L-20
L.3.1.2.1	Set Power Reference .....	L-20
L.3.1.3	DPC – Status Reporting .....	L-24
L.3.1.4	DPC – Operational Changes .....	L-24
<b>L.4</b>	<b>Firmware Update .....</b>	<b>L-25</b>
<b>L.5</b>	<b>Final Considerations.....</b>	<b>L-25</b>

## TABLES

Table 2-1.	ODM-840 Connectors .....	2-8
Table 2-2.	ODM/R-840 ‘CONSOLE/REDUNDANCY’ Connector Pinout.....	2-12
Table 2-3.	ODMR-840B ‘CONSOLE/REDUNDANCY’ Header Pinout .....	2-13
Table 2-4.	AC Power Pin Assignments .....	2-15
Table 2-5.	ODM/R-840 DC Power Pin Assignments.....	2-15
Table 2-6.	ODMR-840B DC Power Pin Assignments .....	2-17
Table B-1.	The VersaFEC ModCod Set.....	B-4
Table D-1.	The VersaFEC ModCod set.....	D-3
Table D-2.	VersaFEC Implementation of ACM – 100 ksymbols/sec Example Case .....	D-4
Table G-1.	Comtech AHA GZip Performance Comparisons .....	G-3
Table G-2.	Comtech AHA GZip Performance Specifications Support .....	G-3
Table G-3.	Compression Performance .....	G-7
Table K-1.	Comtech EF Data Product Compatibility Reference .....	K-11

# FIGURES

Figure 1-1. ODM-840 Remote Routers .....	1-1
Figure 1-2. Advanced VSAT Series Network Topology Example .....	1-2
Figure 1-3. ODM-840 Dimensional Envelope.....	1-7
Figure 1-4. ODMR-840 Dimensional Envelope .....	1-8
Figure 1-5. ODMR-8490B Board Set Dimensional Envelope – Type ‘N’ Connectors .....	1-9
Figure 1-6. ODMR-8490B Board Set Dimensional Envelope – Type ‘SMA’ Connectors .....	1-10
Figure 1-7. Product Connector Interfaces.....	1-11
Figure 2-1. Coaxial Connector Examples.....	2-2
Figure 2-2. D-Subminiature Connector Examples.....	2-4
Figure 2-3. Header Connection Examples.....	2-5
Figure 2-4. ODMR-840B Header Connectors .....	2-6
Figure 2-5. ODM-840 Connectors .....	2-7
Figure 2-6. ODM-840 Chassis Ground Interface .....	2-14
Figure 2-7. ODMR-840B Board Set DC Power Interfaces.....	2-16
Figure 3-1. ODM-840 Temporary Field Installation Example.....	3-2
Figure 3-2. ODM-840 Remote Router – Standalone Installation.....	3-4
Figure 3-3. ODM-840 Pole Mounting Kit (CEFD P/N KT-0000262) .....	3-5
Figure 3-4. ODM-840 Pole and Unit Mounting Kits – Assembly and Spacing.....	3-7
Figure 3-5. ODM-840 Standalone Unit Mounting Kit (CEFD P/N KT-0000262) .....	3-8
Figure 3-6. ODM-840 Unit Mounting – Spring Nut and Screw Installation and Spacing .....	3-10
Figure 3-7. ODM-840 Unit Mounting – Installation onto Unistruts.....	3-10
Figure 3-8. ODM-840 Cabling Connections.....	3-12
Figure 3-9. ODMR-840 Cabling Connections.....	3-13
Figure 3-10. ODMR-840B Cabling Connections .....	3-14
Figure 3-11. AC Power Cord (REF CEFD P/N CA-0000435).....	3-15
Figure 3-12. DC Power Cord (REF CEFD P/N CA-00020696) .....	3-15
Figure 3-13. Serial Communication Cable (REF CEFD P/N CA-0000722) .....	3-16
Figure 3-14. ODM-840 Ethernet User Cable Assembly.....	3-18
Figure 3-15. ODMR-840 Ethernet User Cable Assembly.....	3-20
Figure 5-1. ODM-840 HTTP Interface – ‘ADMIN   FAST’ Page.....	5-2
Figure 6-1. ODM-840 Serial Interface Example .....	6-2
Figure 6-2. ODM-840 Remote Router Virtual Front Panel.....	6-5
Figure 6-3. ODM-840 HTTP Interface – Menu Tree (FW Ver. 1.6.2.X).....	6-9
Figure 6-4. Home   Home Page .....	6-10
Figure 6-5. Home   Contact Page.....	6-11
Figure 6-6. Admin   Access Page.....	6-12
Figure 6-7. Admin   SNMP Page .....	6-13
Figure 6-8. Admin   FAST Page .....	6-14
Figure 6-9. Admin   Firmware Page.....	6-15
Figure 6-10. Admin   Auto Logout Page .....	6-16
Figure 6-11. Admin   VMS Page.....	6-17
Figure 6-12. Configuration   Interface   Mgt/Traffic Page .....	6-19
Figure 6-13. Configuration   Interface   E1   Configuration Page.....	6-21

Figure 6-14. Configuration   Interface   E1   Time Slots Page .....	6-23
Figure 6-15. Configuration   WAN   Demod   Config Page .....	6-24
Figure 6-16. Configuration   WAN   Demod   ACM Page .....	6-29
Figure 6-17. Configuration   WAN   Mod   Config Page .....	6-31
Figure 6-18. Configuration   WAN   Mod   ACM Page.....	6-35
Figure 6-19. Configuration   WAN   Mod   DPC Page.....	6-37
Figure 6-20. Configuration   WAN   QoS Page (QoS Control Mode = Off).....	6-39
Figure 6-21. Configuration   WAN   Label Page .....	6-47
Figure 6-22. Configuration   WAN   Compression Page.....	6-48
Figure 6-23. Configuration   WAN   BUC Page.....	6-49
Figure 6-24. Configuration   WAN   LNB Page .....	6-51
Figure 6-25. Configuration   Network   Routing   Routes Page.....	6-52
Figure 6-26. Configuration   Network   Routing   IGMP Page.....	6-54
Figure 6-27. Configuration   Network   Routing   DHCP Page.....	6-56
Figure 6-28. Configuration   ARP Page .....	6-57
Figure 6-29. Configuration   Network   Working Mode Page.....	6-58
Figure 6-30. Configuration   Network   DNS Page .....	6-59
Figure 6-31. Configuration   ECM Page .....	6-60
Figure 6-32. Configuration   dSCPC Page .....	6-63
Figure 6-33. Status   Statistics   Traffic Page.....	6-65
Figure 6-34. Status   Statistics   Network   Router Page .....	6-67
Figure 6-35. Status   Statistics   Compression Page.....	6-68
Figure 6-36. Status   Statistics   QoS Page .....	6-69
Figure 6-37. Status   Statistics   E1   Transmit Page.....	6-72
Figure 6-38. Status   Statistics   E1   Receive Page.....	6-73
Figure 6-39. Status   Statistics   Trending Page (Select Time Span = 20 minutes).....	6-75
Figure 6-40. Status   Monitor   Events Page .....	6-77
Figure 6-41. Status   Monitor   Alarms Page.....	6-78
Figure 6-42. Utility   Utility Page .....	6-80
Figure 6-43. Utility   Carrier ID Page.....	6-83
Figure 6-44. Utility   Reboot Page .....	6-84
Figure 7-1. ODM-840 Serial Interface Example .....	7-3
Figure A-1. Advanced VSAT Series Hub and Remote Site Products.....	A-1
Figure B-1. The VersaFEC Codes versus Shannon Capacity .....	B-3
Figure B-2. DVB-S2 QPSK Packet Error Rate versus Es/No.....	B-5
Figure B-3. DVB-S2 8PSK Packet Error Rate versus Es/No .....	B-6
Figure B-4. DVB-S2 16APSK Packet Error Rate versus Es/No .....	B-7
Figure B-5. DVB-S2 32APSK Packet Error Rate versus Es/No .....	B-8
Figure B-6. VersaFEC Codec – BPSK, Rate 0.488 .....	B-9
Figure B-7. VersaFEC Codec – QPSK, Rates 0.533, 0.631, 0.706 and 0.803 .....	B-10
Figure B-8. VersaFEC Codec – 8-QAM, Rates 0.642, 0.711, and 0.780 .....	B-11
Figure B-9. VersaFEC Codec – 16-QAM, Rates 0.731, 0.780, 0.829 and 0.853 .....	B-12
Figure D-1. VersaFEC Codes vs. Constrained Capacity.....	D-4
Figure D-2. ODM-840 HTTP Interface and Menu Tree – VersaFEC ACM Operation (FW Ver. 1.6.2.X) ....	D-6
Figure D-3. ODM-840 HTTP Interface – Configuration   WAN   Mod   ACM Page.....	D-7
Figure D-4. ODM-840 – ACM ModCod Switch Points .....	D-8
Figure D-5. ODM-840 – ACM Congestion Control .....	D-9

Figure E-1. ODM-840 HTTP Interface and Menu Tree – Carrier ID Operation (FW Ver. 1.6.2.X) .....	E-4
Figure E-2. Utility   Carrier ID Page.....	E-5
Figure F-1. ECM – Message Processing Diagram .....	F-2
Figure F-2. ECM Message Processing – ODM-840 Remote Router .....	F-5
Figure F-3. ECM Message Processing – CDD-880 Multi Receiver Router .....	F-6
Figure F-4. HTTP Interfaces – Splash Pages and ECM Operation Menu Trees (FW Ver. 1.6.2.X) .....	F-13
Figure F-5. ODM-840 HTTP Interface – Configuration   ECM Page .....	F-14
Figure F-6. CDD-880 HTTP Interface – Configuration   ECM Page.....	F-17
Figure G-1. HTTP Interface Menu Tree – Compression Operations (FW Ver. 1.6.2.X) .....	G-5
Figure G-2. Configuration   Network   Routing   Routes Page .....	G-6
Figure G-3. Configuration   WAN   Compression page .....	G-7
Figure G-4. Configuration   WAN   MOD   ACM Page .....	G-8
Figure G-5. Status   Statistics   Compression Page .....	G-8
Figure H-1. Group QoS Multi-tenant Site Return QoS .....	H-3
Figure H-2. Group QoS for Multi-tenant Site 2-Level Return QoS Configuration .....	H-4
Figure H-3. ODM-840 HTTP Interface and Menu Tree (FW Ver. 1.6.2.X) .....	H-7
Figure H-4. Configuration   WAN   QoS   QoS Page (Control Mode = Off).....	H-8
Figure H-5. Configuration   WAN   QoS Page (Control Mode = DiffServ) .....	H-17
Figure H-6. Highly Degraded Remote Function – ODM-840 and CTOG-250 HTTP Interfaces .....	H-24
Figure H-7. ODM-840 HTTP Interface – Status   Statistics   QoS Page Examples .....	H-25
Figure J-1. 2G / 3G Radio Access Network (RAN).....	J-1
Figure J-2. Typical Abis Map.....	J-2
Figure J-3. RAN Optimization (GSM Abis Interface).....	J-4
Figure J-4. Optimized Abis Traffic <i>without</i> Pre-emptive BW Management.....	J-5
Figure J-5. Optimized Abis Traffic <i>with</i> Pre-emptive BW Management .....	J-6
Figure J-6. ODM-840 HTTP Interface and Menu Tree – Link Performance Monitoring (FW Ver. 1.6.2.X) .....	J-8
Figure J-7. ODM-840 HTTP Interface – Status   Statistics   Trending Page.....	J-9
Figure K-1. Vipersat Management System – Graphical User Interface (GUI) .....	K-2
Figure K-2. VMS-configured Advanced VSAT Network .....	K-3
Figure K-3. CDD-880 HTTP Interface – Configuration   Network   Routing Page.....	K-9
Figure L-1. DPC Power Scale .....	L-4
Figure L-2. ACM – ModCod Switch Points .....	L-6
Figure L-3. Closed Loop Mechanism .....	L-9
Figure L-4. LQRM / Power Management Flow Diagram .....	L-11
Figure L-5. DPC with ACM at Rate Max Power .....	L-12
Figure L-6. Hub Rain Fade .....	L-13
Figure L-7. DPC w/ACM with Hub Backoff .....	L-14
Figure L-8. Roaming DPC.....	L-16
Figure L-9. HTTP Interfaces – Splash Pages and DPC Operation Menu Trees (FW Ver. 1.6.2.X) .....	L-18

BLANK PAGE



# PREFACE

---

## About this Manual

This manual provides installation and operation information for the Comtech EF Data Advanced VSAT Series ODM-840 Remote Router family of products:

- The ODM-840 Remote Router
- The ODMR-840 Reduced Form Factor Remote Router
- The ODMR-840B Remote Router Board Set

This manual collectively refers to all products as the ODM-840.

This is an informational document intended for the persons responsible for the operation and maintenance of the ODM-840.

## Related Documents

- Comtech EF Data CDM-840 Remote Router Installation and Operation Manual (CEFD P/N MN-CDM840)
- Comtech EF Data CDD-880 Multi Receiver Router Installation and Operation Manual (CEFD P/N MN-CDD880)
- Comtech EF Data CTOG-250 Comtech Traffic Optimization Gateway with CDM-800 Gateway Router Installation and Operation Manual (CEFD P/N MN-CTOG250)

---

## Conventions and References

### Patents and Trademarks

See all of Comtech EF Data's Patents and Patents Pending at <http://patents.comtechefdata.com>.

Comtech EF Data acknowledges that all trademarks are the property of the trademark owners.

## Warnings, Cautions, and Notes



A **WARNING** GIVES INFORMATION ABOUT A POSSIBLE HAZARD THAT MAY CAUSE DEATH OR SERIOUS INJURY.



A **CAUTION** gives information about a possible hazard that MAY CAUSE INJURY or PROPERTY DAMAGE.



A **NOTE** gives important information about a task or the equipment.



A **REFERENCE** directs you to additional information about a task or the equipment.

## Examples of Multi-Hazard Notices

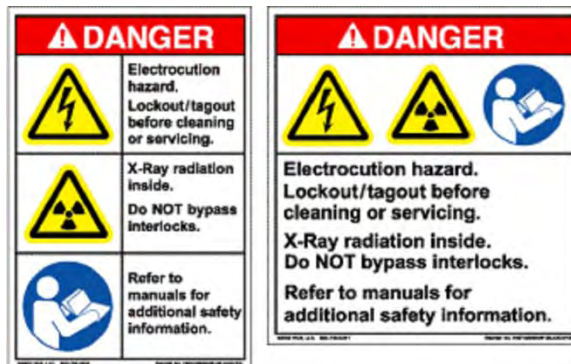

## Recommended Standard Designations

The new designation of the Electronic Industries Association (EIA) supersedes Recommended Standard (RS) designations. References to the old RS designations may be shown when depicting actual text (e.g., RS-232) as displayed on the unit's HTTP (Web Server) Interface pages or the chassis connectors panels. All other references in the manual specify the EIA designations.



**CAUTION – YOU SHOULD CAREFULLY REVIEW THE FOLLOWING INFORMATION.**

---

## Safety and Compliance

### Electrical Safety and Compliance

The unit complies with the **EN 60950 Safety of Information Technology Equipment (Including Electrical Business Machines)** safety standard.



**CAUTION – IF THE UNIT IS OPERATED IN A VEHICLE OR MOVABLE INSTALLATION, MAKE SURE THE UNIT IS STABLE. OTHERWISE, EN 60950 SAFETY IS NOT GUARANTEED.**

## Electrical Installation



**CAUTION – CONNECT THE UNIT TO A POWER SYSTEM THAT HAS SEPARATE GROUND, LINE AND NEUTRAL CONDUCTORS. DO NOT CONNECT THE UNIT WITHOUT A DIRECT CONNECTION TO GROUND.**

## Operating Environment



**CAUTION – DO NOT OPERATE THE UNIT IN ANY OF THESE EXTREME OPERATING CONDITIONS:**

- **AMBIENT OPERATING TEMPERATURES:**

**FOR THE ODM-840 AND ODMR-840, THE TEMPERATURES SHOULD BE NO LESS THAN 0° C (32° F) AND NO MORE THAN 50° C (122° F).**

**OBSERVE THE FOLLOWING LIMITS DURING NORMAL OPERATION, WHEN THE ODM/R-840 IS EQUIPPED WITH THE EXTENDED TEMPERATURE HARDWARE OPTION:**

- **FOR THE ODM-840, THE TEMPERATURE SHOULD BE NO LESS THAN -40° C (-40° F) AND NO MORE THAN 55° C (131° F).**
- **FOR THE ODMR-840, THE TEMPERATURE SHOULD BE NO LESS THAN -20° C (-4° F) AND NO MORE THAN 55° C (131° F).**

**FOR THE ODMR-840B BOARD SET, THE AMBIENT ENCLOSURE TEMPERATURE SHOULD BE, AT MINIMUM, NO LESS THAN -20° C (-4° F); AT MAXIMUM, NO MORE THAN 60° C (140° F). IT IS CRITICAL THAT ADEQUATE HEATING AND COOLING IS PROVIDED WITHIN THE CUSTOMER ENCLOSURE TO ENSURE THAT AMBIENT TEMPERATURES DO NOT EXCEED THESE LIMITS. CONTACT COMTECH EF DATA PRODUCT SUPPORT FOR FURTHER INFORMATION.**

- **PRECIPITATION, CONDENSATION, OR HUMID ATMOSPHERES OF MORE THAN 95% RELATIVE HUMIDITY.**
- **UNPRESSURIZED ALTITUDES OF MORE THAN 2000 METRES (6561.7 FEET).**
- **EXCESSIVE DUST.**
- **FLAMMABLE GASES.**
- **CORROSIVE OR EXPLOSIVE ATMOSPHERES.**

## European Union Radio Equipment and Telecommunications Terminal Equipment (R&TTE) Directive (1999/5/EC) and EN 301 489-1

Independent testing verifies that the unit complies with the European Union R&TTE Directive, its reference to EN 301 489-1 (*Electromagnetic compatibility and Radio spectrum Matters [ERM]; ElectroMagnetic Compatibility [EMC] standard for radio equipment and services, Part 1: Common technical requirements*), and the Declarations of Conformity for the applicable directives, standards, and practices that follow:

---

### European Union Electromagnetic Compatibility (EMC) Directive (2004/108/EC)

- **Emissions: EN 55022 Class B** – Limits and Methods of Measurement of Radio Interference Characteristics of Information Technology Equipment.
- **Immunity: EN 55024** – Information Technology Equipment: Immunity Characteristics, Limits, and Methods of Measurement.
- **EN 61000-3-2** – Harmonic Currents Emission
- **EN 61000-3-3** – Voltage Fluctuations and Flicker.
- **Federal Communications Commission Federal Code of Regulation FCC Part 15, Subpart B.**



**CAUTION – TO ENSURE THAT THE UNIT COMPLIES WITH THESE STANDARDS, OBEY THESE INSTRUCTIONS:**

- Use coaxial cable that is of good quality for connections to the L-Band Type 'N' Rx (receive) female connector.
- Use Type 'D' connectors that have back-shells with continuous metallic shielding.





Type 'D' cabling must have a continuous outer shield (either foil or braid, or both). The shield must be bonded to the back-shell.

- Operate the unit with its cover on at all times.

---

### European Union Low Voltage Directive (LVD) (2006/95/EC)

Symbol	Description
<HAR>	Type of power cord required for use in the European Community.
	CAUTION: <b>Double-pole/Neutral Fusing</b> ACHTUNG: <b>Zweipolige bzw. Neutraleiter-Sicherung</b>

International Symbols			
Symbol	Definition	Symbol	Definition
	Alternating Current		Protective Earth
	Fuse		Chassis Ground



For additional symbols, see the Warnings, Cautions and Notes listed earlier in this Preface.

---

## European Union RoHS Directive (2002/95/EC)

This unit satisfies (with exemptions) the requirements specified in the European Union Directive on the Restriction of Hazardous Substances in Electrical and Electronic Equipment (EU RoHS, Directive 2002/95/EC).

---

## European Union Telecommunications Terminal Equipment Directive (91/263/EEC)

In accordance with the European Union Telecommunications Terminal Equipment Directive 91/263/EEC, the unit should not be directly connected to the Public Telecommunications Network.

---

## CE Mark

Comtech EF Data declares that the unit meets the necessary requirements for the CE Mark.

---

## Product Support

For all product support, please call:

+1.240.243.1880

+1.866.472.3963 (toll free USA)

---

## Comtech EF Data Headquarters

<http://www.comtechefdata.com>

Comtech EF Data Corp.

2114 West 7th Street

Tempe, Arizona USA 85281

+1.480.333.2200

---

## Warranty Policy

Comtech EF Data products are warranted against defects in material and workmanship for a specific period from the date of shipment, and this period varies by product. In most cases, the warranty period is two years. During the warranty period, Comtech EF Data will, at its option, repair or replace products that prove to be defective. Repairs are warranted for the remainder of the original warranty or a 90 day extended warranty, whichever is longer. Contact Comtech EF Data for the warranty period specific to the product purchased.

For equipment under warranty, the owner is responsible for freight to Comtech EF Data and all related customs, taxes, tariffs, insurance, etc. Comtech EF Data is responsible for the freight charges only for return of the equipment from the factory to the owner. Comtech EF Data will return the equipment by the same method (i.e., Air, Express, Surface) as the equipment was sent to Comtech EF Data.

All equipment returned for warranty repair must have a valid RMA number issued prior to return and be marked clearly on the return packaging. Comtech EF Data strongly recommends all equipment be returned in its original packaging.

Comtech EF Data Corporation's obligations under this warranty are limited to repair or replacement of failed parts, and the return shipment to the buyer of the repaired or replaced parts.

## Limitations of Warranty

The warranty does not apply to any part of a product that has been installed, altered, repaired, or misused in any way that, in the opinion of Comtech EF Data Corporation, would affect the reliability or detracts from the performance of any part of the product, or is damaged as the result of use in a way or with equipment that had not been previously approved by Comtech EF Data Corporation.

The warranty does not apply to any product or parts thereof where the serial number or the serial number of any of its parts has been altered, defaced, or removed.

The warranty does not cover damage or loss incurred in transportation of the product. The warranty does not cover replacement or repair necessitated by loss or damage from any cause beyond the control of Comtech EF Data Corporation, such as lightning or other natural and weather related events or wartime environments.

The warranty does not cover any labor involved in the removal and or reinstallation of warranted equipment or parts on site, or any labor required to diagnose the necessity for repair or replacement.

The warranty excludes any responsibility by Comtech EF Data Corporation for incidental or consequential damages arising from the use of the equipment or products, or for any inability to use them either separate from or in combination with any other equipment or products.

A fixed charge established for each product will be imposed for all equipment returned for warranty repair where Comtech EF Data Corporation cannot identify the cause of the reported failure.

## **Exclusive Remedies**

Comtech EF Data Corporation's warranty, as stated is in lieu of all other warranties, expressed, implied, or statutory, including those of merchantability and fitness for a particular purpose. The buyer shall pass on to any purchaser, lessee, or other user of Comtech EF Data Corporation's products, the aforementioned warranty, and shall indemnify and hold harmless Comtech EF Data Corporation from any claims or liability of such purchaser, lessee, or user based upon allegations that the buyer, its agents, or employees have made additional warranties or representations as to product preference or use.

The remedies provided herein are the buyer's sole and exclusive remedies. Comtech EF Data shall not be liable for any direct, indirect, special, incidental, or consequential damages, whether based on contract, tort, or any other legal theory.





# Chapter 1. INTRODUCTION



**UNLESS OTHERWISE NOTED** – This chapter collectively refers to the Comtech EF Data Advanced VSAT Series ODM-840 Remote Router, ODMR-840 Reduced Form Factor Remote Router, and ODMR-840B Remote Router Board Set as the ODM-840.

---

## 1.1 Overview



*ODM-840 Remote Router*



*ODMR-840 Reduced Form Factor Remote Router*



*ODMR-840B Remote Router Board Set*

**Figure 1-1. ODM-840 Remote Routers**

The Comtech EF Data Advanced VSAT ODM-840 Remote Router, the ODMR-840 Reduced Form Factor Remote Router, and the ODMR-840B Remote Router Board Set (**Figure 1-1**) are point-to-multipoint routers designed for outdoor use. These products serve as the “spoke” or remote site equipment component of Comtech EF Data’s Advanced VSAT Series group of products (**Figure 1-2**).

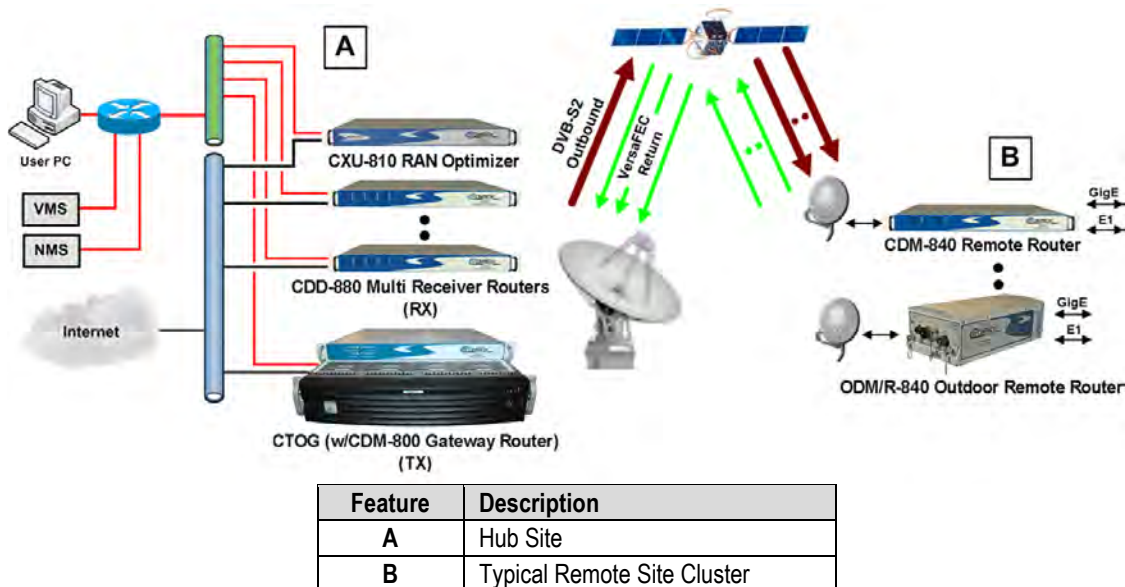

**Figure 1-2. Advanced VSAT Series Network Topology Example**

Comtech’s Advanced VSAT Series products are designed to support latency-sensitive applications such as cellular backhaul over satellite, Universal Service Obligation (USO) networks, corporate networks, Internet Service Providers, and other similar hub-and-spoke network environments that require high-performance, high-quality IP transport with “always-on” availability.

The ODM-840 features a 10/100/1000 Gigabit Ethernet (GigE) interface and provides WAN bandwidth optimization. It also features integrated VersaFEC, a patented system of short-block codes that provide maximum coding gain with lowest possible latency.



- **Sect. 1.3 Product Features**
- **Sect. 1.4.1 Product Specifications**

---

## 1.2 Functional Description

The ODM-840 Remote Router:

- Transmits VersaFEC interoperable with Comtech EF Data's CDD-880 Multi Receiver Router. The receive side supports DVB-S2 operation at L-Band up to 62 Msps, and is compatible with Comtech EF Data's CTOG-250 Comtech Traffic Optimization Gateway with CDM-800 Gateway Router for ACM/VCM (Adaptive Coding and Modulation / Variable Coding and Modulation) operation.
- Features a high performance processor and a real-time operating system (RTOS) combined with multiple Field Programmable Gate Arrays (FPGAs).
- Runs on an embedded operating system in non-volatile Flash memory. It does not have moving parts for media storage.
- Supports reception and transmission of IP data over satellite links via two fundamentally different interfaces – **IF** and **data**:
  - The **IF** interface provides a bidirectional link with the satellite via the uplink and downlink equipment.
  - The **data** interface is a bidirectional path that connects the customer's equipment (assumed to be the **Data Terminal Equipment**, or DTE) to the unit (assumed to be the **Data Communications Equipment**, or DCE). All terrestrial data is connected using the available 10/100/1000 Gigabit Ethernet interface.
- Includes support for ACM (Adaptive Coding and Modulation) and VCM (Variable Coding and Modulation) operation:
  - ACM allows the modulator to automatically and seamlessly adjust the transmitted MODCOD as the environmental conditions change to maintain QEF (Quasi Error Free) operation.
  - VCM allows operators to define groups of remotes on the outbound having different modulation and coding parameters, as a means to improve efficiency on existing satellite capacity.

**On the Tx (transmit) side:** The return modulator transmits IP datagrams and is compatible with Comtech EF Data's CDD-880 Multi Receiver Router(s) located at a hub site.

In the FEC encoder, the data is differentially encoded, scrambled, and then VersaFEC-encoded. Following the encoder, the data is fed to the transmit digital filters, which perform spectral shaping on the data signals. The resultant I and Q signals are then fed to the BPSK, QPSK, 8-QAM, or 16-QAM modulator. The carrier is generated by a frequency synthesizer, and the I and Q signals directly modulate this carrier to produce an IF output signal.

**On the Rx (receive) side:** The DVB-S2 demodulator supports enhanced GSE decapsulation and label filtering for up to 2,047 unique labels.

**DVB-S2 Receiver:** The ODM/R-840's demodulator supports DVB-S2 QPSK, 8-PSK, 16-APSK and 32-APSK demodulation up to 62 Msps, with receive data rates up to 167 Mbps depending on the modulation type and code rate.

In DVB-S2 operation, the receiver automatically operates in ACM/VCM mode. The receiver automatically detects for spectral inversion and pilots ON/OFF, and supports spectral rolloff of 20%, 25% or 35%.



- **Sect. 1.3 Product Features**
- **Sect. 1.4 Product Specifications**
- **Appendix B. FEC (FORWARD ERROR CORRECTION) OPTIONS**

**Monitor and Control Interfaces:** The unit is managed through multiple interfaces providing options for both in-band and out-of-band monitor and control:



- **Sect. 6.2.2 (ETHERNET-BASED REMOTE PRODUCT MANAGEMENT) SNMP Interface**
- **Sect. 6.2.3 (ETHERNET-BASED REMOTE PRODUCT MANAGEMENT) ODM-840 HTTP (Web Server) Interface**
- **Chapter 7. SERIAL-BASED REMOTE PRODUCT MANAGEMENT**

**On-site Firmware Updates:** Field update of the operating system firmware is possible through file upload via satellite or the Ethernet port.



#### **Chapter 4. UPDATING FIRMWARE**

**On-site Operational Upgrades:** Field activation of software-based options is possible through Comtech's FAST (Fully Accessible System Topology) Feature upgrade process.



- **Chapter 5. FAST ACTIVATION PROCEDURE**
- **Sect. 6.3.2.3 (ODM-840 HTTP Interface) Admin | FAST Page**

## 1.3 Product Features

### 1.3.1 Physical Description



- **Sect. 1.4 Product Specifications**
- **Chapter 3. INSTALLATION**

- Both the ODM-840 and ODMR-840 are constructed as fully-contained, weatherproof chassis intended for pole-mounted field installations. The equipment can also be freestanding if desired.
- The ODMR-840B Remote Router Board Set is designed for assembly into a user-provided enclosure.

#### 1.3.1.1 Standard Assemblies (by CEFD P/N)

##### 1.3.1.1.1 ODM-840 Remote Router

Assembly	Description
PL-0000993 KT-0000240 KT-0000233 KT-0000241 PL-0001052	Standard ODM-840 100-240 VAC Base Unit / Connectors Panel, with Finishing Kit, no BUC Power Supply; Standard Temperature Operating Range (0-55°C)

##### 1.3.1.1.2 ODMR-840 Reduced Form Factor Remote Router

Assembly	Description
PL-0020745 KT-0020563 PL-0020557	Standard ODMR-840 Base Unit, with Finishing Kit, no Heater Configuration

##### 1.3.1.1.3 ODMR-840B Remote Router Board Set

Assembly	Description
PL-0021443	Type 'N' with Integrated Power Supply, with Heatsinks
PL-0021445	Type 'SMA' with Integrated Power Supply, with Heatsinks
PL-0020557	Type 'N' with Integrated Power Supply, <i>without</i> Heatsinks
PL-0021154	Type 'SMA' with Integrated Power Supply, <i>without</i> Heatsinks
PL-0021453	Type 'N' <i>without</i> Integrated Power Supply, with Heatsinks
PL-0021455	Type 'SMA' <i>without</i> Integrated Power Supply, with Heatsinks
PL-0021449	Type 'N' <i>without</i> Integrated Power Supply, <i>without</i> Heatsinks
PL-0021451	Type 'SMA' <i>without</i> Integrated Power Supply, <i>without</i> Heatsinks

### 1.3.1.2 Optional Assemblies (by CEFD P/N)

#### 1.3.1.2.1 ODM-840 Remote Router Options

Power Options	
Assembly	Description
KT-0000233 KT-0000234	ODM-840 100-240 VAC unit with 24 VDC 90W @ 50°C BUC Power Supply
KT-0000233 KT-0000235	ODM-840 100-240 VAC unit with 48 VDC 150W @ 50°C BUC Power Supply
KT-0000236	ODM-840 48 VDC Unit, with Finishing Kit, no BUC Power Supply
KT-0000236 KT-0000237	ODM-840 48 VDC Unit, with Finishing Kit , 24 VDC 90W @ 50°C BUC Power Supply
KT-0000236 KT-0000238	ODM-840 48 VDC Unit, with Finishing Kit – w/48 VAC 150W @ 50°C BUC Power Supply

Extended Temperature Range Options		
Assembly	Description	Where Installed
KT-0000241 PL-0001053 FS-0020504	ODM-840 PCB Assembly with Extended Temperature Range (-40° C to 55° C), 120 VAC Input Power	ODM-840 chassis
KT-0000241 PL-0001054 FS-0020504	ODM-840 PCB Assembly with Extended Temperature Range (-40° C to 55° C), 240 VAC Input Power	ODM-840 chassis
KT-0000241 PL-0020721 FS-0020505	ODM-840 PCB Assembly with Extended Temperature Range (-40° C to 55° C), 48 VDC Input Power	ODM-840 chassis

#### 1.3.1.2.2 Installation Kits



### Chapter 3. INSTALLATION

#### 1.3.1.2.2.1 ODM-840 and ODMR-840 Installation Kits

Assembly	Description	Where Installed
KT-0000262	Pole Mounting Kit (Dual Straps)	Antenna Support Pole
KT-0000227	ODM/R-840 Single Unit Mounting Kit	Bottom of ODM/R-840 chassis

## 1.3.2 Dimensional Envelopes

### 1.3.2.1 ODM-840 Dimensional Envelope

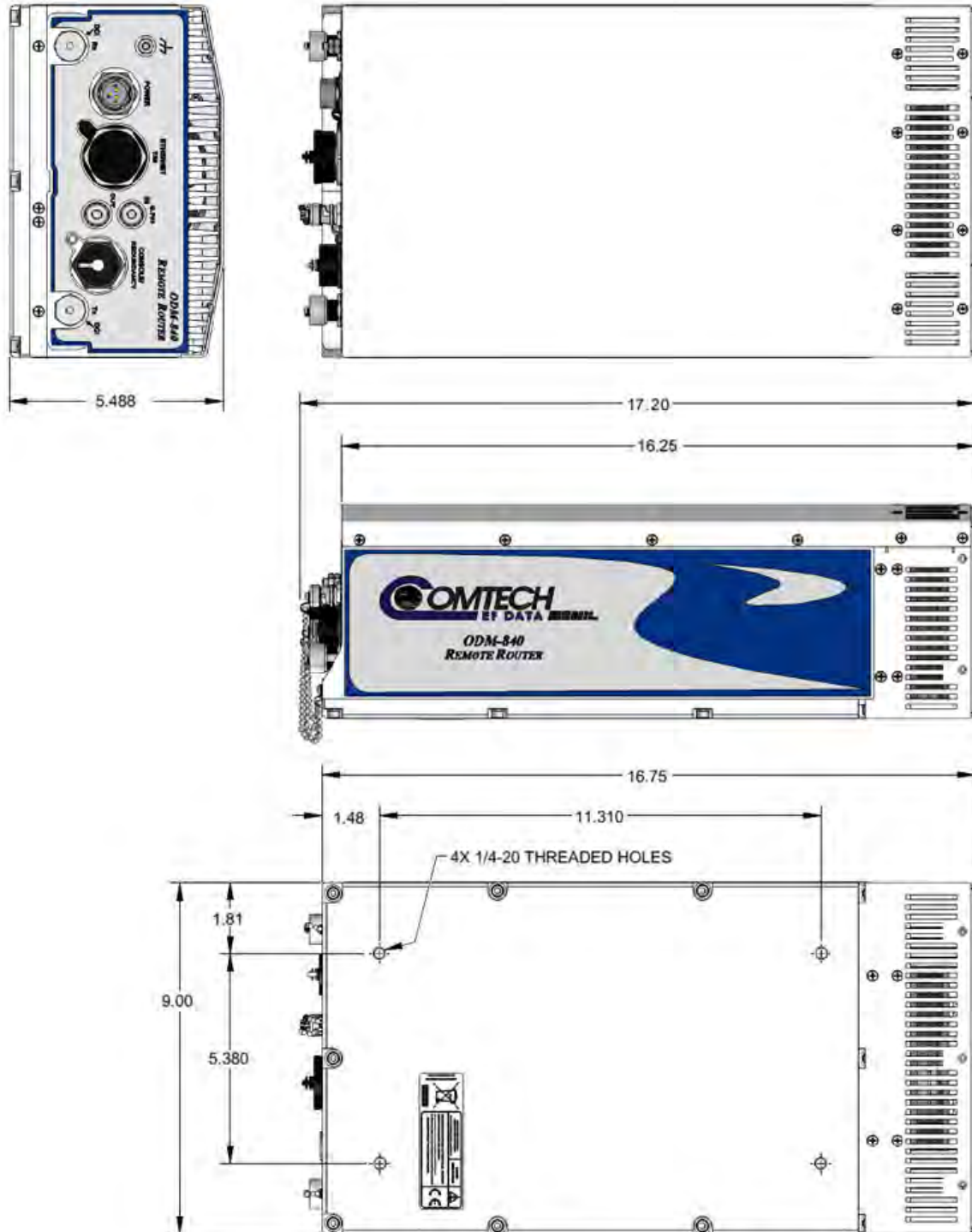

Figure 1-3. ODM-840 Dimensional Envelope

### 1.3.2.2 ODMR-840 Dimensional Envelope

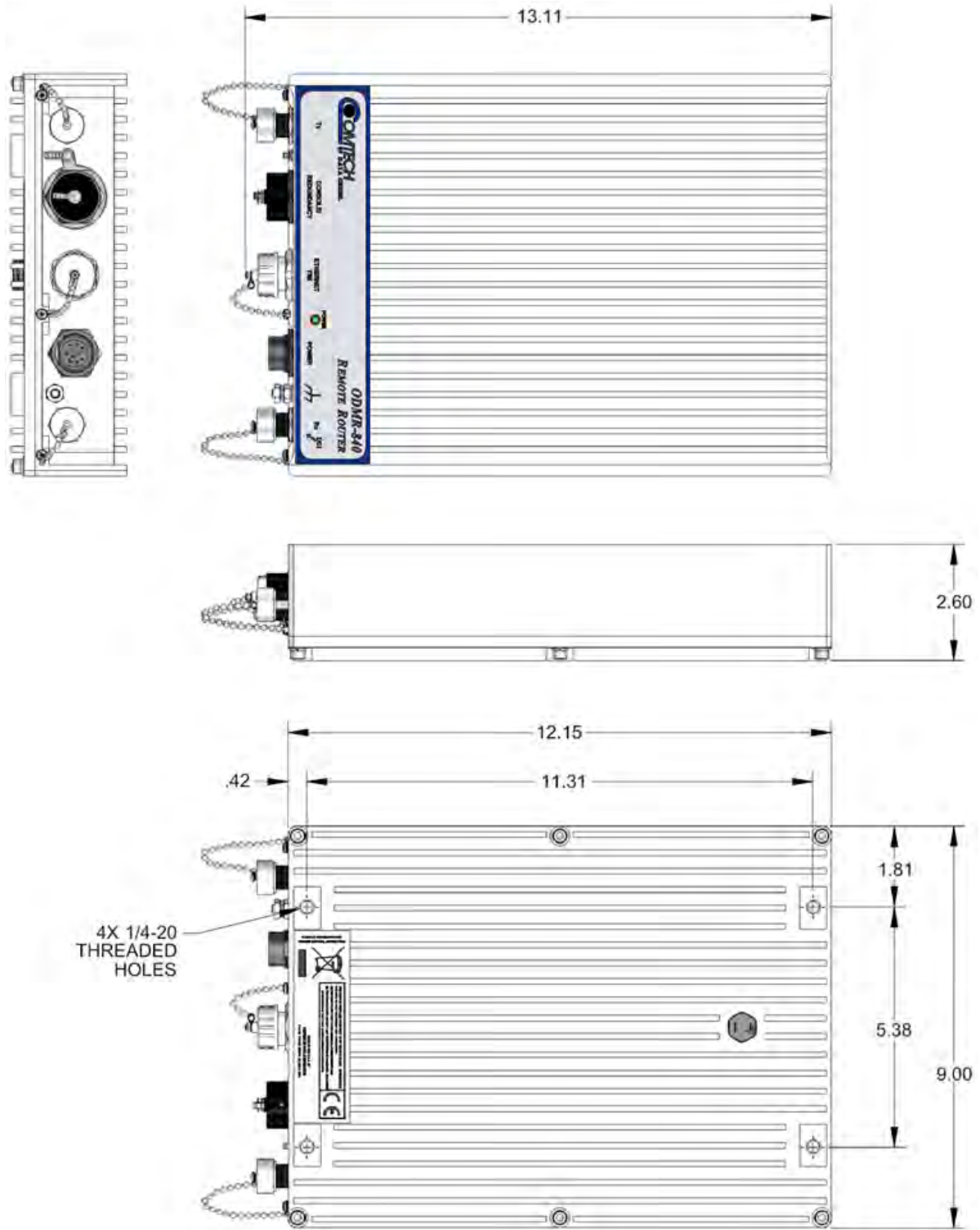

Figure 1-4. ODMR-840 Dimensional Envelope



### 1.3.2.3 ODMR-840B Dimensional Envelopes

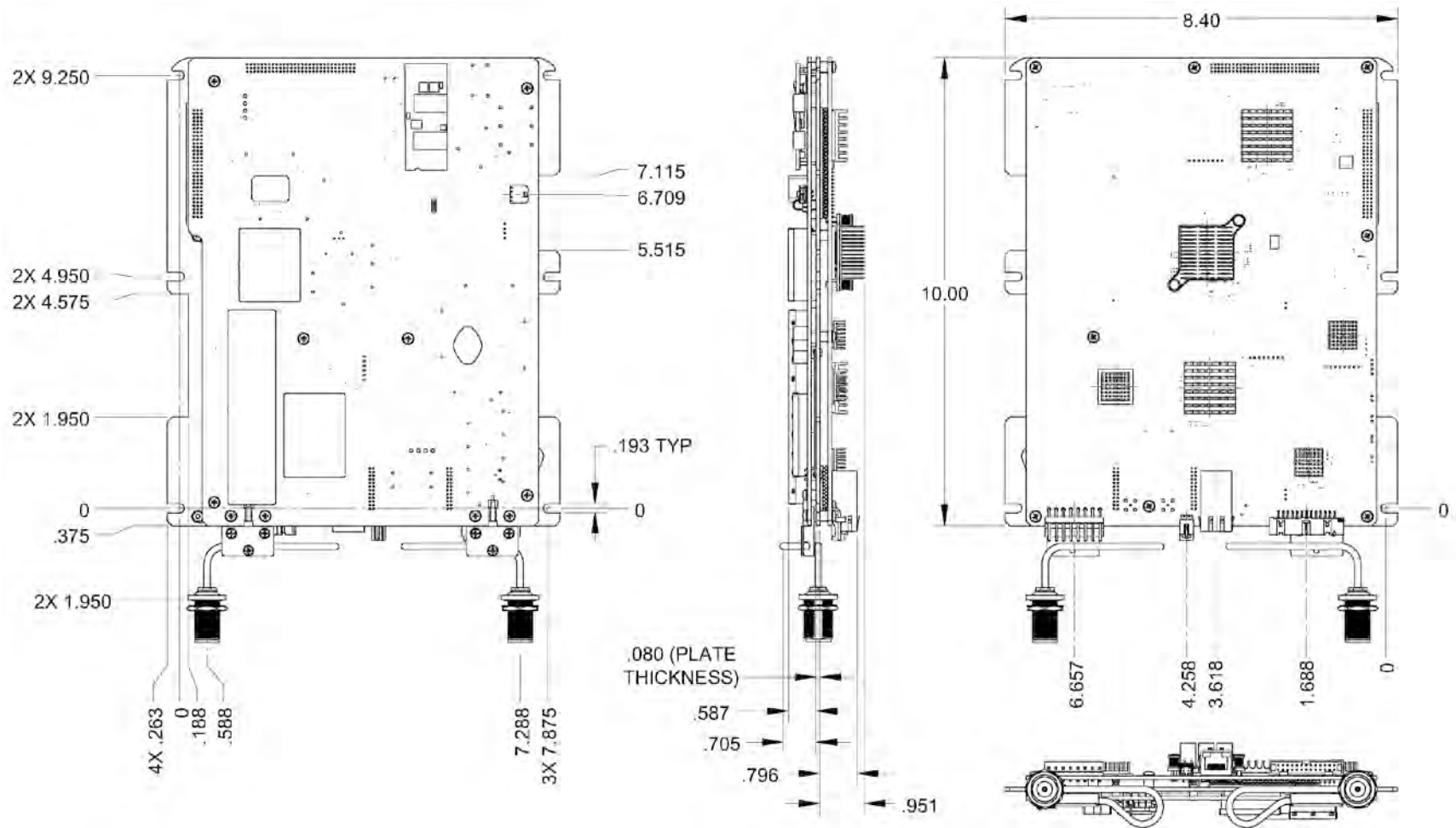

Figure 1-5. ODMR-8490B Board Set Dimensional Envelope – Type ‘N’ Connectors

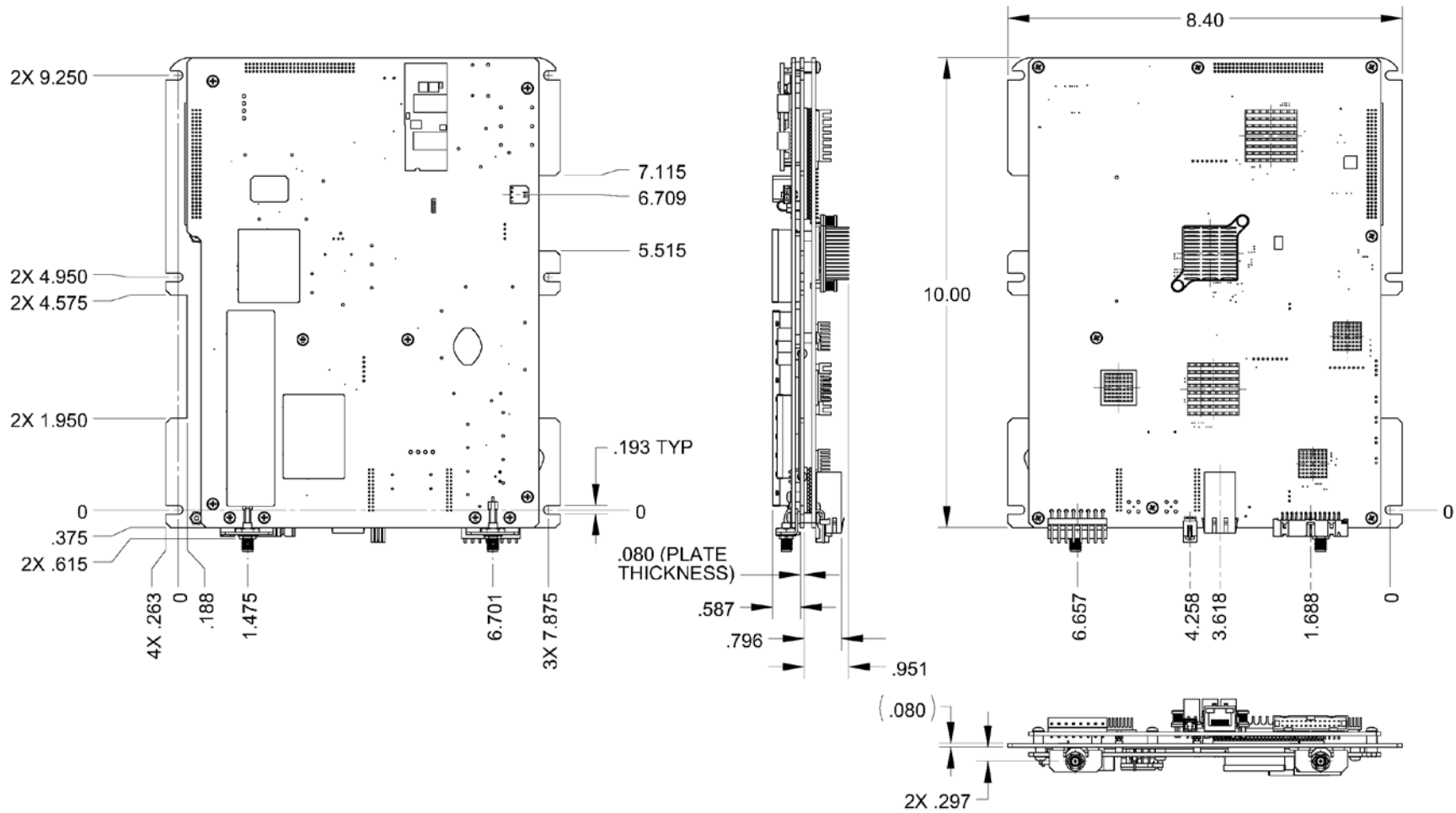

Figure 1-6. ODMR-8490B Board Set Dimensional Envelope – Type ‘SMA’ Connectors

### 1.3.3 Physical Features

#### 1.3.3.1 Connectors Panel



**CAUTION – CONNECT THE UNIT TO A POWER SYSTEM THAT HAS SEPARATE GROUND, LINE AND NEUTRAL CONDUCTORS. DO NOT CONNECT THE UNIT WITHOUT A DIRECT CONNECTION TO GROUND.**



- Sect. 2.3 ODM-840 Fusing, Grounding, and Power Connections
- Sect. 3.3. ODM-840 Cabling



ODM-840 Outdoor Remote Router

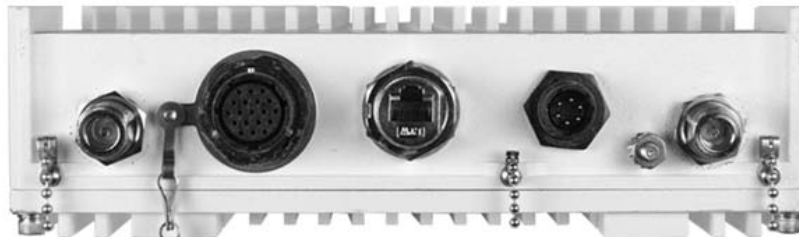

ODMR-840 Reduced Form Factor Outdoor Remote Router

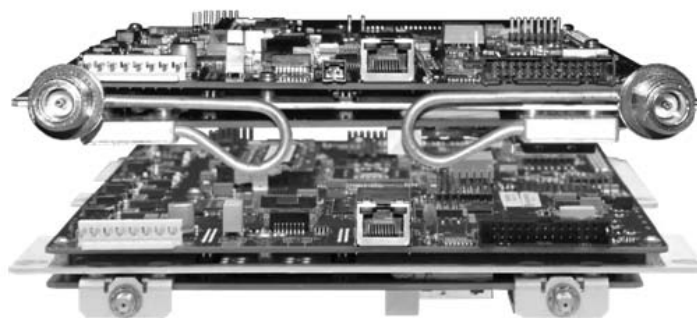

ODMR-840B Outdoor Remote Router Board Set  
(TOP) Type N Connectors Model  
(BOTTOM) Type SMA Connectors Model

**Figure 1-7. Product Connector Interfaces**

Connect external cables to the ODM-840 connector interfaces (**Figure 1-7**). These connections provide power, signal transmit and receive, traffic data transmit and receive, and monitor and control for the unit.

### 1.3.3.1.1 Connectors Panel Standard Features

As per **Figure 1-7**:

#### Power Interface:

- **ODM-840** – 100-240 VAC Primary Input Power Supply (no heater, no Block Up Converter (BUC) Power Supply).
- **ODMR-840** – -24 or -48 VDC Primary Input Power Supply.
- **ODMR-840B Board Set** – -24 or -48 VDC Integrated Power Supply **or** +5/±12 VDC Discrete Power Supply.

#### Data Interfaces:

- **'ETHERNET|T/M'** Interface – (1X) 10/100/1000 BaseT Gigabit Ethernet RJ-45 Interface for Ethernet traffic as well as remote product management and control purposes (HTTP/Web and SNMP).
- **'CONSOLE/REDUNDANCY'** Interface:
  - **ODM-840** – (1X) EIA-232 19-pin circular connector, for serial remote product management **or** 1:1 redundant control when two ODM-840 units are connected to an optional Comtech EF Data 1:1 Redundancy Switch.
  - **ODMR-840** – (1X) EIA-232 19-pin circular connector, for serial remote product management **only**.
  - **ODMR-840B Board Set** – (1X) EIA-232 26-pin board-mounted header for serial remote product management **only**.

#### IF Interfaces:

- **ODM/R-840** – (2X) Type 'N' female connectors for 50Ω L-Band (950 to 2150 MHz).
- **ODMR-840B Board Set** – (2X) Type 'N' **or** Type 'SMA' female connectors for 50Ω L-Band (950 to 2150 MHz).

### 1.3.3.1.2 Connectors Panel Optional Features (ODM-840 Only)

The ODM-840 provides the following data interfaces for optional FAST-enabled operation:

- (2X) Type 'BNC' female connectors labeled '**G.703 | IN/OUT**' are provided for operation of the optional G.703 E1 Interface/RAN Optimization Hardware/FAST Feature upgrade.



**This interface is not available on the ODMR-840 or ODMR-840B.**

The following power interface options are available for the ODM-840:

- 100-240 VAC w/24 VDC 90W @ 50°C BUC Power Supply
- 100-240 VAC w/48 VDC 150W @ 50°C BUC Power Supply
- 48 VDC (no BUC Power Supply)
- 48 VDC w/24 VDC 90W @ 50°C BUC Power Supply
- 48 VDC w/48 VDC 150W @ 50°C BUC Power Supply

## 1.4 Specifications

### 1.4.1 Product Specifications

Specification		Description
Data Interfaces		<ul style="list-style-type: none"> <li>1X RJ-45 10/100/1000 BaseT Gigabit Ethernet</li> <li>1X EIA-232 19-pin circular connector interface for serial remote control (<b>ODM/R-840</b>) and 1:1 Redundancy (<b>ODM-840 only</b>)</li> <li>2X G.703 E1, 2.048 Mbps (BNC-F Unbalanced 75Ω) (<b>ODM-840 only</b>)</li> <li>1X EIA-232 26-pin header for serial remote control (<b>ODMR-840B only</b>)</li> </ul>
Dimensional Envelope		<b>ODM-840:</b> 9 W x 5.5 H x 16.75 D inches (227 W x 139 H x 422 D mm) <b>ODMR-840:</b> 9 W x 2.8 H x 13 D inches (227 W x 71.1H x 330 D mm) <b>ODMR-840B:</b> 8.5 W x 10.5 H x 1.6 D inches (216 W x 267 H x 41 D mm)
Weight		<b>ODM-840:</b> 22 lbs (9.98 kg) <b>ODMR-840:</b> 10.3 lbs (4.67 kg) <b>ODMR-840B:</b> 2.4 lbs (1.09 kg)
Power Supply	AC	<b>ODM-840:</b> 100V to 240V AC, 47-63 Hz without heater installed 110V with 110V heater installed 220V with 220V heater installed
	DC	<b>ODM-840:</b> -48 VDC (HW option) <b>ODMR-840:</b> -24 VDC or -48 VDC <b>ODMR-840B:</b> -24 or -48 VDC Integrated Power Supply or +5/±12 VDC Discrete Power Supply.
Temperature	Operating	<b>Under normal operation:</b> <b>ODM-840:</b> 0° C (32° F) to 55° C (131° F). <b>ODMR-840:</b> -20° C (-4° F) to 55° C (131° F) <b>ODMR-840B (in customer enclosure):</b> -20° C (-4° F) to 60° C (140° F) <b>When equipped with the Extended Temperature HW Option:</b> <b>ODM-840:</b> -40° C (-40° F) to 55° C (131° F).
	Storage	-40° C (-40° F) to 70° C (158° F)
Humidity		95% maximum, non-condensing
Vibration	Operating	<ul style="list-style-type: none"> <li>MIL-STD-810G, Three (3) axis exposure</li> <li>Method 514.6 Procedure I, Category 14, Rotary Wing Aircraft Profiles (<i>modified</i>)</li> </ul>
	Non-operating	<ul style="list-style-type: none"> <li>MIL-STD-810G, Three (3) axis exposure</li> <li>Method 514.6 Procedure I, Category 4, Composite Wheeled Profiles (<i>modified</i>)</li> </ul>
Shock	Operating	<ul style="list-style-type: none"> <li>MIL-STD-810G, Three (3) axis exposure</li> <li>Method 516.6 Procedure I, 20G Maximum Pulse</li> </ul>
	Non-operating	<ul style="list-style-type: none"> <li>MIL-STD-810G, Three (3) axis exposure</li> <li>Method 516.6 Procedure I, 40G Maximum Pulse (<i>modified</i>)</li> </ul>
Operating Frequency	Tx	950 – 2150 MHz (L-Band)
	Rx	
Connectors & Impedance	Tx	<b>ODM-840 or ODMR-840:</b> Type 'N' female, 50 Ω
	Rx	<b>ODMR-840B only:</b> Type 'SMA' female, 50 Ω
Transmit Power		0 to -40 dBm
BUC (ODM-840 only)	Reference (10 MHz)	10.0 MHz ± 0.06 ppm, selectable ON/OFF, 0.0 dBm ± 3 dB
	Power Supply (HW Option)	<ul style="list-style-type: none"> <li>24 VDC, 3.75 Amps max., 90 W @ 50° C;</li> <li>48 VDC, 3.125 Amps max., 150 W @ 50° C</li> </ul>

Specification		Description
LNB	Reference (10 MHz)	10.0 MHz $\pm$ 0.06 ppm, Selectable ON/OFF, $-3.0$ dBm $\pm$ 3 dB
	Voltage	Selectable ON/OFF, 13V DC, 18V DC and 24V DC
	Current	500 mA, maximum
Rx Monitoring		Es/No estimate, Receive Signal Level, Frequency Offset, BER, I&Q Constellation ( <b>FUTURE</b> )
Adaptive Equalizer		5-tap, selectable, corrects up to 3 dB tilt
Acquisition Range		$\pm$ 100 kHz
Supported Protocols		<ul style="list-style-type: none"> <li>• RFC 768 – UDP</li> <li>• RFC 791 – IP</li> <li>• RFC 792 – ICMP</li> <li>• RFC 793 – TCP</li> <li>• RFC 826 – ARP</li> <li>• RFC 856 – Telnet</li> <li>• RFC 862 – Ping</li> <li>• RFC 894 – IP</li> <li>• RFC 959 – FTP</li> <li>• RFC 1112 – IP Multicast</li> <li>• RFC 1213 – SNMP MIB II</li> <li>• RFC 1812 – IPv4 Routers</li> <li>• RFC 2045 – MIME</li> <li>• RFC 2474 – DiffServ</li> <li>• RFC 2475 – DiffServ</li> <li>• RFC 2578 – SMI</li> <li>• RFC 2597 – AF PHB</li> <li>• RFC 2598 – Expedite Forwarding</li> <li>• RFC 2616 – HTTP</li> <li>• RFC 3412 – SNMP</li> <li>• RFC 3416 – SNMPv2</li> <li>• RFC 3418 – SNMP MIB</li> </ul>

Specification	Description	
	Outbound (Hub to Remote)	Return (Remote to Hub)
Data Rate	1 – 168 Mbps	16 kbps – 15.35 Mbps
Symbol Rate	1 – 62 Msps (QPSK, 8-PSK) 1 – 47 Msps (16-APSK, 32-APSK)	16 ksps – 4.5 Msps
FEC	DVB-S2	VersaFEC
Modulation and Code Rates	<ul style="list-style-type: none"> <li>• QPSK 1/4 0.479 – 29.672 Mbps</li> <li>• QPSK 1/3 0.641 – 39.731 Mbps</li> <li>• QPSK 2/5 0.771 – 47.779 Mbps</li> <li>• QPSK 1/2 0.965 – 59.850 Mbps</li> <li>• QPSK 3/5 1.160 – 71.922 Mbps</li> <li>• QPSK 2/3 1.291 – 80.029 Mbps</li> <li>• QPSK 3/4 1.452 – 90.029 Mbps</li> <li>• QPSK 4/5 1.549 – 96.064 Mbps</li> <li>• QPSK 5/6 1.615 – 100.148 Mbps</li> <li>• QPSK 8/9 1.724 – 106.914 Mbps</li> <li>• QPSK 9/10 1.749 – 108.255 Mbps</li> <li>• 8-PSK 3/5 1.740 – 107.853 Mbps</li> <li>• 8-PSK 2/3 1.936 – 120.011 Mbps</li> <li>• 8-PSK 3/4 2.178 – 135.007 Mbps</li> <li>• 8-PSK 5/6 2.422 – 150.181 Mbps</li> <li>• 8-PSK 8/9 2.586 – 160.000 Mbps</li> <li>• 8-PSK 9/10 2.618 – 160.000 Mbps</li> <li>• 16-APSK 2.575 – 121.007 Mbps</li> <li>• 16-APSK 2.896 – 136.217 Mbps</li> <li>• 16-APSK 3.090 – 145.253 Mbps</li> <li>• 16-APSK 3.222 – 151.428 Mbps</li> <li>• 16-APSK 3.440 – 160.000 Mbps</li> <li>• 16-APSK 3.483 – 160.000 Mbps</li> <li>• 32-APSK 3.623 – 134.063 Mbps</li> <li>• 32-APSK 3.866 – 143.051 Mbps</li> <li>• 32-APSK 4.031 – 149.132 Mbps</li> <li>• 32-APSK 4.303 – 159.207 Mbps</li> <li>• 32-APSK 4.357 – 160.000 Mbps</li> </ul>	<ul style="list-style-type: none"> <li>• BPSK 0.488 (16.00 kbps – 2.19 Mbps)</li> <li>• QPSK 0.533 (17.07 kbps – 4.80 Mbps)</li> <li>• QPSK 0.631 (20.19 kbps – 5.67 Mbps)</li> <li>• QPSK 0.706 (22.577 kbps – 6.34 Mbps)</li> <li>• QPSK 0.803 (25.69 kbps – 7.22 Mbps)</li> <li>• 8-QAM 0.642 (30.83 kbps – 8.67 Mbps)</li> <li>• 8-QAM 0.711 (34.14 kbps – 9.60 Mbps)</li> <li>• 8-QAM 0.780 (37.44 kbps – 10.53 Mbps)</li> <li>• 16-QAM 0.731 (46.80 kbps – 13.26 Mbps)</li> <li>• 16-QAM 0.780 (49.92 kbps – 14.04 Mbps)</li> <li>• 16-QAM 0.829 (53.04 kbps – 14.91 Mbps)</li> <li>• 16-QAM 0.853 (54.60 kbps – 15.35 Mbps)</li> </ul>
Rolloff	20%, 25% and 35%	20%, 25% and 35%
Encapsulation	Enhanced GSE	Streamline Encapsulation (SLE)

### 1.4.2 BER (Bit Error Rate)

Specification	Description				
<b>Monitor Functions</b>	<ul style="list-style-type: none"> <li>• Eb/No estimate: 3 to 12 dB with <math>\pm 0.5</math> dB accuracy</li> <li>• Corrected Bit Error Rate: 1E-3 to 1E-9</li> <li>• Frequency offset: <math>\pm 32</math> kHz range, 100 Hz resolution</li> <li>• Signal Strength Indicator: 0-60 dB range relative to maximum gain</li> </ul>				
<b>VersaFEC CODEC BER</b> (With two adjacent carriers, each 7 dB higher than the desired carrier)	<b>For: BER=10<sup>-x</sup></b>	<b>Guaranteed Eb/No, in dB (typical value in parentheses):</b>			
		<b>Rate 0.488 BPSK</b>			
	BER=10 <sup>-5</sup>	2.4 (2.1)			
	BER=10 <sup>-8</sup>	2.7 (2.4)			
		<b>Rate 0.533 QPSK</b>	<b>Rate 0.631 QPSK</b>	<b>Rate 0.706 QPSK</b>	<b>Rate 0.803 QPSK</b>
BER=10 <sup>-5</sup>	2.3 (2.0)	2.8 (2.5)	3.3 (3.0)	3.8 (3.5)	
BER=10 <sup>-8</sup>	2.5 (2.2)	3.0 (2.7)	3.7 (3.4)	4.1 (3.8)	
	<b>Rate 0.642 8QAM</b>	<b>Rate 0.711 8QAM</b>	<b>Rate 0.780 8QAM</b>		
BER=10 <sup>-5</sup>	4.6 (4.3)	5.2 (4.9)	5.6 (5.3)		
BER=10 <sup>-8</sup>	4.9 (4.6)	5.5 (5.2)	6.0 (5.7)		
	<b>Rate 0.731 16QAM</b>	<b>Rate 0.780 16QAM</b>	<b>Rate 0.829 16QAM</b>	<b>Rate 0.853 16QAM</b>	
BER=10 <sup>-5</sup>	6.4 (6.1)	7.0 (6.7)	7.5 (7.2)	8.0 (7.7)	
BER=10 <sup>-8</sup>	6.6 (6.3)	7.3 (7.0)	7.8 (7.5)	8.3 (8.0)	

### 1.4.3 Regulatory Compliance

Specification	Description
<b>"CE" as follows:</b>	<ul style="list-style-type: none"> <li>• EN 301 489-1 (ERM)</li> <li>• EN 55022 Class B (Emissions)</li> <li>• EN 55024 (Immunity)</li> <li>• EN 61000-3-2</li> <li>• EN 61000-3-3</li> <li>• EN 60950 (Safety)</li> </ul>
<b>FCC</b>	FCC Part 15 Subpart B
<b>RoHS Compliance</b>	Yes



# Chapter 2. ODM-840 CONNECTIONS



**UNLESS OTHERWISE NOTED** – This chapter collectively refers to the Comtech EF Data Advanced VSAT Series ODM-840 Remote Router, ODMR-840 Reduced Form Factor Remote Router, and ODMR-840B Remote Router Board Set as the ODM-840.

---





## 2.1 Overview – Cabling Connections Types

Comtech EF Data's Advanced VSAT Series group of products, including the ODM-840, and ODMR-840 Remote Routers, and the ODMR-840B Remote Router Board Set, use a number of different cables. Each cable type is typically dedicated to a specific mode of operation.



- 1) **Not all of the operational interface types described in this overview may be available.**
- 2) **The European EMC Directive (EN55022, EN50082-1) requires using properly shielded cables for DATA I/O. These cables must be double-shielded from end-to-end, ensuring a continuous ground shield.**

## 2.1.1 Coaxial Cable Connections

Coupling Type	Connector Type	
	Plug	Jack
Bayonet (Type 'BNC' shown)		
Threaded (Type 'N' shown)		

**Figure 2-1. Coaxial Connector Examples**

The types of coaxial cables used by Comtech EF Data are 'BNC', 'TNC', 'N', 'F', and 'SMA'. Coaxial cables (plugs) and their mating connectors (jacks/sockets) are available in two coupling styles: **Bayonet** or **Threaded**:

- **Bayonet Coupling Style:** The jack has a pair of guide posts that accommodate the plug's lockdown slots. This lockdown design provides secure assembly without over-tightening the connection.
- **Threaded Coupling Style:** The jack features external threads. The plug shell features internal threads, and has either a knurled outer surface to permit hand-tightening of the connection, or hex flats to accommodate torqued installation.

**Connection Instructions:**

- **Bayonet Coupling Connections:** Use the plug slots to guide, then slide the plug onto the jack posts. Then, turn the plug clockwise until the jack posts are fully seated within the plug slot.
- **Threaded Coupling Connections:** Engage the plug onto the jack threads, and then turn the plug clockwise until it is fully threaded onto the jack. Do not over-tighten the connection.

---

### 2.1.1.1 Type 'BNC'

BNC plugs and jacks feature a **Bayonet Coupling** design.



---

### 2.1.1.2 Type 'TNC'

TNC plugs and jacks feature a **Threaded Coupling** design similar to Type 'N', Type 'F', and Type 'SMA' connectors.

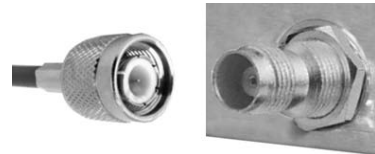

---

### 2.1.1.3 Type 'N'

Type 'N' connectors feature a **Threaded Coupling** design similar to Type 'TNC', Type 'F', and Type 'SMA' connectors.

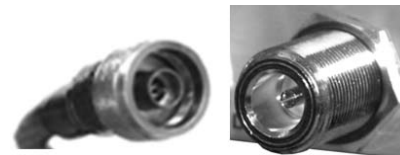

---

### 2.1.1.4 Type 'F'

Type 'F' connectors feature a **Threaded Coupling** design similar to Type 'TNC', Type 'N', and Type 'SMA' connectors.



---

### 2.1.1.5 Type 'SMA' (Subminiature Version 'A')

Type 'SMA' connectors feature a **Threaded Coupling** design similar to Type 'TNC', Type 'N', and Type 'F' connectors.

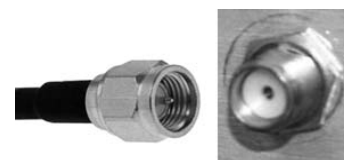

## 2.1.2 D-Subminiature Cable Connections

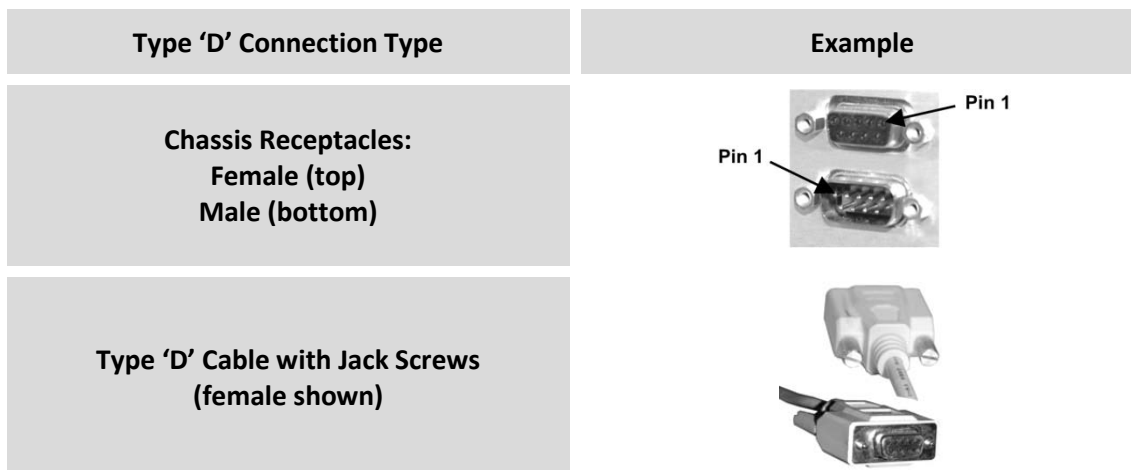

**Figure 2-2. D-Subminiature Connector Examples**

D-Subminiature connectors are also called **Type 'D'** or **'D-Sub'** connectors. The connector pair features multiple rows of pins (male side) coupled to mating sockets (female side). The cable plug and chassis receptacle each feature a D-shaped profile that interlock to ensure proper pin orientation and connector seating.

Either chassis receptacle gender features two jack nuts for secure assembly of the cable plug to the chassis receptacle.

Whether its gender is male or female, the cable plug features two jack screws for secure connection to the jack nuts provided on the mating chassis receptacle. The jack screws may be hand tightened or tightened with a standard flat-blade screwdriver.

**Connection Instructions:** Orient the plug to the receptacle in the proper position. Press firmly into place. Use the jack screws to secure the plug to the receptacle jack nuts. Do not over-tighten.

**About connector pinout tables:** Figure 2-2 identifies the Pin 1 location for either gender connector. Unless noted otherwise, connector pinout tables provided in Comtech EF Data manuals arrange/order information (i.e., the Pin # column/row) based on this orientation.

## 2.1.3 RJ-45, RJ-48 Cable Connections

The plug for an RJ-45 or RJ-48 cable features a flexible tab. The RJ-45 or RJ-48 jack features a mating slot. This design configuration assures proper installation and pin orientation.

**Connection Instructions:** Press down the tab on the cable plug, and then insert the plug into the RJ-4x jack. The connection is complete when the tab 'clicks' into position inside the jack.



## 2.1.4 Circular Cable Connections

Circular connectors are intended for weatherproof outdoor applications. The mated connector pairs feature a sleeve lock configuration, with an array of pins (male side) coupled to mating sockets (female side).

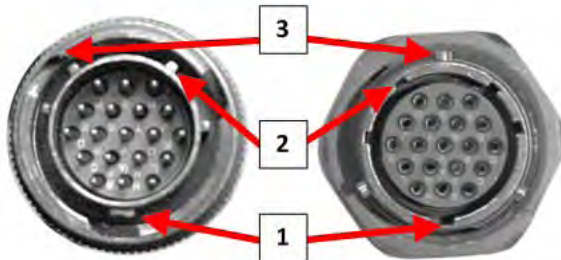

Feature	Description
1	Primary Alignment features
2	Secondary Alignment features
3	Sleeve Lock features

**Connection Instructions:** Engage all of the alignment and lock features between the male connector (on the interconnection cable) and female socket (e.g., the ODM/R-840 CONSOLE/REDUNDANCY port or the POWER port).

Do these steps to install the male connector into the female connector:

1. Engage the primary and secondary alignment tabs on the male connector with the mating cutouts on the female socket.
2. Push the male connector into the female socket.
3. Turn the male connector sleeve clockwise until the sleeve lock cutouts engage fully with the female socket tabs and you hear a “click” sound.

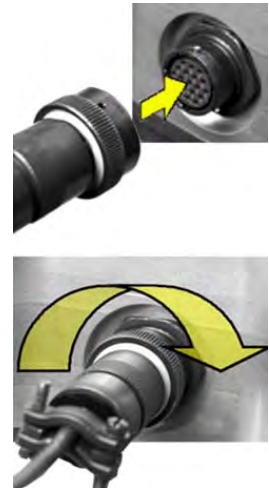

## 2.1.5 ODMR-840B Header Connections

Header Connection Type	Example
<p>User to Chassis Connection: Keyed Female Socket (TOP) Male Header (BOTTOM)</p>	<p>User Cable</p> <p>Header (p/o Board Assembly)</p>

Figure 2-3. Header Connection Examples

Header connections are provided on the ODMR-840 Remote Router Board Set for connection of the power and control interfaces within a user-supplied weatherproof enclosure. The connection is typically comprised of a header connector soldered to the board, coupled with the appropriate user-provided keyed cable connector (**Figure 2-3**). The ODMR-840B header connectors are shown in **Figure 2-4**.

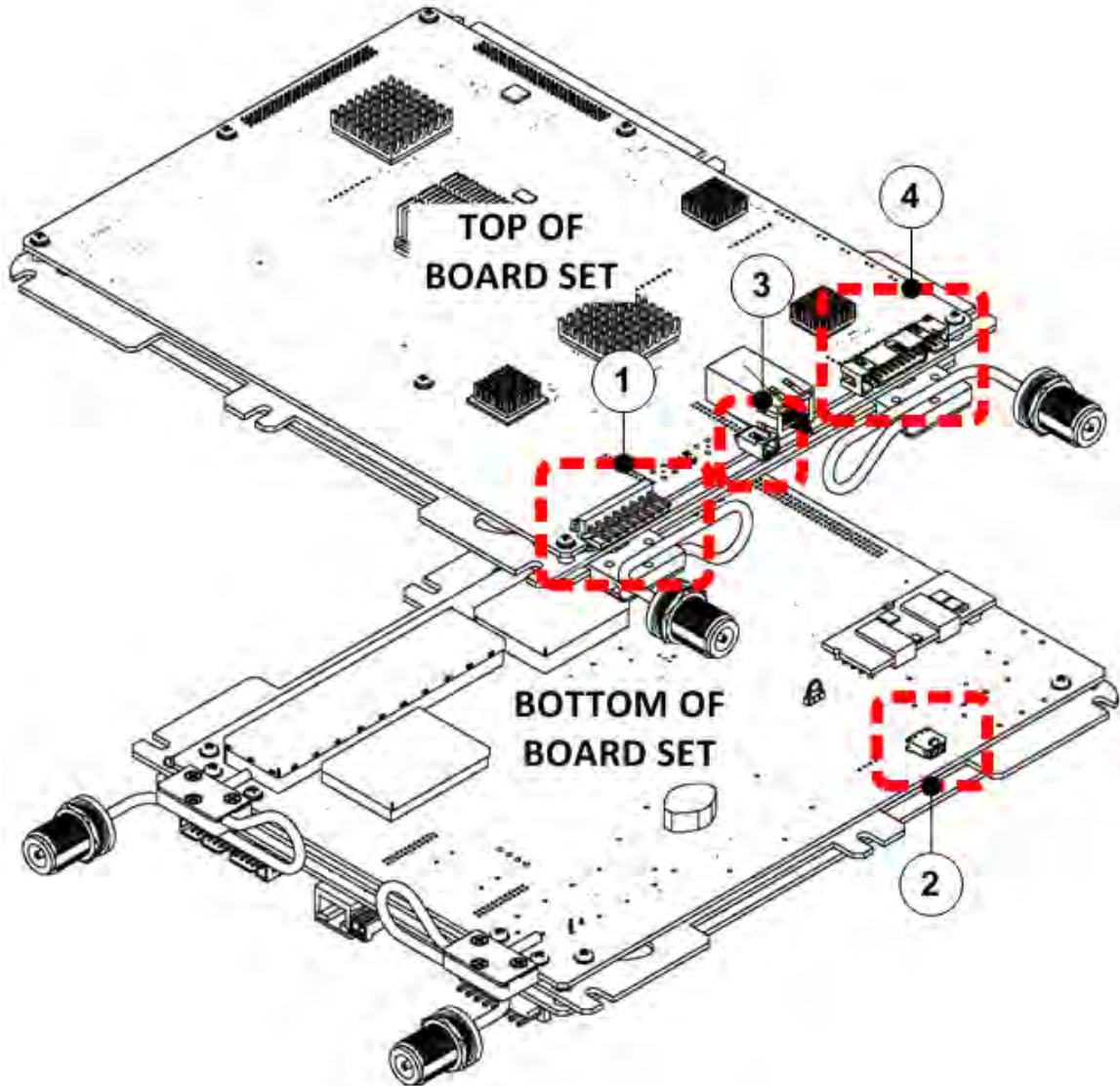

Item	Description	Chapter Section
1	Discrete DC Power 8-Pin Header	2.3.3.2.2
2	Integrated DC Power 2-Pin Header	
3	LED Connection 2-Pin Header	N/A
4	Console/Redundancy 26-pin Header	2.2.3.3

**Figure 2-4. ODMR-840B Header Connectors**

## 2.2 ODM-840 Cabling Connections

The ODM-840 connectors (**Figure 2-5**) provide all necessary external connections between the unit and other equipment.

**Table 2-1** summarizes the available connectors, grouped according to service function.



ODM-840 Remote Router

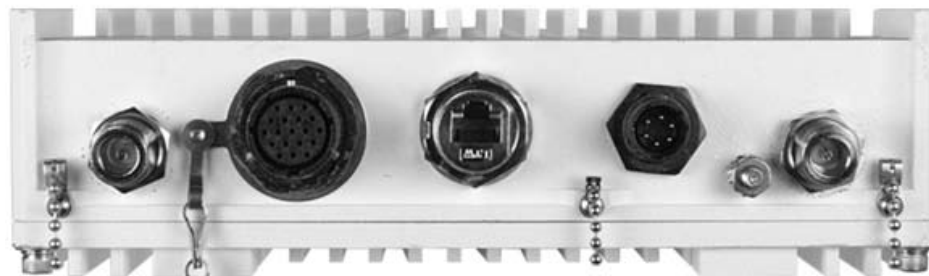

ODMR-840 Reduced Form Factor Remote Router



ODMR-840B Remote Router Board Set  
(TOP) Type N Connectors Model  
(BOTTOM) Type SMA Connectors Model

**Figure 2-5. ODM-840 Connectors**

**Table 2-1. ODM-840 Connectors**

Connector Group	Name	Connector Type	Function	
IF Group Sect. 2.2.1	Rx	50Ω Type 'N' female <b>(ODMR-840B option)</b>	L-Band Input	
		50Ω Type 'SMA' female <b>(ODMR-840B only)</b>		
	Tx	50Ω Type 'N' female <b>(ODMR-840B option)</b>	L-Band Output	
		50Ω Type 'SMA' female <b>(ODMR-840B only)</b>		
Terrestrial Data Group Sect. 2.2.2	ETHERNET T/M (Traffic/Management)		10/100/1000 BaseT Gigabit Ethernet interface (IEEE 802.3ab) and Ethernet management/data interface (IEEE 802.3u)	
	G.703 <b>(ODM-840 only)</b>	IN	BNC Female	G.703 E1 Input
		OUT	BNC Female	G.703 E1 Output
Utility Group Sect. 2.2.3	CONSOLE/REDUNDANCY		19-pin Circular Connector - Female <b>(ODM/R-840)</b>	EIA-232 Serial Remote Interface
			26-pin Header – Male <b>(ODMR-840B)</b>	<b>Note:</b> 1:1 Redundancy is a functional offering only for the ODM-840.



**See Sect. 2.1 Overview – Cabling Connections Types for information about each connector type and its connection instructions.**



## 2.2.1 IF Connectors Group



**THERE MAY BE DC VOLTAGES PRESENT ON THE IF CONNECTORS. SEE THE TABLES FOR EACH CONNECTOR'S VOLTAGE RATING.**

### 2.2.1.1 Type 'N' IF Connector 'Rx'

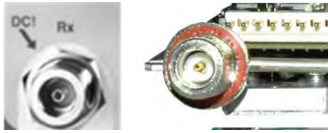

Connector Type	Name	Description	Signal Direction	DC Voltage
Type 'N' 50Ω Female (Optional on ODMR-840B)	Rx	Rx IF Signal, L-Band	Input	24V MAX (TYPICAL)

### 2.2.1.2 Type 'N' IF Connector 'Tx'



Connector Type	Name	Description	Signal Direction	DC Voltage
Type 'N' 50Ω Female (Optional on ODMR-840B)	Tx	Tx IF Signal, L-Band	Output	48V MAX (TYPICAL)

### 2.2.1.3 Type 'SMA' IF Connector 'Rx' (ODMR-840B only)



Connector Type	Name	Description	Signal Direction	DC Voltage
Type 'SMA' 50Ω Female (Standard)	Rx	Rx IF Signal, L-Band	Input	24V MAX

### 2.2.1.4 Type 'SMA' IF Connector 'Tx' (ODMR-840B only)



Connector Type	Name	Description	Signal Direction	DC Voltage
Type 'SMA' 50Ω Female (Standard)	Tx	Tx IF Signal, L-Band	Output	48V MAX

## 2.2.2 Terrestrial Data Connector Group

### 2.2.2.1 'ETHERNET T/M' (Traffic/Management) Connector

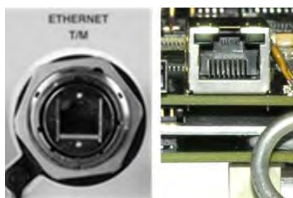

Connector Type	Name	Direction
RJ-45 female modular jack	ETHERNET T/M	In/Out



- This interface operates at 10/100/1000 Mbps, auto-negotiating, half and full duplex.
- The maximum Ethernet packet size is 1522 bytes (including Ethernet headers and CRC).
- Mating connector notes:
  - For the ODM-840 – The chassis socket is CEFD P/N CN/RJF71N (Amphenol Corp. P/N RJF71N). Its mating connector, CEFD P/N RJF-6B (Amphenol Corp. P/N RJF-6B), is available as part of CEFD ODM-840 AC Cable Kit KT-0000263 or DC Cable Kit Kt-0020566.

Note that assembly of this connector, as part of any user-fabricated cable, must conform to Amphenol 'Code A' specification.

  - For the ODMR-840 – The chassis socket is CEFD P/N PP-0020513 (LTW Technology Co. P/N LTWRJS-5EPFFJ-SC7009). Its mating connector, CEFD P/N CN-0020514 (LTW Technology Co. P/N LTWRJ-00BMMA-SL7006), is available as part of CEFD ODMR-840 DC Cable Kit KT-0020567.
  - For the ODMR-840B Board Set – The board socket is CEFD P/N CN/RJ45RAJK14 (Bel Fuse P/N 0826-1G1T-43-F). Use a standard CAT5 RJ45 Ethernet Network Cable as the mating connector.

### 2.2.2.2 'G.703 | IN' / 'G.703 | OUT' Connectors, BNC (ODM-840 only)



Connector Type	Name	Direction
BNC female	G.703   IN	In
	G.703   OUT	Out

## 2.2.3 Utility Connector Group

### 2.2.3.1 'CONSOLE/REDUNDANCY' Connector



- 1) This is the primary input for controlling and monitoring the ODM-840 in standalone (single thread) operation or, for the ODM-840 only, 1:1 redundant operations. See Table 2-2 and Table 2-3 for the connection pinouts.
- 2) An analog signal is provided to aid antenna pointing or for driving step-track equipment. This signal is provided on Pin 'T' of the ODM/R-840 connector, or Pin 'JP5-17' on the ODMR-840B header.

The analog signal will be 0V (zero volts) when the unit is not locked to a carrier. When locked to a carrier, the analog signal will be 1V (one volt) for Es/No values less than or equal to -4.69 dB, or 10V (ten volts) for Es/No values greater than or equal to 20 dB as depicted in the following chart:

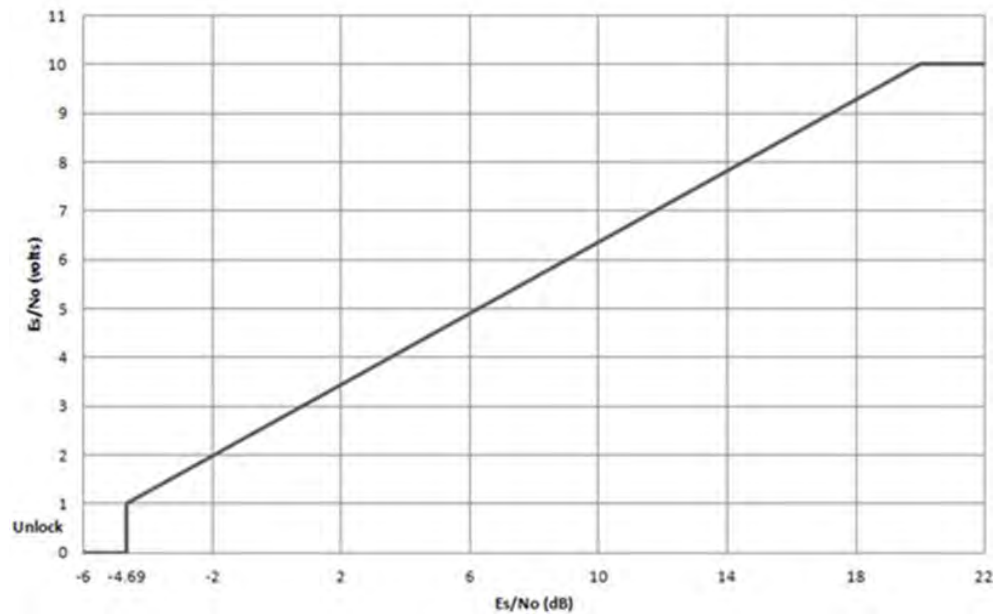

### 2.2.3.2 ODM/R-840 'CONSOLE/REDUNDANCY' Connector



Connector Type / Part No.	Name	Direction
19-pin circular connector (Type MS3112E14-19S)	CONSOLE/REDUNDANCY	In/Out
<b>MATING CONNECTOR:</b> ITT: KPT06J14-19P or MS3116J14-19P		

**Table 2-2. ODM/R-840 'CONSOLE/REDUNDANCY' Connector Pinout**

Pin	Name
A	SERIAL REDUNDANCY RX
B	GND
C	RX RS232
D	MUTE IN CLOCK
E	MANUAL RESET
F	ONLINE
G	GND
H	REDUNDANCY FAULT CLOCK
J	RX FAULT N/C
K	RX FAULT N/O
L	REDUNDANCY FAULT DATA
M	TX RS 232
N	GND
P	REDUNDANCY TX ENABLE
R	RX FAULT COMMON
S	+12VDC
T	AGC
U	GND
V	SERIAL REDUNDANCY TX

### 2.2.3.3 ODMR-840B Board Set 'CONSOLE/REDUNDANCY' Header

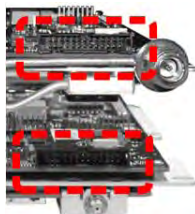

Connector Type / Part No.	Name	Direction
26-pin header, .100" spacing CEFD P/N CN/HED13MDR02 (3M N2526-5002RB)	CONSOLE/REDUNDANCY	In/Out
<b>MATING CONNECTOR:</b> Adam Technologies FCS-26-SG		

**Table 2-3. ODMR-840B 'CONSOLE/REDUNDANCY' Header Pinout**

Pin	Name
JP5-1	GND
JP5-2	N/C
JP5-3	GND
JP5-4	N/C
JP5-5	SERIAL REDUNDANCY RX
JP5-6	N/C
JP5-7	RX RS232
JP5-8	GND
JP5-9	GND
JP5-10	MUTE IN CLOCK
JP5-11	RX FAULT N/O
JP5-12	REDUNDANCY FAULT DATA
JP5-13	TX RS 232
JP5-14	REDUNDANCY FAULT CLOCK
JP5-15	RX FAULT N/C
JP5-16	ONLINE
JP5-17	AGC
JP5-18	GND
JP5-19	SERIAL REDUNDANCY TX
JP5-20	+12VDC
JP5-21	REDUNDANCY TX ENABLE
JP5-22	RX FAULT COMMON
JP5-23	GND
JP5-24	GND
JP5-25	N/C
JP5-26	N/C

## 2.3 ODM-840 Fusing, Grounding, and Power Connections

### 2.3.1 Fusing

Fuses are not user serviceable for the ODM-840:

- The ODM/R-840 features solid-state fuses for main input power.
- The ODM-840 additionally uses solid-state fuses for the installed heater (Extended Temperature) hardware options and for BUC power.
- Fusing is not provided on the ODMR-840B Board Set. You must provide your own fusing.

### 2.3.2 Grounding



**CAUTION – CONNECT THE UNIT TO A POWER SYSTEM THAT HAS SEPARATE GROUND, LINE AND NEUTRAL CONDUCTORS. DO NOT CONNECT THE UNIT WITHOUT A DIRECT CONNECTION TO GROUND.**



**The AC power interface provides the safety ground.**

The ODM/R-840 uses a #10-32 stud for connecting a common chassis ground among equipment. Grounding for the ODMR-840B Board Set is accomplished by bolt-down of the Board Set using the Board Set's available mounting slots.

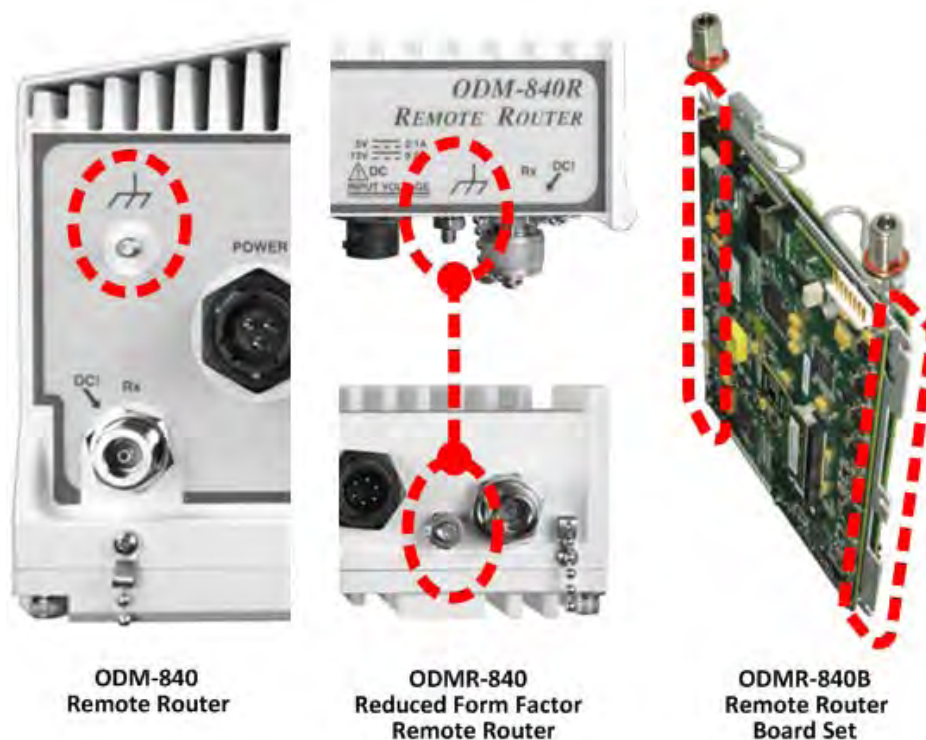

**Figure 2-6. ODM-840 Chassis Ground Interface**

## 2.3.3 Power Connections

---

### 2.3.3.1 ODM-840 Alternating Current (AC) Power Interface



This interface is **standard** on the ODM-840.

**Mating Connector:** CEFD P/N CN/MS-STPG03F02 (ITT Cannon KPT06B-12-35).

**Table 2-4. AC Power Pin Assignments**

Pin	Description
A	LINE (L1)
B	NEUTRAL (L2)
C	GND

---

### 2.3.3.2 Direct Current (DC) Power Interfaces

#### 2.3.3.2.1 ODM/R-840 Direct Current (DC) Power Interface



This power interface is **standard** on the ODMR-840. It is **optional** on the ODM-840.

**Mating Connector:** CEFD P/N CN/STPG04F01 (Amphenol PT06E-12-4S(SR) or Glenair PT06E-12-4-SSR-F7).

**Table 2-5. ODM/R-840 DC Power Pin Assignments**

Pin	Description
A	V+
B	GND
C	V-
D	NO CONNECT

### 2.3.3.2.2 ODMR-840B Board Set Direct Current (DC) Power Interfaces

Figure 2-7 shows the configuration provided for applying Direct Current (DC) power to the ODMR-840B Board Set. Connector pinouts are provided in Table 2-6. Note the following:

- An 8-pin header is provided on the top surface of the Board Set for connection of Discrete DC Power.
- A two-pin header is provided on the bottom surface of the Board Set for connection of Integrated DC Power.

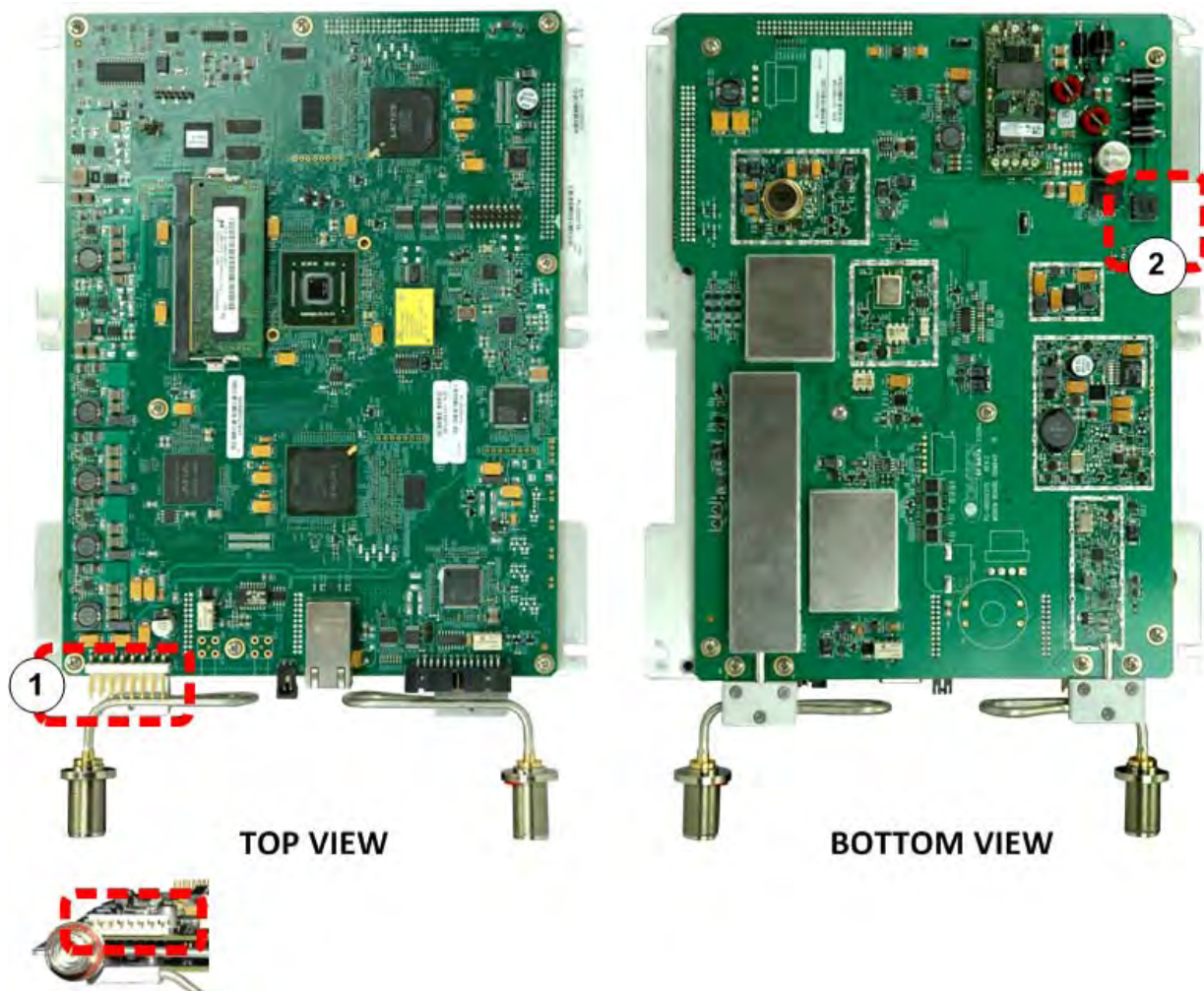

Item	CEFD P/N	Description	Manufacturer P/N	Mating Connector (Manufacturer P/N)
1	CN-0020615	Discrete Power 8-pin Header	TE Connectivity 3-641207-8	TE Connectivity 640250-8
2	CN-0000392	'J2' Integrated Power 2-pin Header	Molex 43650-0202	Molex 43645-0200

Figure 2-7. ODMR-840B Board Set DC Power Interfaces



**Table 2-6. ODMR-840B DC Power Pin Assignments**

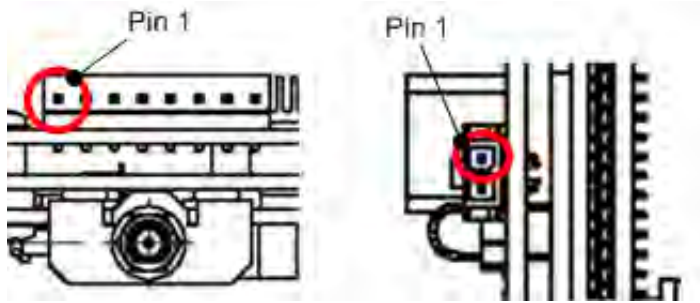

Discrete Power Connector (8-pin header)	
Pin	Description
1	+12V
2	+5V
3	+5V
4	GND
5	GND
6	N/C
7	N/C
8	N/C

'J2' Integrated Power Connector (2-pin Header)	
Pin	Description
1	V+
2	V-



# Chapter 3. INSTALLATION



**UNLESS OTHERWISE NOTED** – This chapter collectively refers to the Comtech EF Data Advanced VSAT Series ODM-840 Remote Router, ODMR-840 Reduced Form Factor Remote Router, and ODMR-840B Remote Router Board Set as the ODM-840.

---

## 3.1 Unpack and Inspect the Shipment

The ODM-840 Remote Router and its optional Installation and Operation Manual (otherwise available online at <http://www.comtechefdata.com>) were packaged and shipped in a reusable cardboard carton containing protective foam spacing.



**CAUTION – THIS EQUIPMENT CONTAINS PARTS AND ASSEMBLIES SENSITIVE TO DAMAGE BY ELECTROSTATIC DISCHARGE (ESD). USE ESD PRECAUTIONARY PROCEDURES WHEN HANDLING THE EQUIPMENT.**



**Once opened, inspect the shipment:**

Step	Task
1	Keep all shipping materials.
2	Check the packing list to make sure the shipment is complete.
3	Inspect the equipment for damage. If damage exists, immediately contact the carrier and Comtech EF Data to submit a damage report.
4	Read the manual.

---

## 3.2 Prepare for ODM-840 Standalone Installation

The ODM-840 Remote Router is constructed as a fully contained, weatherproof chassis intended for field installations.

The term “standalone” as used in this chapter refers to the mounting of a single ODM-840 Remote Router or a single ODMR-840 Reduced Form Factor Remote Router to a satellite antenna support pole. The equipment can also be freestanding if desired. Cables are then connected for non-redundant operation.

The ODMR-840B Board Set must be installed into a user-supplied weatherproof enclosure. Detailed installation instructions are therefore not provided in this chapter.

Comtech EF Data recommends that, at a minimum, you use the following tools to install any ODM-840 Standalone configuration:

- Adjustable wrench
- English unit box or socket wrenches (the kits use hex nuts and hex head bolts)
- Medium Phillips™ screwdriver (the kits use Phillips-head screws)
- Tin snips

---

## 3.3 ODM-840 Standalone Installation

### 3.3.1 Overview

**Figure 3-1** shows an example of a temporary ODM-840 Unistrut field installation setup. Use of Unistrut P3300-series channels in all configurations permits you to mount the unit with CEFD kit-provided hardware. For assembly onto a satellite antenna support pole, use the designated CEFD Pole Mounting Kit.



**Assemble the Unistrut segment(s) that are provided in a specific CEFD ODM-840 Unit Mounting Kit to the support pole at this initial stage of assembly; install the remaining kit components after you mount the unit itself to the support pole.**



**Figure 3-1. ODM-840 Temporary Field Installation Example**

**Figure 3-2** and the chapter sections that follow show the installation of the kits required for standalone installation and operation:

- **Pole Mounting Kits:**

- **KT-0000262 Pole Mounting Kit** – Assemble this kit to the satellite antenna support pole, and then install either the ODM-840 or the ODMR-840 chassis kit KT-0000227 Unistruts.

See **Sect. 3.3.2** for complete kit assembly instructions.

- **Unit Mounting Kits:**

- **KT-0000227 ODM-840 Standalone Mounting Kit** – Use this kit to mount a standalone ODM-840 Remote Router to the pole-mounted Unistruts.

See **Sect. 3.3.3** for complete kit assembly instructions.

- **Cabling Kits:**

- **KT-0000263 (AC) or KT-0020566 (DC) ODM-840 Standalone Cabling and Connections Kit** – These kits provide the chassis-to-user power cable, and the weatherproof connector components required to fabricate an Ethernet management/traffic cable.

See **Sect. 3.3.4.1** for further information.

- **KT-00020567 ODMR-840 Standalone Cabling and Connections Kit** – This kit provides the power cable set (ODMR-840 to user) and the weatherproof connector components required to fabricate an Ethernet management/traffic cable.

See **Sect. 3.3.4.2** for further information.

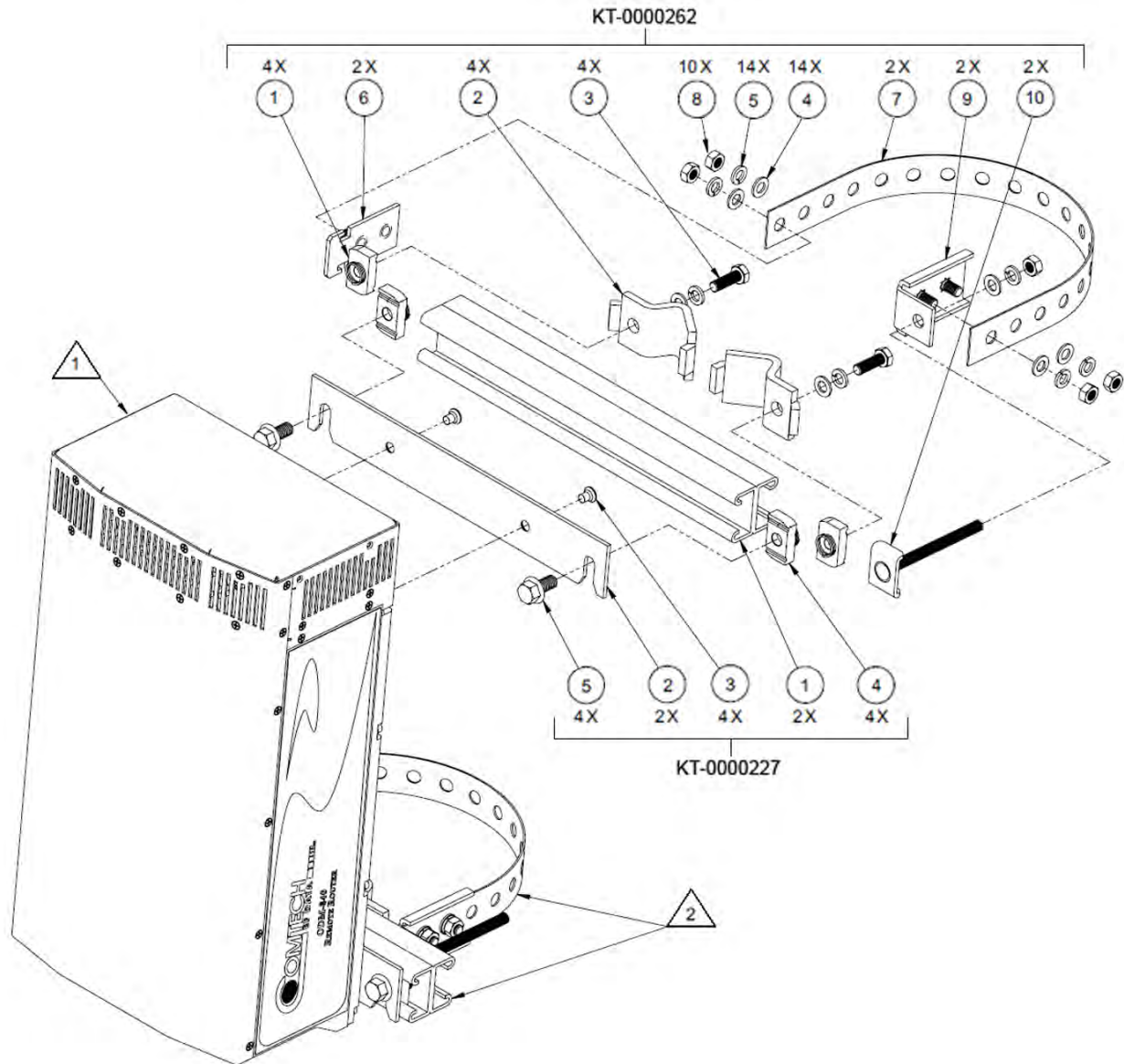
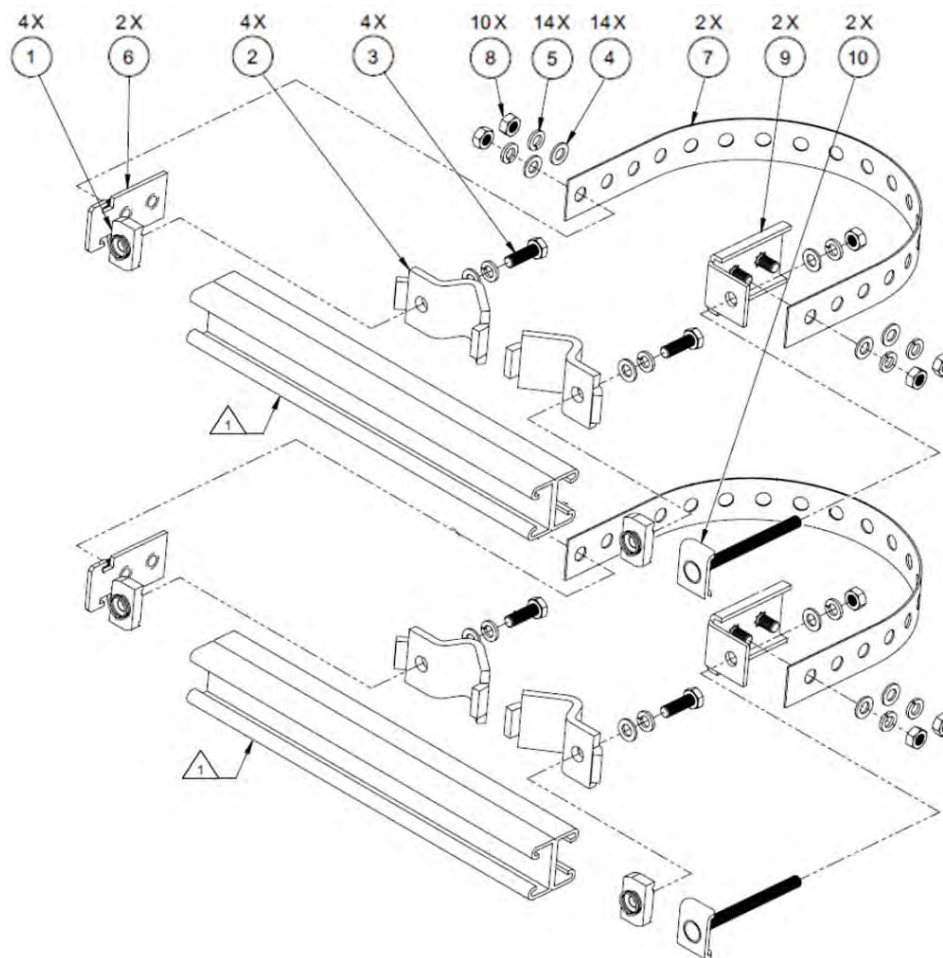

 **Figure Notes:**

- 1 The ODM-840 Remote Router is furnished separately. It is shown for reference only.
- 2 The KT-0000262 and KT-0000227 kits are assembled separately.

**Figure 3-2. ODM-840 Remote Router – Standalone Installation**

### 3.3.2 Install the ODM-840 KT-0000262 Pole Mounting Kit (with Unit Mounting Kit Unistruts)



**Figure Note:**

- 1 The Unistruts (CEFD P/N FP-0001131) are part of CEFD Kit KT-0000227.

KT-0000262 POLE MOUNTING KIT			
ITEM	QTY	CEFD PART NO.	DESCRIPTION
1	4	HW/M8SPRINGNUT	SPRING NUT, M8
2	4	HW/BLK-PIPE2-8	PIPE BLOCK
3	4	HW/M8X1.25X25HEXSS	HEX HEAD BOLT, M8, 25MM LG
4	14	HW/M8FLATSS	FLAT WASHER, M8
5	14	HW/M8LOCKSS	LOCK WASHER, M8
6	2	FP/BR0069	FLOATING STRAP BRACKET
7	2	FP/BR0071	PIPE STRAP (TRIM TO REQUIRED LENGTH)
8	10	HW/M8X1.25HEXNUTSS	HEX NUT, M8 X 16MM LG
9	2	FP/BR0070	FIXED STRAP BRACKET
10	2	FP/BR0072	STRAP TENSIONER BOLT

**Figure 3-3. ODM-840 Pole Mounting Kit (CEFD P/N KT-0000262)**

<b>KIT KT-0000262 ASSEMBLY INSTRUCTIONS</b> (see Figure 3-3 and Figure 3-5 to identify all of the assembly items used with this procedure)	
<b>Step</b>	<b>Task</b>
<b>1</b>	Place an ODM-840 Unistrut (Item 1 from CEFD Kit KT-0000227) on a flat surface. <b>(The remainder of this procedure uses the components provided in CEFD Kit KT-0000262.)</b>
<b>2</b>	Slide two Spring Nuts (Item 1) into the Unistrut channel. Make sure that the springs face the inner wall of the channel.
<b>3</b>	For each Spring Nut, use one each of the M8 Hex Bolt (Item 3), Flat Washer (Item 4), and Lock Washer (Item 5) to assemble a Pipe Block (Item 2) loosely to the installed Spring Nut. <i>Do not tighten the bolts at this time.</i>
<b>4</b>	Position the semi-assembled Unistrut and Pipe Blocks against the satellite antenna support pole and then slide the Pipe Blocks until they contact either side of the support pole. Make sure the Pipe Blocks are centered within the Unistrut, and then tighten the mounting hardware.
<b>5</b>	Slide the Floating Strap Bracket (Item 6) into the Unistrut channel. Make sure that the bracket studs face outward.
<b>6</b>	Use the Floating Strap Bracket with two each of the M8 Flat Washers, Lock Washers, and Hex Nuts (Item 8) to secure the Pipe Strap (Item 7).
<b>7</b>	a) Hold the kit subassembly in place against the support pole and slide the Fixed Strap Bracket (Item 9) into the Unistrut channel until it abuts the adjacent Pipe Block.  b) Wrap the Pipe Strap around the support pole, and then fit the strap onto the Fixed Strap Bracket studs as snugly as possible. Score or otherwise mark a trim line on the Pipe Strap, and then use the tin snips to trim the Pipe Strap as needed.
<b>8</b>	a) Remove the Fixed Strap Bracket from the Unistrut channel, and assemble the Strap Tensioner Bolt (Item 10) to the Fixed Strap Bracket (the bolt head will abut the inner wall of the channel upon assembly).  b) Slide this subassembly back into the Unistrut channel until it abuts the adjacent Pipe Block.
<b>9</b>	Use the Fixed Strap Bracket with two each of the M8 Hex Nuts, Flat Washers, and Lock Washers to secure the Pipe Strap.
<b>10</b>	Use the Strap Tensioner Bolt with one each of the M8 Flat Washer, Lock Washer, and Hex Nut to secure the Fixed Strap Bracket in place. Tighten as needed. <b>Figure 3-4</b> shows correctly installed Pole Mounting Kit assemblies. A properly trimmed Pipe Strap is shown in the side view.
<b>11</b>	Repeat Steps 1 through 10 to assemble and install the second half of the Pole Mounting Kit. For proper mounting of the ODM-840 Remote Router, both assemblies must be spaced <b>11.31"</b> apart. The front view of a correctly installed Pole Mounting Kit is shown in <b>Figure 3-4</b> .

**Proceed to Sect. 3.3.3 to install ODM-840 Remote Router.**



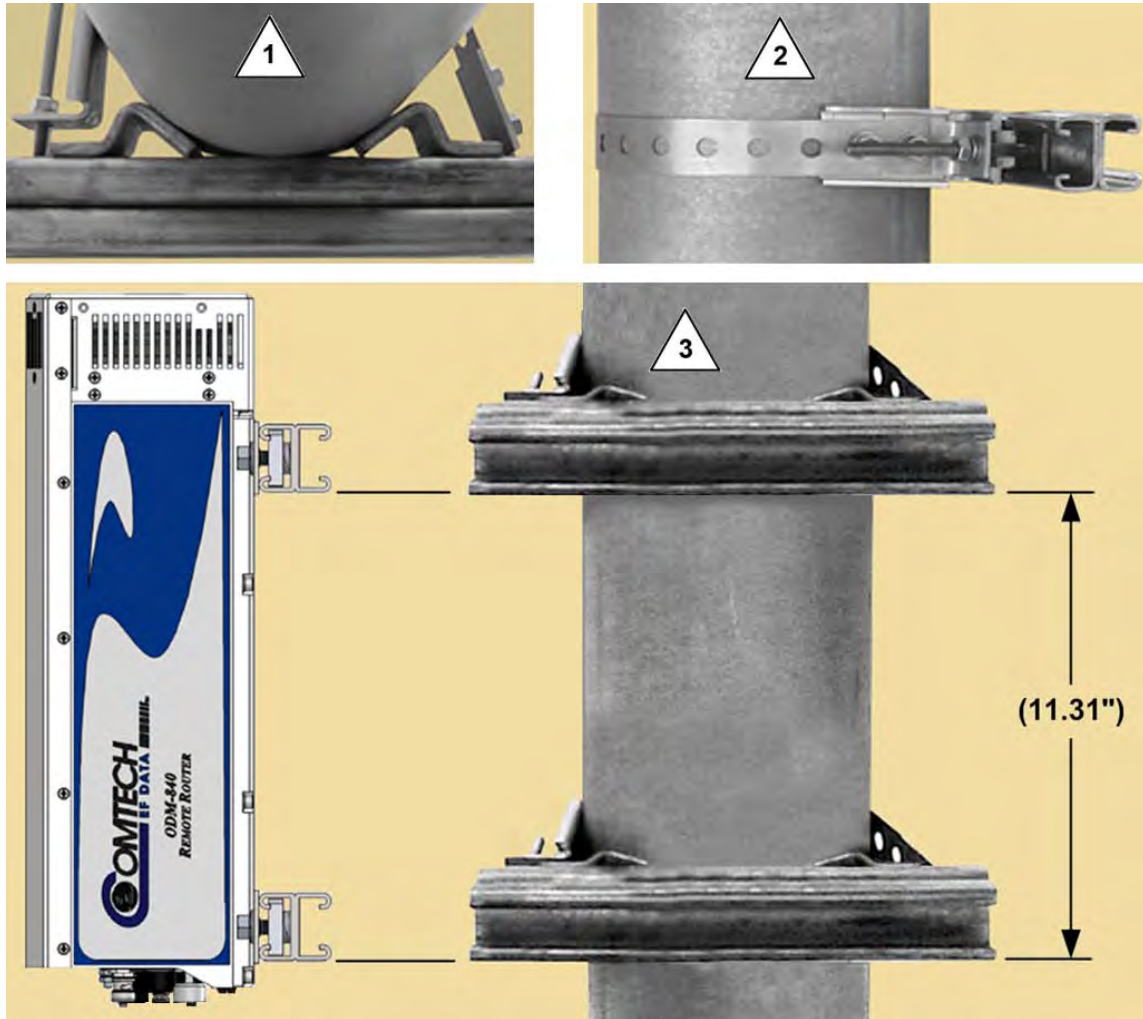
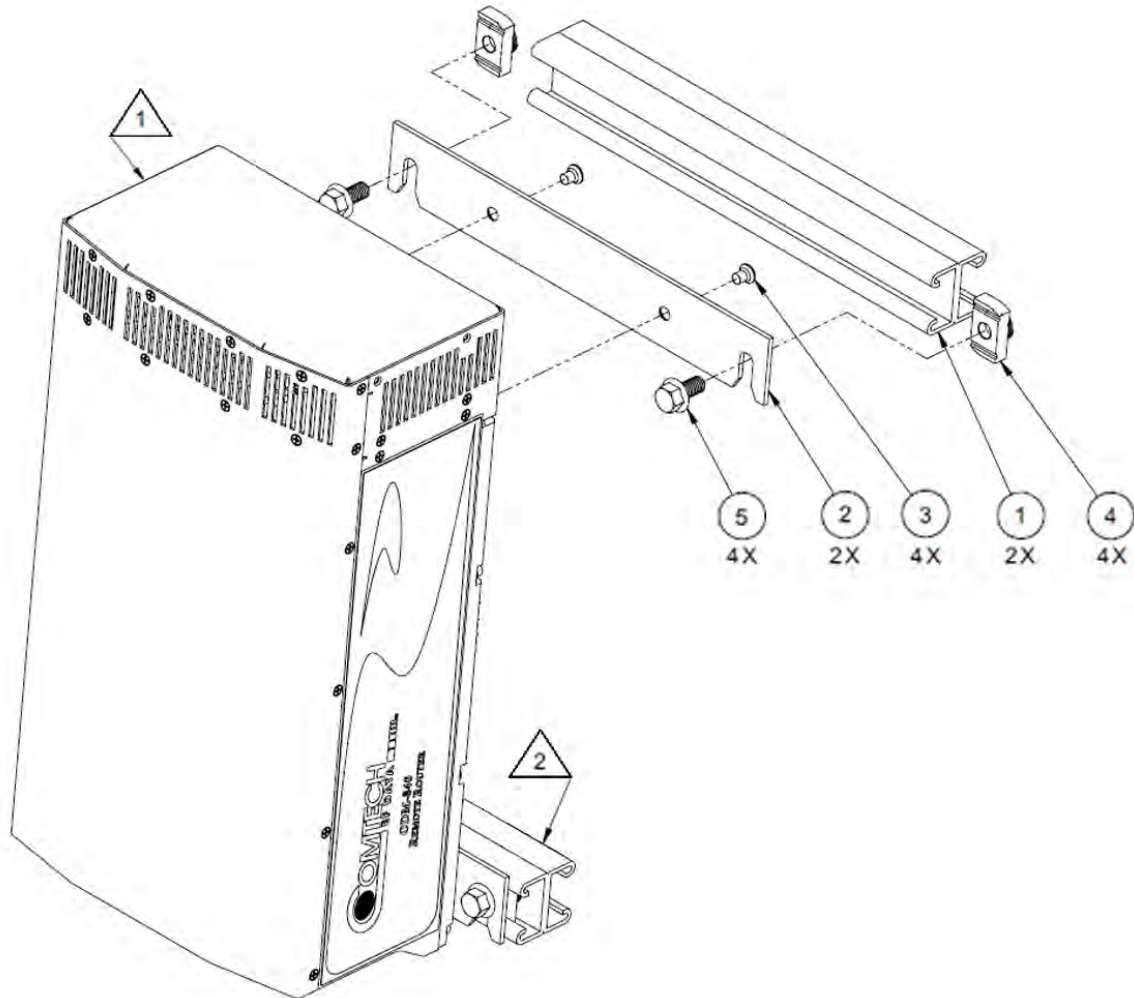

**Figure Notes:**

- 1 Typical Pole Mounting Kit assembly with Unistrut – top view.
- 2 Typical Pole Mounting Kit assembly with Unistrut – side view. Be sure to trim the Pipe Strap (Item 7) as instructed in Step 7(b).
- 3 Typical Pole Mounting Kit assemblies with Unistruts – front view:
  - Be sure to space the assemblies as shown.
  - This figure shows an ODM-840 installation. It is also typical for an ODMR-840 chassis installation.
  - See **Sect. 3.3.3** for the ODM-840 Unit Mounting Kit assembly instructions.

**Figure 3-4. ODM-840 Pole and Unit Mounting Kits – Assembly and Spacing**

### 3.3.3 Install the ODM-840 KT-0000227 Mounting Kit



**Figure Notes:**

- 1 The ODM-840 is purchased separately. It is shown for reference only.
- 2 The Unistruts (Item 1, CEFD P/N FP-0001131) are pre-assembled to the satellite antenna support pole. See **Sect. 3.3.2** for the assembly instructions.

KT-0000227 ODM-840 STANDALONE MOUNTING KIT			
ITEM	QTY	CEFD PART NO.	DESCRIPTION
1	2	FP-0001131	UNISTRUT, DUAL-CHANNEL
2	2	FP-0001130	UNIT MOUNTING BRACKET
3	4	HW-0000385	82° FLAT HEAD SCREW, 1/4-20 X 3/8 LG, PHILLIPS HEAD, SS
4	4	HW/3/8SPRINGNUT	SPRING NUT, 3/8-16, SHORT SPRING, SS (P3300)
5	4	HW-0000070	FLANGED HEX HEAD SCREW, 3/8-16 X 7/8 LG, SS

**Figure 3-5. ODM-840 Standalone Unit Mounting Kit (CEFD P/N KT-0000262)**

<b>KIT KT-0000227 ASSEMBLY INSTRUCTIONS</b> (see Figure 3-3 and Figure 3-5 to identify all of the assembly items used with this procedure)	
<b>Step</b>	<b>Task</b>
<b>1</b>	Make sure that both Unistruts (Item 1) have been pre-assembled to the satellite antenna support pole. See <b>Sect. 3.3.2</b> for the assembly instructions.
<b>2</b>	<b>As shown in Figure 3-5</b> – Use the Flat Head Screws (Item 3) to assemble both Unit Mounting Brackets (Item 2) to the ODM-840 unit (furnished separately). Make sure to install the brackets so that their mounting slots face <i>downward</i> .
<b>3</b>	Slide two spring nuts (Item 4) into each pole-mounted Unistrut channel. Make sure that the springs face the inner wall of the channels.
<b>4</b>	<b>As shown in Figure 3-6</b> – Typical for each spring nut: Use a Flanged Hex Head Screw (Item 5) to assemble each screw loosely to its installed spring nut. <i>Do not tighten the screws at this time – maintain a gap of around 0.20" between each screw flange and the Unistrut channel mounting face.</i>  <b>As shown in Figure 3-6</b> – Make sure that each set of loosely assembled nuts and screws are positioned approximately <b>10.5"</b> apart and centered within the Unistruts to the support pole.
<b>5</b>	<b>As shown in Figure 3-7</b> – Install the ODM-840 unit to the Unistruts: Position the ODM-840 assembly against the Unistrut channel top flanges just above the protruding Flanged Hex Head Screws. Use the Unit Mounting Bracket slots to carefully guide, and then drop, the ODM-840 assembly into position.
<b>6</b>	Tighten all four of the Flanged Hex Head Screws.
<i>The installed unit is now ready for cabling. See Sect. 3.3.4 for details.</i>	

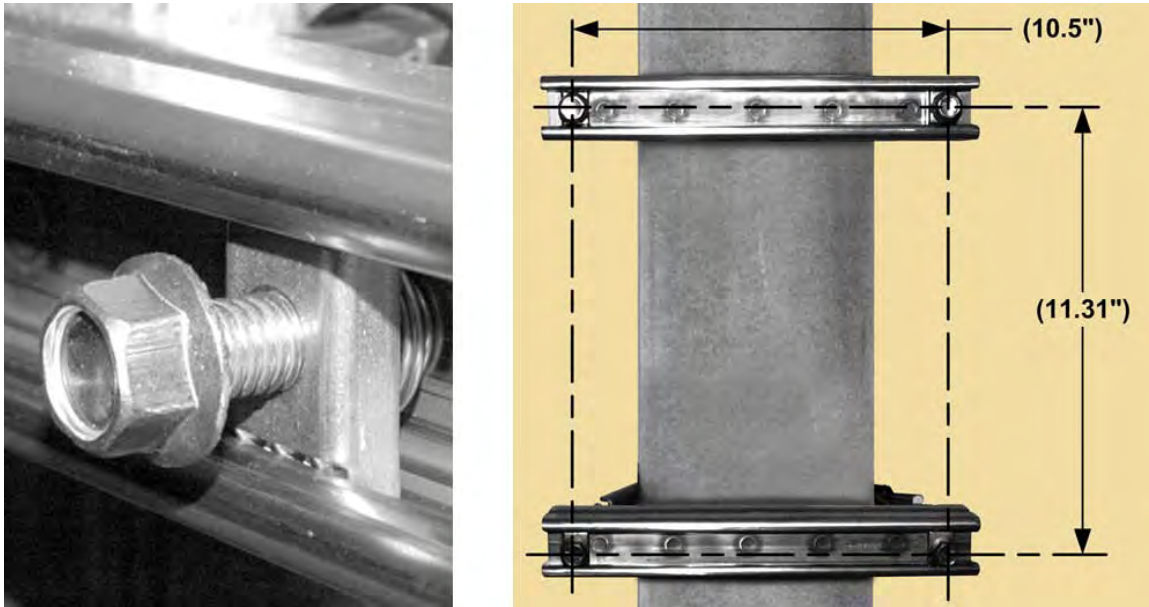

**Figure 3-6. ODM-840 Unit Mounting – Spring Nut and Screw Installation and Spacing**



(Figure Note: The satellite antenna support pole is not shown for clarity.)

**Figure 3-7. ODM-840 Unit Mounting – Installation onto Unistruts**

### 3.3.4 ODM-840 Cabling



**Signal attenuation and possible loss of signal can occur in the presence of moisture. You must therefore seal all cable connectors used in outdoor applications to avoid leakage. This applies particularly for Type 'N' and 'BNC' connectors, where moisture can seep into both the junctions at the plug end of the connector (between the fixed and movable parts), and where the cable connects to the connector.**

**You must seal all cable junctions, including military style (MS) connectors, with a tape such as 3M Type 23 Scotch Self-Amalgamating Tape or its equivalent.**

Typical for all applications, note the following:

- 1) Your site installation determines your cabling lengths. As such, you are required to fabricate all service cables.
- 2) Exercise care with cable installation. Use the most direct route to install your cabling. Avoid all sharp bends.
- 3) Secure all routed cables with clamps and ties.

Cabling Kits KT-0000263 and KT-0020566 are provided for the power and Ethernet connections for the ODM-840. Cables Kit KT-0020567 is provided for the power and Ethernet connections for the ODMR-840.

### 3.3.4.1 ODM-840 Cabling

Figure 3-8 summarizes the cabling requirements for an ODM-840 Standalone Installation.

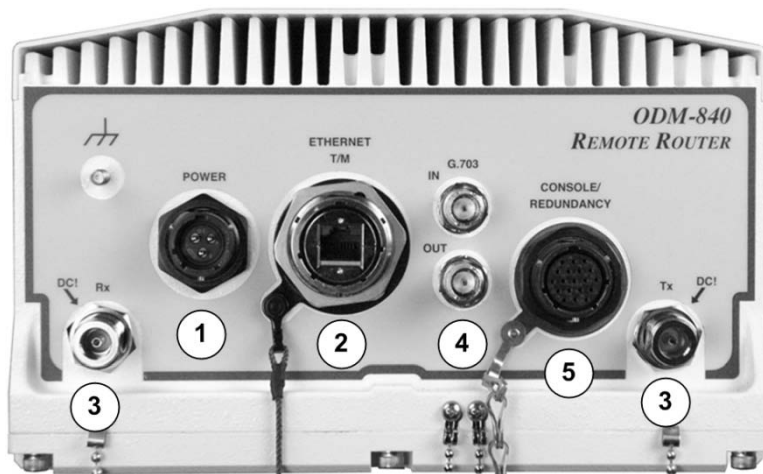

KT-0000263 ODM-840 AC CABLE KIT			
Item	Qty	CEFD Part No.	Description
1	1	CA-0000435	AC POWER CORD, ODM-840 TO USER, 70"
2	1	CN/RJF-6B	RJ-45 WEATHERPROOF BAYONET COUPLING-STYLE CIRCULAR CONNECTOR (FOR USE WITH 8-PIN ETHERNET CABLE PROVIDED BY USER)

KT-0020566 ODM-840 DC CABLE KIT			
Item	Qty	CEFD Part No.	Description
1	1	CA-0020696	POWER CABLE, DC POWER INPUT FROM USER TO ODM-840, 25 FT
2	1	CN/RJF-6B	RJ-45 WEATHERPROOF BAYONET COUPLING-STYLE CIRCULAR CONNECTOR (FOR USE WITH 8-PIN ETHERNET CABLE PROVIDED BY USER)

USER-PROVIDED CABLING			
Item	Qty	CEFD Part No.	Description
3	2	ROHS-COMPLIANT COAX CABLE WITH TYPE 'N' MALE CABLE ENDS	L-BAND RX AND TX SIGNAL CONNECTIONS
4	2	ROHS-COMPLIANT COAX CABLE WITH TYPE 'BNC' MALE CABLE ENDS	G.703 E1 INPUT AND OUTPUT CONNECTIONS

OPTIONAL UTILITY CABLING			
Item	Qty	CEFD Part No.	Description
5	1	CA-0000722	RS-232 SERIAL COMMUNICATION CABLE



The length-specific AC Power Cord (CEFD P/N CA-0000435) and the optional Serial Communication Cable (CEFD P/N CA-0000722) are intended for configuration and testing of the unit prior to field installation.

Figure 3-8. ODM-840 Cabling Connections

### 3.3.4.2 ODMR-840 Cabling

Figure 3-9 summarizes the cabling requirements for an ODMR-840 Standalone Installation.

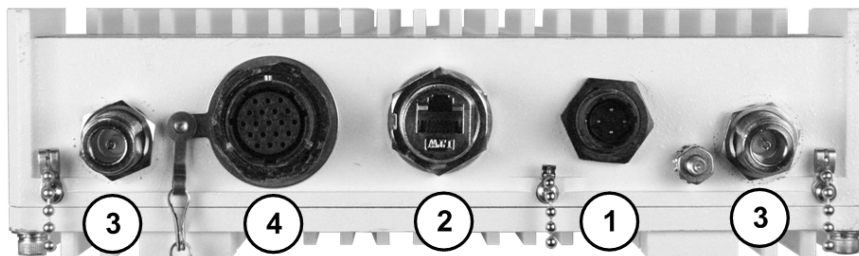

KT-0020567 DC CABLE KIT			
Item	Qty	CEFD Part No.	Description
1	1	CA-0020696	DC Power Cable – DC Power Input from user to ODMR-840 – 25 ft
2	1	CN-0020514	RJ-45 Weatherproof Threaded Coupling-style Connector (for use with 8-PIN Ethernet Cable provided by user)
	1	CN/HED87522-8002	RJ-45 8-pin Male Connector (Plug)

USER-PROVIDED CABLING			
Item	Qty	CEFD Part No.	Description
3	2	RoHS-compliant Coax Cable with Type 'N' Male Cable Ends	L-Band Rx and Tx Signal connections

OPTIONAL UTILITY CABLING			
Item	Qty	CEFD Part No.	Description
4	1	CA-0000722	RS-232 Serial Communication Cable



**Use the optional Serial Communication Cable (CEFD P/N CA-0000722) to configure and test the unit prior to field installation.**

**Figure 3-9. ODMR-840 Cabling Connections**

### 3.3.4.3 ODMR-840B Cabling



All cabling for the ODMR-840B Board Set depends on your custom enclosure and your Advanced VSAT system interconnection/interface configuration. To assist you in fabricating or purchasing the pertinent cabling, pinout information is provided in Chapter 2. ODMR-840/B CONNECTIONS and cross-referenced in the table provided in Figure 3-10.

Figure 3-10 summarizes the cabling requirements for an ODMR-840 Board Set, applicable only to standalone installations.

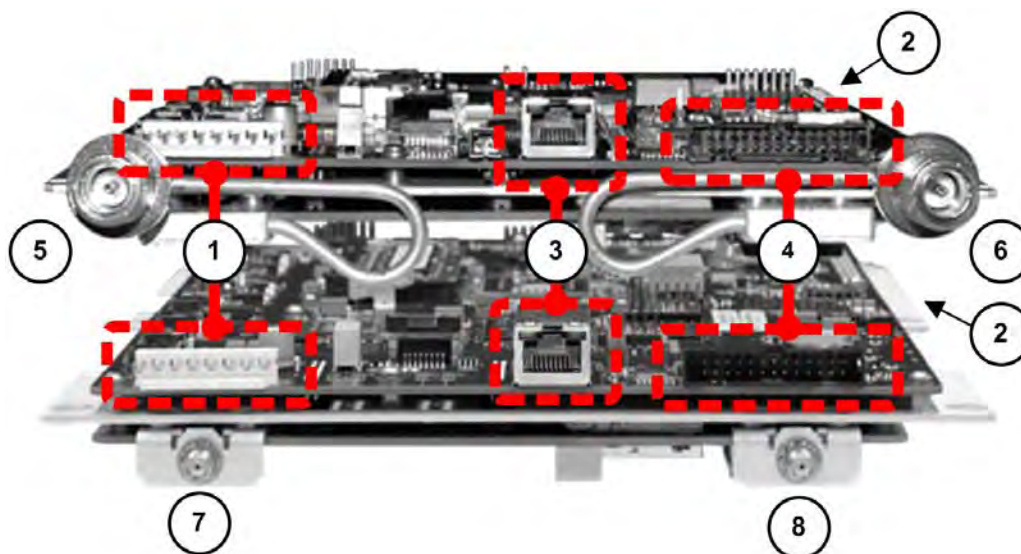

USER-PROVIDED CABLING		
Item	Cable Description	Connector Pinout Table (Chapter 2)
1	Discrete DC Power Cable – 8-pin socket connector (TE Connectivity P/N 640250-8) to user-configured DC power end interface	Table 2-6
2	Integrated DC Power Cable (on bottom surface of Board Set) – 2-pin male connector (Molex P/N 43645-0200) to user-configured DC power end interface	
3	Standard Ethernet CAT5 (8-pin) RJ-45 to RJ-45 cable	N/A
4	CONSOLE/REDUNDANCY Cable – 26-pin socket connector (Adam Technologies FCS-26-SG) to user-defined EIA-232 serial end interface	Table 2-3
5	Tx RoHS-compliant Coax Cable with Type 'N' Male Cable Ends	N/A
6	Rx RoHS-compliant Coax Cable with Type 'N' Male Cable Ends	
7	Tx RoHS-compliant Coax Cable with Type 'SMA' Male Cable Ends	
8	Rx RoHS-compliant Coax Cable with Type 'SMA' Male Cable Ends	

**Figure 3-10. ODMR-840B Cabling Connections**



### 3.3.4.4 Field-Fabricated User Cabling

#### 3.3.4.4.1 Fabricate an ODM-840 AC Power Cable

See the wire list in **Figure 3-11** to fabricate a site-specific AC power cable (for use only with ODM-840 units). Any fabricated cable must use ITT Cannon P/N KPT06B-12-35 as the P1 mating connector.

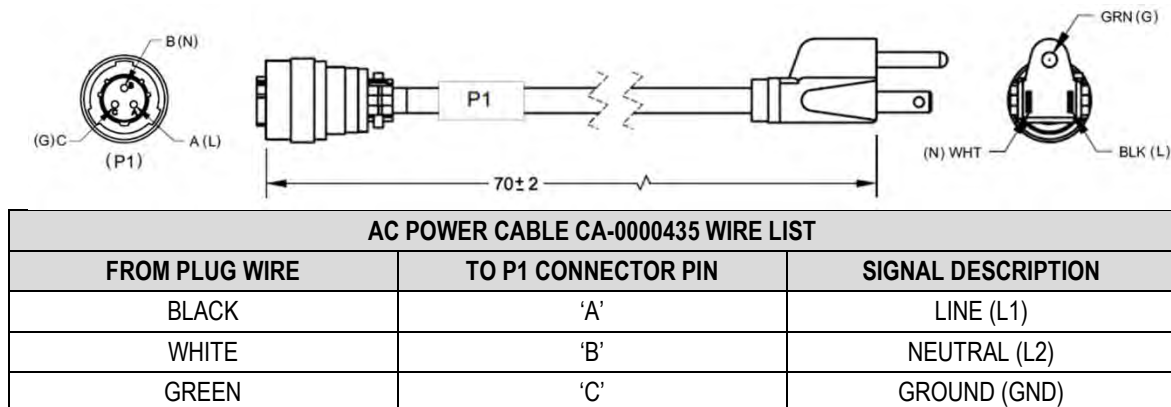

**Figure 3-11. AC Power Cord (REF CEFD P/N CA-0000435)**

#### 3.3.4.4.2 Fabricate an ODM-840 DC Power Cable

See the wire list in **Figure 3-12** to fabricate a site-specific DC power cable (for use with standard ODMR-840 or optional ODM-840 DC units). Any fabricated cable must use Amphenol PT06E-12-4S(SR) or Glenair PT06E-12-4-SSR-F7 as the J1 mating connector.

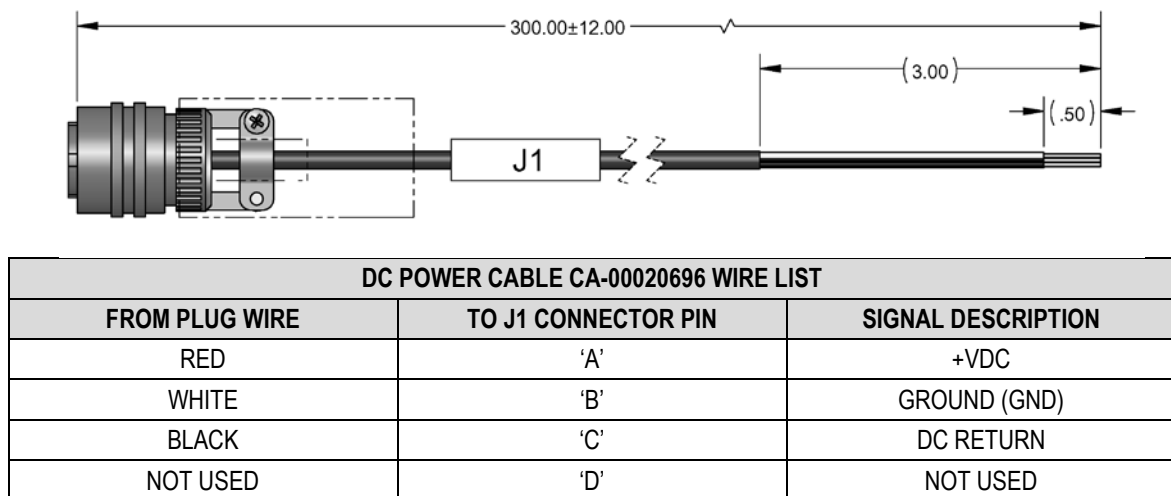

**Figure 3-12. DC Power Cord (REF CEFD P/N CA-00020696)**

### 3.3.4.4.3 Fabricate an ODMR-840B DC Power Cable

To fabricate a site-specific Discrete DC Power or Integrated DC Power Cable for use with the ODMR-840B Board Set, see **Table 2-6** in **Sect. 2.3.4.2** of **Chapter 2. ODM-840/B CONNECTIONS** for the pertinent connector pinouts. Any fabricated cable must use a TE Connectivity P/N 640250-8 (for Discrete DC Power connections) or Molex P/N 63645-0200 connector (for Integrated DC Power connections) as the mating connector.

### 3.3.4.4.4 Fabricate a Serial Communication Cable

#### 3.3.4.4.4.1 Fabricate an ODM-840 Serial Communication Cable

To fabricate a site-specific Serial Communication Cable (for use with ODM-840 or ODMR-840 units) see **Table 2-2** in **Sect. 2.2.3.2** of **Chapter 2. ODM-840/B CONNECTIONS** for the ‘**CONSOLE/REDUNDANCY**’ connector pinouts. Any fabricated cable must use an ITT Cannon P/N KPT06J14-19P (MS3116J14-19P) as the mating connector.



SERIAL COMMUNICATION CABLE WIRE LIST		
FROM	TO	SIGNAL DESCRIPTION
P1-B	J1-5	GND
P1-C	J1-3	RX EIA-232
P1-M	J1-2	TX EIA-232

**Figure 3-13. Serial Communication Cable (REF CEFD P/N CA-0000722)**

#### 3.3.4.4.4.2 Fabricate an ODMR-840B Serial Communication Cable

To fabricate a site-specific Serial Communication Cable for use with the ODMR-840B Board Set see **Table 2-3** in **Sect. 2.2.3.3** of **Chapter 2. ODM-840/B CONNECTIONS** for the ‘**CONSOLE/REDUNDANCY**’ header pinouts. Any fabricated cable must use an Adam Technologies P/N FCS-26-SG socket connector as the board-end mating connector.

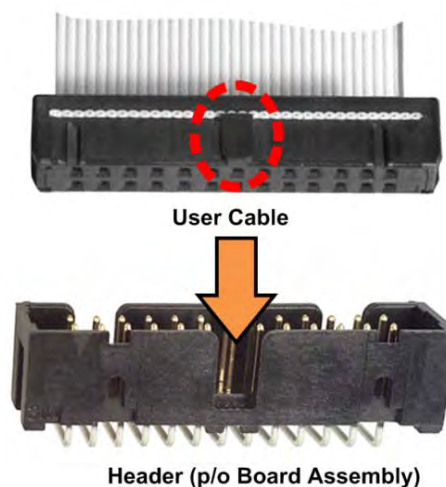

### 3.3.4.4.5 Fabricate an Ethernet Cable

#### 3.3.4.4.5.1 Fabricate an ODM-840 Ethernet Cable

To fabricate a site-specific Ethernet cable for use with the ODM-840 Remote Router, use the CN/RJF-6B connector provided in CEFD kit KT-0000263 or KT-0020566.

As per **Figure 3-14**, do these steps:

Step	Task
1	Thread the user-supplied RJ-45 cordset (Item 1) through the Item 2 components. Be sure to note the order and orientation of all components prior to final assembly of the connector.
2	Assemble the connector insulator insert halves (Item 2.4) to the RJ-45 cordset plug: <ul style="list-style-type: none"> <li>• Depress the RJ-45 cordset plug tab and slip one-half of the insulator insert onto the RJ-45 plug.</li> <li>• Assemble the other half of the insulator insert onto the RJ-45 plug.</li> <li>• Snap the insulator lock tab into place to complete the insulator assembly.</li> </ul>
3	At the front, seat the insulated RJ-45 plug assembly into the circular connector sleeve (Item 2.5) – note the sleeve’s main key orientation as shown in the figure must conform to the Amphenol ‘Code A’ orientation specification – and then thread the assembly onto the connector body (Item 2.3)
4	Use the jam nut (part of Item 2.3) to secure the circular connector sleeve and insulated plug assembly (in its correct orientation) to the connector body. <b>DO NOT OVERTIGHTEN.</b>
5	At the back, slip the compression bushing (Item 2.2) into the connector body, and then screw the end cap (Item 2.1) onto the connector body. <b>DO NOT OVERTIGHTEN.</b>

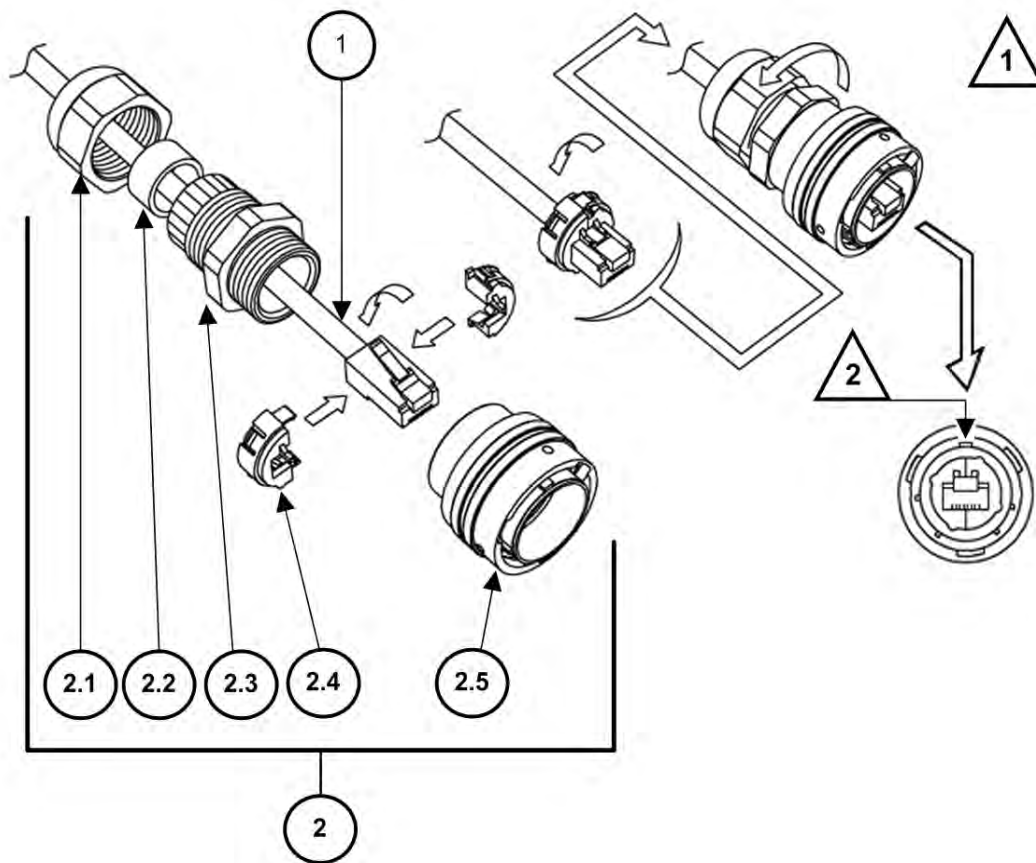

**Figure Notes (Assembly Detail Source: Amphenol Corporation)**

- 1 Cable end is shown here as assembled.
- 2 Note the positioning of the connector's main key – use 'Code A' orientation to assemble the connector to the Ethernet cable.

USER ETHERNET CABLE ASSEMBLY USING KIT KT-0000263 OR KT-0020566 COMPONENTS		
Item	CEFD Part No.	Description
1	N/A	RJ-45 8-PIN CORDSET, LENGTH A/R, PROVIDED BY USER
2	CN/RJF-6B	(AMPHENOL CORP. P/N RJF-6B) RJ-45 WEATHERPROOF BAYONET COUPLING-STYLE CIRCULAR CONNECTOR, CONSISTING OF FOLLOWING COMPONENTS:
2.1	N/A	END CAP
2.2	N/A	COMPRESSION BUSHING
2.3	N/A	CONNECTOR BODY WITH JAM NUT
2.4	N/A	PLUG INSULATOR (RIGHT/LEFT HALVES)
2.5	N/A	CIRCULAR CONNECTOR SLEEVE

**Figure 3-14. ODM-840 Ethernet User Cable Assembly**

### 3.3.4.4.5.2 Fabricate an ODMR-840 Ethernet Cable

To fabricate a site-specific Ethernet cable for use with the ODMR-840 Reduced Form Factor Remote router, use the CN-0020514 and CN/HED87522-8002 connectors provided in CEFD kit KT-0020567.

As per **Figure 3-15**, do these steps:

Step	Task
1	Peel off the backing from the connector gasket (Item 2.5) and affix the gasket to the front face of the connector body (Item 2.4). Be sure to align the gasket cutout to the opening on the connector body.
2	Thread the RJ-45 cable (Item 1, provided by user) through the Item 2 components as shown. Be sure to note the order and orientation of all components prior to final assembly of the RJ-45 cordset.
3	Install the RJ-45 plug (Item 3) onto the user-supplied cable. Be sure to use the proper tooling when assembling the cordset.
4	Assemble all components: <ul style="list-style-type: none"><li>• At the front, depress the RJ-45 plug tab and seat the connector into its mating socket in the connector body.</li><li>• At the back, slip the compression bushing (Item 2.2) into the connector body.</li><li>• Screw the end cap (Item 2.1) onto the connector body. <b>DO NOT OVERTIGHTEN.</b></li></ul>

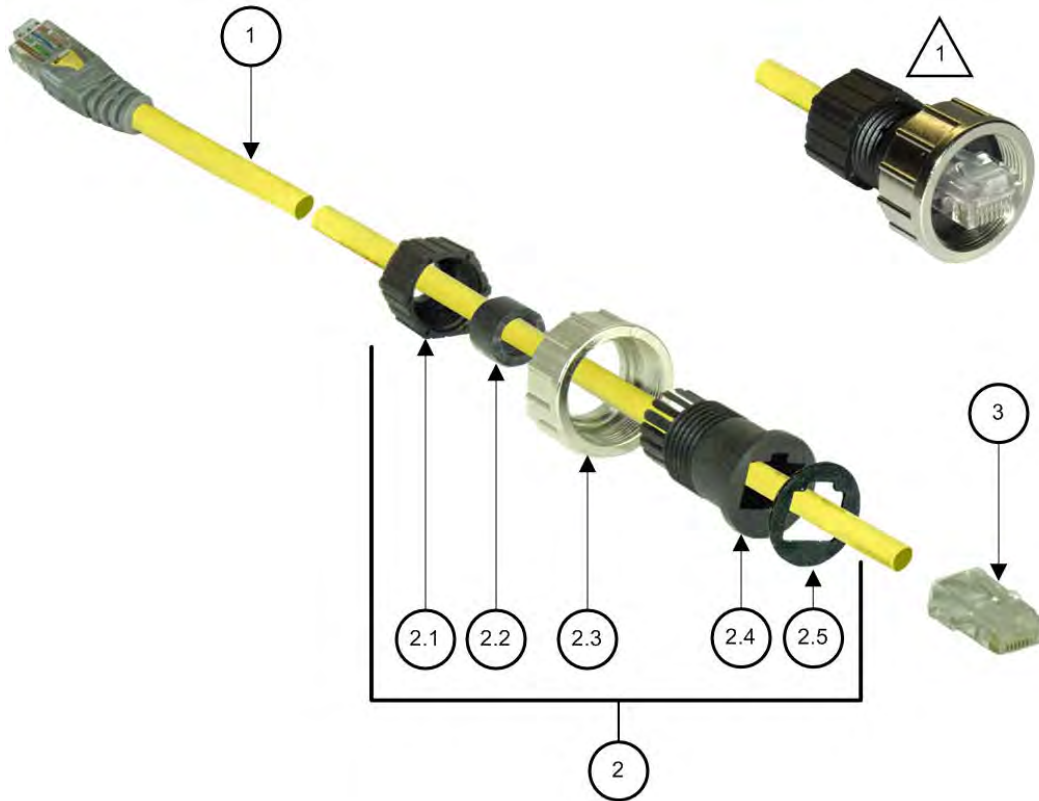

**Figure Notes:**

- 1 Cable end is shown here as assembled.

USER ETHERNET CABLE ASSEMBLY USING KIT KT-0020567 COMPONENTS			
Item	Qty	CEFD Part No.	Description
1	1	N/A	RJ-45 8-PIN CABLE, LENGTH A/R, PROVIDED BY USER
2	1	CN-0020514	(LTW CORP. P/N LTWRJ-00BMMA-SL7006) RJ-45 WEATHERPROOF THREADED COUPLING-STYLE CONNECTOR, CONSISTING OF THE FOLLOWING COMPONENTS:
2.1	1	N/A	END CAP
2.2	1	N/A	COMPRESSION BUSHING
2.3	1	N/A	CONNECTOR NUT
2.4	1	N/A	CONNECTOR BODY
2.5	1	N/A	GASKET
3	1	CN/HED87522-8002	RJ-45 8-PIN CONNECTOR (PLUG)

**Figure 3-15. ODMR-840 Ethernet User Cable Assembly**

# Chapter 4. UPDATING FIRMWARE



**UNLESS OTHERWISE NOTED** – This chapter collectively refers to the Comtech EF Data Advanced VSAT Series ODM-840 Remote Router, ODMR-840 Reduced Form Factor Remote Router, and ODMR-840B Remote Router Board Set as the ODM-840.

---

## 4.1 Firmware Update Overview



- 1) **Make sure to operate the ODM-840 with its latest available firmware.**
- 2) **Contact Comtech EF Data Product Support for instructions on completing any serial-based upgrade tasks for your specific ODMR-840 Board Set installation.**

Comtech EF Data ships the ODM-840 with its latest version of operating firmware. If you require a firmware update, you must contact Comtech EF Data Product Support.

You may apply firmware updates to an in-service ODM-840 without having to access the unit enclosure. To update the firmware:

- Obtain the firmware update archive file from Comtech EF Data Product Support.
- Establish the proper communications link for acquiring the firmware update archive files by directly connecting a user-supplied Microsoft Windows-based PC to the 10/100/1000 BaseT Gigabit Ethernet RJ-45 Traffic and Management Interface Port.
- Use Windows Command-line to transfer, via File Transfer Protocol (FTP), the extracted firmware files from the User PC to the ODM-840 standby firmware image.
- Use the ODM-840 HTTP (Web Server) Interface to configure the modem to operate using the updated firmware image.

## 4.2 Getting Started: Prepare for the Firmware Download

Do these steps:

1. Identify the assigned Management/Traffic IP Address, and the firmware number/revision letter/version number.

### *User-supplied items needed:*

- A Microsoft Windows-based PC, equipped with available serial and Ethernet ports; a compatible Web browser (e.g., Internet Explorer); and a terminal emulator program (e.g., Tera Term or HyperTerminal).
  - A 19-pin-to-9-pin serial adapter cable to connect the PC to the ODM-840.
  - The available outdoor Ethernet cable to connect the PC to the ODM-840 – either directly, or with a user-supplied hub or switch.
- a) Use the serial adapter cable to connect the ODM-840 'CONSOLE/REDUNDANCY' connection to a serial port on the user PC.

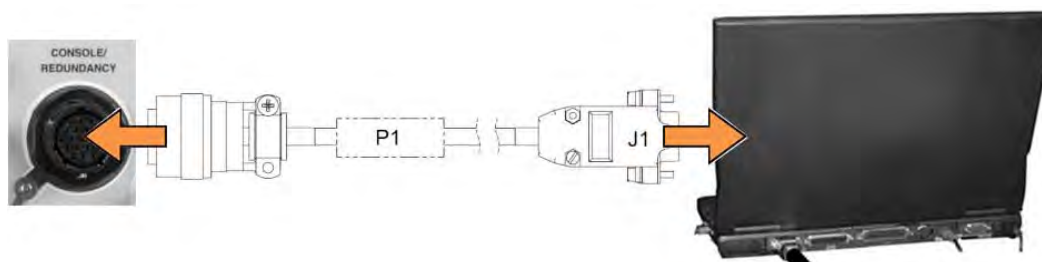

- b) On the PC: Open the terminal emulator program.



Refer to your terminal emulator program HELP feature or user guide for operating and configuration instructions.

Configure the utility program serial port communication and terminal display operation:

- 38400 bps (Baud Rate)
- 8 Data Bits
- 1 Stop Bit
- Parity = NO
- Port Flow Control = NONE
- Display New line Rx/Tx: CR
- Local Echo = ON

- c) On the ODM-840: Connect the power.

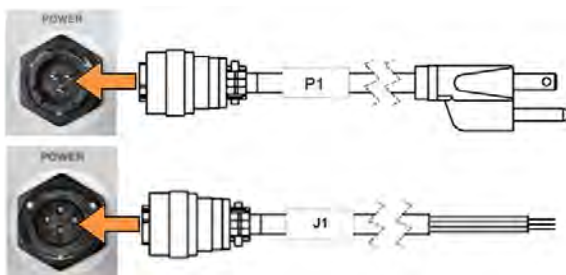

**ODM/R-840 Power Connection:**  
(TOP) AC Unit (standard on ODM-840)  
(BOTTOM) DC Unit (standard on ODMR-840, optional on ODM-840)



**d) On the PC: Make note of the information displayed on the ODM-840 Serial Interface:**

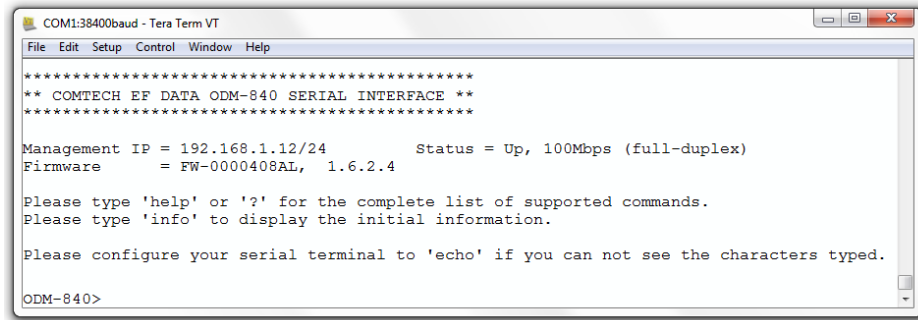

- Management IP Address (e.g., default is 192.168.1.12/24)
- Firmware Number, Revision Letter, and Release Version (e.g., FW-0000408AL, 1.6.2.4 – note that your firmware revision letter and release version may differ).



**Chapter 7. SERIAL-BASED REMOTE PRODUCT MANAGEMENT**

**e) Alternately, use the ODM-840 HTTP Interface to obtain the firmware information.**

- Use a user-supplied or available outdoor Ethernet cable to connect the ODM-840's Ethernet port directly to the PC or via an Ethernet hub or switch.

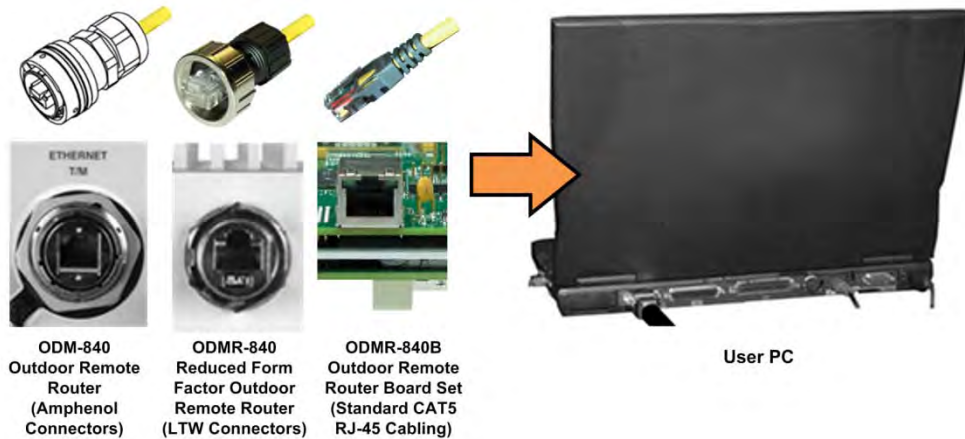

- On the PC: Use a Web browser (e.g., Internet Explorer) to log in to the ODM-840 HTTP Interface and access the 'Admin | Firmware' page. Then, make note of the Slot #1 and Slot #2 firmware loads:

**Slot Information**

Slot #	Running	Name	Version	Date	Size
1	Yes	FW-0000408AL	1.6.2.4		
2	No	FW-0000408AL	1.6.2.4		



**Chapter 6. ETHERNET-BASED REMOTE PRODUCT MANAGEMENT**

**2. Create a temporary folder (subdirectory) on the user PC for the firmware archive download.**



- Drive letter “c:” is used in these examples. Any valid, writable drive letter can be used.
- Typical for all tasks: Type the command without quotes, and then press Enter to execute.

There are several ways to create a temporary folder on a Windows-based PC:

**a) Use the Windows Desktop to create and rename the temporary folder.**

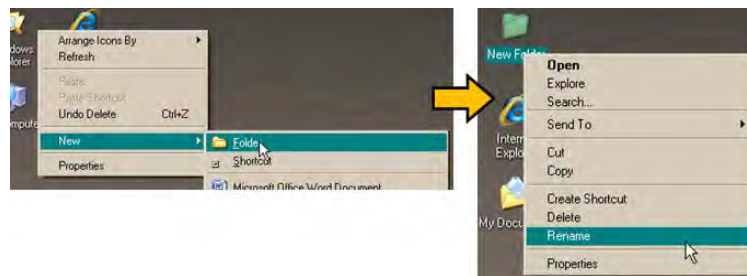

- Right-click anywhere on the desktop to open the popup submenu, and then select **New > Folder** to create the temporary folder. The new folder will be created on the desktop.
- Right-click on the new folder and then select **Rename** from the popup submenu. Rename this folder to “**temp**” or some other convenient, unused name.

**b) Use Windows Explorer to create and rename the temporary folder.**



- Select **File > New > Folder** to create the temporary folder. The new folder will be created in the active folder.
- Right-click the “**New Folder**” folder name, and then rename this folder to “**temp**” or some other convenient, unused name.

**c) Use the ‘Run’ and ‘Browse’ windows to create and rename the temporary folder.**

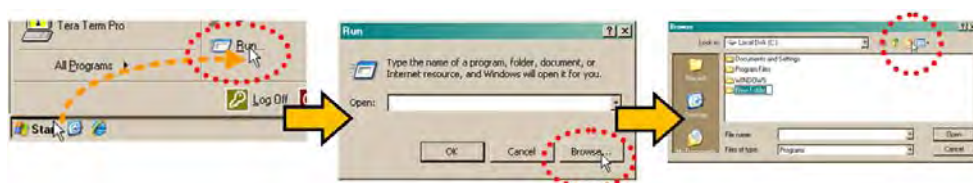

- Select **[Start]** on the Windows taskbar, and then click the Run... icon. The 'Run' window will open.
- Click **[Browse]** in the 'Run' window. The 'Browse' window will open.
- Click the Create New Folder icon in the 'Browse' window. The new folder will be created.
- Right-click the "New Folder" folder name, and then rename this folder to "temp" or some other convenient, unused name.

**d) Use Windows Command-line to create the temporary folder.**

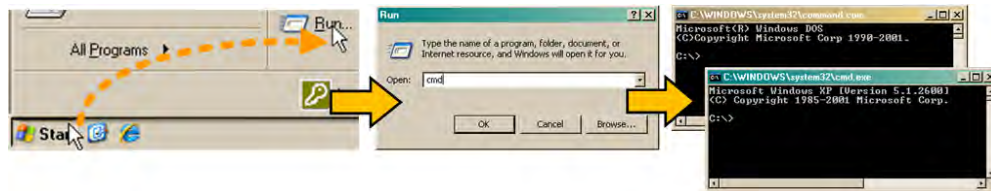

- **First**, click **[Start]** on the Windows taskbar, and then click the **Run...** icon (or, depending on Windows OS versions *prior* to Windows 95, click the **MS-DOS Prompt** icon from the Main Menu).
- **Then**, open a **Command-line** window...

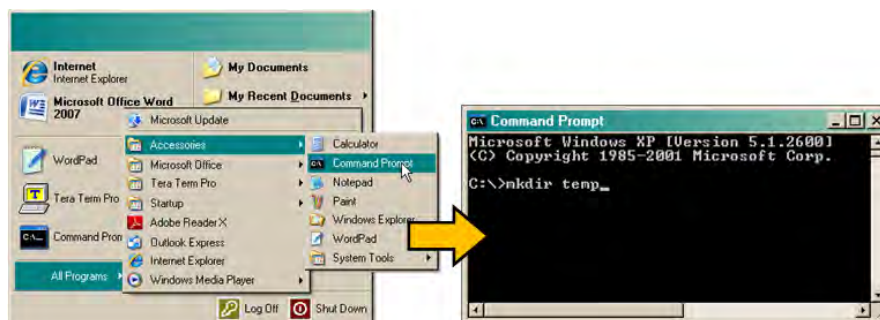

- For Windows 95 or Windows 98, type "command".
- For any Windows OS versions later than Windows 98, type "cmd" or "command".
- Alternately, from **[Start]**, select **All Programs > Accessories > Command Prompt**.
- Finally, from the **Command-line** "c:\>" prompt, type "mkdir temp" or "md temp" (*mkdir* and *md* stand for *make directory*), and then click **[OK]**.

***There should now be a "temp" folder created and available for placement of the firmware file download.***

## 4.3 Download and Extract the Firmware Update

Do these steps:

### 1. Acquire the firmware update archive file from Comtech EF Data Product Support.



- **About Firmware Numbers, File Versions, and Formats:** The Comtech EF Data Web site catalogues its firmware update files by product type (e.g., router, modem, etc.), the specific model, and optional hardware configurations.
- **About File Archive Formats:** Comtech EF Data provides its downloadable files in two compressed archive formats: **\*.exe** (self-extracting) and **\*.zip** (compressed).

The **\*.exe** file does not require a file archiver and compression utility program such as *PKZIP for Windows*, *WinZip*, *ZipCentral*, etc. (*PKZIP for DOS* is not supported due to file naming conventions). **Comtech EF Data does not provide this utility program.**

Some firewalls do not allow the download of **\*.exe** files. Download the **\*.zip** file instead, and extract the firmware files from the archive download with a user-supplied utility program. For detailed information on handling archived files, refer to the utility program Help documentation.

### 2. Transfer the archive file to the temporary folder.

- Once the **EXE** or **ZIP** hyperlink is selected the **'File Download'** window opens and prompts selection of **[Open]** or **[Save]**:
  - Click **[Open]** to turn over file extraction to the user-supplied utility program. Be sure to extract the firmware files to the **"temp"** folder created earlier.
  - Click **[Save]** to open the **'Save As'** window. Be sure to select and **[Save]** the archive **\*.exe** or **\*.zip** file to the **"temp"** folder created earlier.
  - Otherwise, click **[Cancel]** to quit and exit the file download process.



### 3. Extract the firmware files from the archive file.

- (If not already done with **File Download > [Open]**) Extract the firmware files from the downloaded **\*.exe** or **\*.zip** archive file with the user-supplied utility program:

- Double-click on the archive file name, and then follow the prompts provided by the user-supplied utility program. Extract, at a minimum, two files:
  - **FW0000408xx\_CDM840.bin** – the Firmware Bulk image file (where ‘xx’ denotes the revision letter), and
  - **CDM-840ReleaseNotes\_v#-#-#-#.pdf** – the Firmware Release Notes PDF file (where ‘#-#-#-#’ denotes the firmware version number).

#### 4. Confirm availability of the firmware files in the temporary folder.

There are several ways you may view the contents of the temporary folder on a Windows-based PC:

##### A. From the Windows Desktop:

- Double-left-click the “**temp**” folder saved to the Windows Desktop.
- Use **Windows Explorer** to locate, and then double-left-click the “**temp**” folder.
- Use the ‘**Browse**’ window ([**Start**] > ...**Run** > [**Browse**]) to locate, and then double-click the “**c:\temp**” folder.

##### B. Using Command-line:

- Type “**cd c:\temp**” at the Command-line prompt to change to the temporary directory created earlier using Command-line.
- Type “**dir**” to list the files extracted to the temporary directory from the downloaded archive file.

***The firmware files have been downloaded successfully, and they are now available for FTP transfer to the ODM-840.***

## 4.4 Perform the Ethernet FTP Upload Procedure



**YOU MAY PROCEED WITH THE FIRMWARE UPDATE PROCEDURE ASSUMING THAT:**

- **YOU HAVE CONNECTED THE ODM-840 TO A USER-SUPPLIED, WINDOWS-BASED PC AS FOLLOWS:**
  - **THE PC SERIAL PORT IS CONNECTED TO THE ODM-840 ‘CONSOLE/ REDUNDANCY’ PORT WITH A 19-PIN-TO-9-PIN ADAPTER SERIAL CABLE.**
  - **THE PC ETHERNET PORT IS CONNECTED DIRECTLY TO THE ODM-840 10/100 BASE-T ETHERNET PORT WITH THE AVAILABLE WEATHERPROOF ETHERNET ADAPTER CABLE OR WITH THE CABLE CONNECTED TO A USER-SUPPLIED HUB OR SWITCH.**
  - **THE PC IS RUNNING A TERMINAL EMULATION PROGRAM (FOR OPERATION OF THE ODM-840 SERIAL INTERFACE) AND A COMPATIBLE WEB BROWSER (FOR OPERATION OF THE ODM-840 HTTP INTERFACE).**
- **YOU HAVE NOTED THE ODM-840 MANAGEMENT/TRAFFIC IP ADDRESS USING THE ODM-840 SERIAL INTERFACE AND YOU HAVE IDENTIFIED THE FIRMWARE USING EITHER THE SERIAL INTERFACE OR THE ODM-840 HTTP INTERFACE ‘ADMIN | FIRMWARE’ PAGE.**
- **YOUR HAVE OBTAINED THE LATEST FIRMWARE UPDATE FROM COMTECH EF DATA PRODUCT SUPPORT, AND THE EXTRACTED FILES ARE AVAILABLE ON THE USER PC IN AN ACCESSIBLE TEMPORARY FOLDER.**

**Do these steps:**

**1. Use Command-line to send a “PING” command to confirm proper connection and communication between the user PC and the ODM-840:**

- **If the Management/Traffic IP Address of the unit is still not known**, type “info” at the Serial Interface **ODM-840>** command prompt and record the displayed information. Alternately, use Serial Remote Control or the ODM-840 HTTP Interface:
  - **Serial Remote Control** – Type the “<0/IPA?” remote query (without quotes) at the Serial Interface **ODM-840>** command prompt. The unit returns the configured Management/Traffic IP Address (>0000/IPA=192.168.1.12/24 (default)).
  - **ODM-840 HTTP Interface** – View the *IP Address/CIDR Mask* entry on the **‘Configuration | Interface | Mgt/Traffic’** page:



- **Once the Management/Traffic IP Address is known – use Command-line to PING:** Type “ping xxx.xxx.xxx.xxx” at the **Command-line** prompt (where ‘xxx.xxx.xxx.xxx’ is the unit Management/Traffic IP Address).

The response should confirm whether or not the unit is properly connected and communicating.

## 2. Use Command-line to transfer (FTP) the files from the user PC to the ODM-840:

- Type "ftp xxx.xxx.xxx.xxx" (where ‘xxx.xxx.xxx.xxx’ denotes the unit Management/Traffic IP Address).
- Enter the username and password assigned to the unit. The default username and password is “comtech”.
- Type “bin” to set the binary transfer mode.
- Type "put FW-0000408x\_CDM840.bin" (where ‘x’ denotes the revision letter) at the **Command-line** prompt, without quotes, to begin the file transfer. The process sequences through several blocks – this may take several minutes for the transfer to occur. Once the upgrade file is transferred the image is written to Flash memory and the unit transmits the message “**UPLOAD COMPLETE.**”



In the event you receive the “Connection closed by remote host.” message, wait another minute before continuing. The ODM-840 update sometimes takes longer than the FTP client allows.

- Type "bye" to terminate the FTP session, and then close the **Command-line** window.

## 3. Use the Serial Interface or the ODM-840 HTTP Interface ‘Admin | Firmware’ page to verify that the PC-to-Unit FTP file transfer was successful.

## 4. Use the ODM-840 HTTP Interface to select the firmware and reboot the unit:

### a) Select the desired Boot Slot (Image):

- Go to the ODM-840 HTTP Interface ‘Admin | Firmware’ page.
- Use the ‘**Boot From:**’ drop-down menu to select **Latest**, **Slot 1**, or **Slot 2** (in the **Firmware Configuration** section).



By default, the unit will boot from the Slot that stores the firmware version having the *latest date* (**Boot From: Latest**). ‘**Boot From:**’ may also be set to force the unit to boot up using either firmware image loaded in **Slot #1** or **Slot #2**.

- Click **[Submit]** to save the setting.

**b) Reboot the ODM-840:**

- Go to either the ODM-840 HTTP Interface 'Admin | Firmware' page or the 'Utility | Reboot' page.
- Click **[Reboot]** (in the *System Reboot* section) and **[OK]** when prompted, and then wait while the ODM-840 reboots.



***The ODM-840 is now operating with its latest firmware. The firmware update process is now complete.***



# Chapter 5. FAST ACTIVATION PROCEDURE



**UNLESS OTHERWISE NOTED** – This chapter collectively refers to the Comtech EF Data Advanced VSAT Series ODM-840 Remote Router, ODMR-840 Reduced Form Factor Remote Router, and ODMR-840B Remote Router Board Set as the ODM-840.

---

## 5.1 Overview

The ODM-840 Remote Router incorporates a number of optional features. In order to permit a lower initial cost, you may purchase the unit with only the desired features enabled.

If you wish to upgrade the functionality of a unit at a later date, Comtech EF Data provides Fully Accessible System Topology (FAST), which permits the purchase and activation of options through special authorization codes. You may contact Comtech EF Data Product Support to purchase these unique, register-specific Fast Access Codes, and then load these codes into the unit using the ODM-840 HTTP (Web Server) Interface (accessible by connecting your PC Ethernet port to the ODM-840's 'ETHERNET T/M' port).

**FAST System Theory:** FAST facilitates on-site upgrade of the operating feature set without removing a unit from the setup. FAST technology allows you to order a unit precisely tailored for the initial application. When your service requirements change, you can upgrade the topology of the unit to meet these requirements within minutes. This accelerated upgrade is possible because of FAST's extensive use of the programmable logic devices incorporated into Comtech EF Data products.

**FAST Implementation:** Comtech EF Data implements the FAST system in the modem at the factory. All FAST options are available through the basic platform unit at the time of order – FAST allows immediate activation of available options, after confirmation by Comtech EF Data, through the ODM-840 HTTP Interface.

**FAST Accessible Options:** You may order hardware options for installation either at the factory, or you can install and activate them on-site. The FAST Access Code that you purchase from Comtech EF Data enables configuration of the available hardware.

## 5.2 FAST Activation Using the HTTP Interface



### Sect. 6.3.2.3 ADMIN | FAST (Chapter 6. ETHERNET-BASED REMOTE PRODUCT MANAGEMENT)

Use the ODM-840 HTTP Interface ‘Admin | FAST’ page to manage ODM-840 FAST Features. This page provides scrollable list boxes that display the availability and activation status for all FAST options. FAST code entry/option activation control is also provided.

ODM-840 (ODM-840): Comtech EF Data Remote Router Active

UNIT STATUS: ONLINE  
STORED EVENT: 0  
TEST MODE: 0

TRANSMITTER ON: ON  
TX TRAFFIC: ON  
Rx TRAFFIC: ON  
GE LINK/ACTIVITY: ON

Working Mode: Router  
FW Version: 1.5.2.X

Rx Status: Lock  
Rx MODCOD: 32APSK 5/6  
Es/No (dB): 35  
BER: 0.000E0  
RSL (dBm): -25

Enhanced Mode

Home Admin Configuration Status Utility  
Access SNMP FAST Firmware Auto Logout VMS

#### FAST Configuration

Option	Status
Tx Data Rate	CCM: Up to 15Mbps, ACM: Up to 4.5Mps
Rx Data Rate	CCM: Up to 160Mbps
E1 Interface	RAN Optimization Enabled
Tx Header Compression	Enabled
Rx Header Decompression	Enabled
Tx Payload Compression	Enabled
Rx Payload Decompression	Enabled
Quality Of Service	Advanced QoS
G.703 Clock Extension	Enabled
Dynamic SCPC	Enabled

#### FAST Upgrade

Serial Number: 111111111

FAST Code:

Figure 5-1. ODM-840 HTTP Interface – ‘ADMIN | FAST’ Page

### 5.2.1 FAST Configuration

The *read-only* table in this section displays the ODM-840 available FAST Features and the operational status for each option:

Column	Description
Option	This column lists each available FAST Feature.
Status	This column identifies each FAST Feature operational parameter(s). If an option is not enabled, the column displays this information.

The complete roster of FAST Accessible Options is as follows:

Option	
CCM (VersaFEC only)	16 kbps – 256 kbps Tx Data/Symbol Rate
	16 kbps – 512 kbps Tx Data/Symbol Rate
	16 kbps – 1024 kbps Tx Data/Symbol Rate
	16 kbps – 2.048 Mbps Tx Data/Symbol Rate
	16 kbps – 5 Mbps Tx Data/Symbol Rate
	16 kbps – 10 Mbps Tx Data/Symbol Rate
	16 kbps – 15.35 Mbps Tx Data/Symbol Rate
CCM (DVB-S2 only)	1 – 15 Mbps Rx Data/Symbol Rate
	1 – 45 Mbps Rx Data/Symbol Rate
	1 – 100 Mbps Rx Data/Symbol Rate
G.703 Clock Extension	
dSCPC (Dynamic Single Carrier per Channel)	



- 1) **Tx Header and Payload Compression and Quality of Service (QoS)/Advanced QoS are standard (non-FAST) operational features for Comtech EF Data's Advanced VSAT Series group of products. If these features are listed in the FAST Configuration table, they are always indicated as Enabled.**
  
- 2) **E1 Interface operation is not available with the ODMR-840 Reduced Form Factor Remote Router or the ODMR-840B Board Set.**

## 5.2.2 FAST Upgrade

Do these steps to perform the ODM-840 FAST option upgrade:

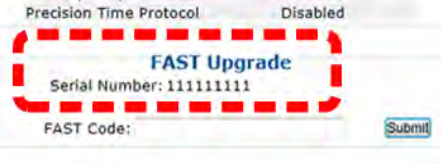
Step	Task
1	Use the <b>FAST Configuration</b> table to view the currently installed features. Any options that appear as <b>Disabled</b> in the table's <i>Status</i> column may be purchased as a FAST upgrade.
2	<p>The serial number of the unit is required by Comtech EF Data when ordering FAST option upgrades.</p>  <p>Take note of this number, provided here in the <b>FAST Upgrade</b> section, before contacting Comtech EF Data:</p> <p>Serial Number: _____</p>
3	<p>Contact Comtech EF Data Product Support:</p> <ul style="list-style-type: none"> <li>• Provide the unit Serial Number to the representative.</li> <li>• Identify and purchase the desired FAST option(s).</li> <li>• Obtain the invoice, the 20-digit FAST Access Code, and the FAST option activation instructions.</li> </ul>
4	Carefully enter the FAST Access Code into the <b>FAST Code</b> register text box.
5	Click <b>[Submit]</b> to execute the FAST Upgrade.
6	The unit either accepts or rejects the code, and the <b>FAST Configuration</b> table refreshes to reflect any upgrades in operation.



# Chapter 6. ETHERNET-BASED REMOTE PRODUCT MANAGEMENT



**UNLESS OTHERWISE NOTED** – This chapter collectively refers to the Comtech EF Data Advanced VSAT Series ODM-840 Remote Router, ODMR-840 Reduced Form Factor Remote Router, and ODMR-840B Remote Router Board Set as the ODM-840.

---

## 6.1 Introduction



1) **YOU MAY PROCEED WITH ETHERNET-BASED REMOTE PRODUCT MANAGEMENT (HTTP OR SNMP), ASSUMING THAT:**

- **YOU ARE OPERATING THE ODM-840 WITH THE LATEST VERSION FIRMWARE FILES.**
- **YOU HAVE CONNECTED THE ODM-840 TO A USER-SUPPLIED, WINDOWS-BASED PC AS FOLLOWS:**
  - **THE PC SERIAL PORT IS CONNECTED TO THE ODM-840 OR THE ODMR-840 ‘CONSOLE/REDUNDANCY’ PORT WITH A USER-SUPPLIED 19-PIN-TO-9-PIN SERIAL ADAPTER CABLE.**

**(THE ODMR-840B BOARD SET FEATURES A 26-PIN RIBBON CONNECTOR. CONTACT COMTECH EF DATA PRODUCT SUPPORT FOR INSTRUCTIONS ON COMPLETING ANY SERIAL-BASED CONNECTIONS FOR YOUR SPECIFIC ODMR-840B INSTALLATION.)**

- **THE PC ETHERNET PORT IS CONNECTED TO THE ODM-840’S ETHERNET PORT WITH THE AVAILABLE OUTDOOR ETHERNET CABLE, EITHER DIRECTLY OR WITH A USER-SUPPLIED HUB OR SWITCH.**
- **THE USER PC IS RUNNING A TERMINAL EMULATION PROGRAM (FOR OPERATION OF THE ODM-840 SERIAL INTERFACE) AND A COMPATIBLE WEB BROWSER (FOR OPERATION OF THE ODM-840 HTTP (WEB SERVER) INTERFACE).**

- **YOU HAVE NOTED THE ODM-840 MANAGEMENT/TRAFFIC IP ADDRESS USING THE ODM-840 SERIAL INTERFACE.**
- 2) **COMTECH EF DATA RECOMMENDS USE OF THE SERIAL REMOTE INTERFACE AND ETHERNET-BASED SNMP INTERFACE ONLY FOR ADVANCED USERS. ALL OTHER USERS ARE STRONGLY ENCOURAGED TO USE THE ODM-840 HTTP INTERFACE FOR MONITOR AND CONTROL (M&C) OF THE ODM-840.**
  - 3) **THE SERIAL AND HTTP INTERFACE FIGURES FEATURED THROUGHOUT THIS CHAPTER ARE INTENDED FOR USER REFERENCE ONLY AND ARE SUBJECT TO CHANGE. THE FIRMWARE INFORMATION (I.E., REVISION LETTERS, VERSION NUMBERS, ETC.) AS DISPLAYED MAY DIFFER FROM YOUR SETUP.**

---

## 6.2 Ethernet Management Interface Protocols

The User PC facilitates access to Ethernet-based remote monitor and control (M&C) of the ODM-840 through two separately-operated protocols:

- **Simple Network Management Protocol (SNMP).** This *non-secure interface* requires a user-supplied Network Management System (NMS) and a user-supplied Management Information Base (MIB) File Browser.
- **The ODM-840 HTTP (Web Server) Interface.** This *non-secure interface* requires a compatible user-supplied Web browser such as Internet Explorer.

### 6.2.1 Ethernet Management Interface Access

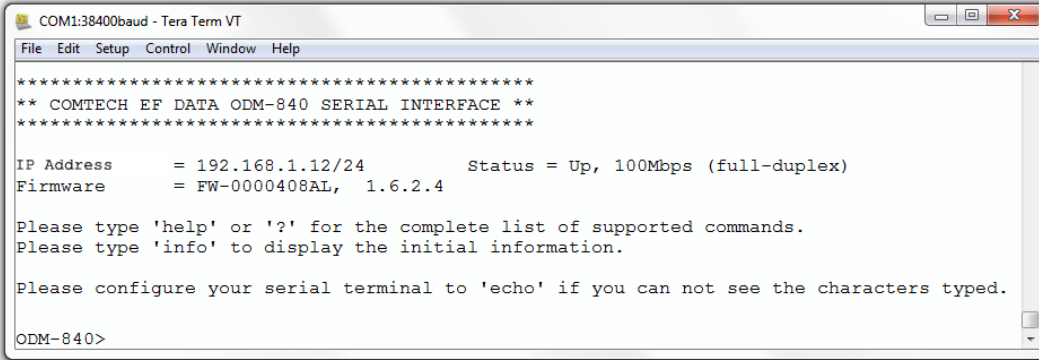

```
COM1:38400baud - Tera Term VT
File Edit Setup Control Window Help
*****
** COMTECH EF DATA ODM-840 SERIAL INTERFACE **
*****

IP Address      = 192.168.1.12/24          Status = Up, 100Mbps (full-duplex)
Firmware        = FW-0000408AL, 1.6.2.4

Please type 'help' or '?' for the complete list of supported commands.
Please type 'info' to display the initial information.

Please configure your serial terminal to 'echo' if you can not see the characters typed.

ODM-840>
```

**Figure 6-1. ODM-840 Serial Interface Example**

Access to the ODM-840 Ethernet Management Interface requires you to specify the unit Management/Traffic IP Address. You may be obtain this information via use of a terminal emulator connected with a user-supplied adapter cable to the 19-pin '**CONSOLE/REDUNDANCY**' (ODM-840 or the ODMR-840) or 26-pin (ODMR-840B) serial connector. As shown, a number of operational parameters (including the unit factory-default IP address) are displayed on the ODM-840 Serial Interface upon power-up of the unit.

The default (factory-assigned) IP address appears in the table that follows (if otherwise assigned, you may use the last column to write down the IP addresses for future reference):

Description	Default Address	User-assigned Address
Management/Traffic IP Address	192.168.1.12	_____

## 6.2.2 SNMP Interface

The *Simple Network Management Protocol (SNMP)* is an Internet-standard protocol for managing devices on IP networks. An SNMP-managed network consists of three key components:

- **The managed device.** This includes the ODM-840 Remote Router.
- **The SNMP Agent.** The software that runs on the ODM-840. The ODM-840 SNMP Agent supports both **SNMPv1** and **SNMPv2c**.
- **The user-supplied Network Management System (NMS).** The software that runs on the manager.

---

### 6.2.2.1 Management Information Base (MIB) Files

MIB files are used for SNMP remote management of a unique device. A MIB file consists of a tree of nodes called Object Identifiers (OIDs). Each OID provides remote management of a particular function. These MIB files should be compiled in a user-supplied MIB Browser or SNMP Network Monitoring System server. The following MIB files are associated with the ODM-840:

MIB File/Name (where 'x' is revision letter)	Description
<b>ComtechEFData.mib</b> ComtechEFData Root MIB file	ComtechEFData MIB file gives the root tree for ALL Comtech EF Data products and consists of only the following OID: <b>Name:</b> comtechEFData <b>Type:</b> MODULE-IDENTITY <b>OID:</b> 1.3.6.1.4.1.6247 <b>Full path:</b> iso(1).org(3).dod(6).internet(1).private(4).enterprises(1).comtechEFData(6247) <b>Module:</b> ComtechEFData
<b>FW-0000407x_CDM840.mib</b> ODM-840 MIB file	MIB file consists of all of the OIDs for ODM-840 M&C

## 6.2.2.2 SNMP Community Strings



**CAUTION** – In SNMP v1/v2c, the SNMP Community String is sent unencrypted in the SNMP packets. Caution must be taken by the network administrator to ensure that SNMP packets travel only over a secure and private network if security is a concern.

The ODM-840 uses Community Strings as a password scheme that provides authentication before gaining access to the ODM-840 Agent MIBs. They are used to authenticate users and determine access privileges to the SNMP Agent.

Type the SNMP Community String into the user-supplied MIB Browser or Network Node Management software.

Two Community Strings are defined for SNMP access:

- Read Community default = public
- Write Community default = private



**For proper SNMP operation, the ODM-840 MIB files must be used with the associated version of the ODM-840 Remote Router M&C. Refer to the ODM-840 FW Release Notes for information on the required FW/SW compatibility.**

## 6.2.3 ODM-840 HTTP Interface

A user-supplied Web browser allows the full monitoring and control (M&C) of the ODM-840 from its HTTP Interface. This *non-secure* embedded Web application is designed for, and works best with, Microsoft Internet Explorer Version 7.0 or higher.

### 6.2.3.1 User Login

Type the ODM-840 Management/Traffic IP Address (shown in this example as *http://xxx.xxx.xxx.xxx*) into the **Address** area of the User PC Web browser:



The login page, similar to the example shown here, opens. Enter the assigned **User Name** and **Password** – the default for both is **comtech**. Click **[Log On]**.

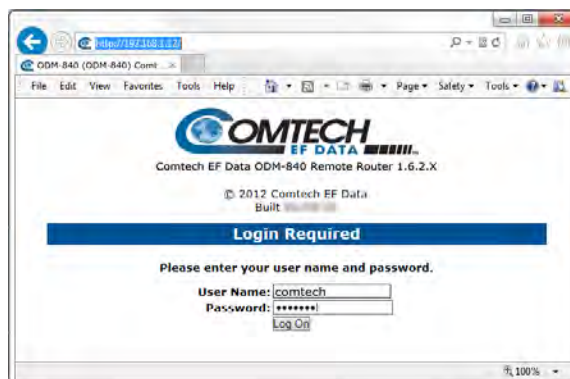



If the User Name and Password are accepted:  
The ODM-840 HTTP Interface ‘Home’ page,  
similar to this example, appears:



## 6.2.3.2 HTTP Interface – Operational Features

### 6.2.3.2.1 Virtual Front Panel



(TOP) Default Viewing Mode  
(BOTTOM) Enhanced Viewing Mode

**Figure 6-2. ODM-840 Remote Router Virtual Front Panel**

The top of every page in the ODM-840 HTTP Interface features a *read-only* ‘Virtual Front Panel’ (VFP). The interface appearance differs based on the selected viewing mode – Default or Enhanced Viewing Mode (**Figure 6-2**):

- The **Default** viewing mode features a text-based VFP and hyperlinks for web page access.
- Click the **Enhanced Mode** check box to change the interface appearance to the GUI viewing format. The **Enhanced Mode** features virtual LEDs and navigation tabs for web page access.

For either mode, the VFP banner displays the operational state as “Active” or “Inactive”:

- “Active” indicates to you that the page as displayed is “live” and up-to-date;
- “Inactive” indicates to you either that the page, as displayed, is “stale” and is not updating, or that the unit is in a transitional state (e.g., a reboot is in process).

Either VFP displays the ODM-840’s currently running FW (Firmware) Version. Additionally:

- **At left**, the VFP reports the status of the unit. In either viewing mode, the VFP updates the unit operation indicators in real time. In Enhanced Mode, the VFP provides operational LEDs (see **Sect. 6.2.3.2.1.1**).
- **At right**, the VFP displays (and updates in real time) the following parameters:
  - Working Mode (Fixed as Router)      ○ Firmware Version      ○ Rx Status
  - Rx MODCOD      ○ Es/No (dB)      ○ BER      ○ RSL (dBm)

### 6.2.3.2.1.1 Virtual LEDs

The Enhanced Mode virtual LEDs provide ‘heads-up’ operational status indicators that react to any changes made to unit operation, and convey operational states. To ensure that your web browser correctly displays the LED feature, Comtech EF Data recommends that you follow these configuration steps (this example uses Microsoft Internet Explorer):

Step	Task
1	On the <b>Tools</b> menu, click <b>Internet Options</b> .
2	On the <b>General</b> tabbed page: Under <b>Browsing history</b> , click <b>[Settings]</b> .
3	On the <b>Temporary Internet Files and History Settings</b> page: Under <b>Check for Newer Versions of Stored Pages</b> : click <b>Every Time I visit the webpage</b> .
4	Click <b>[OK]</b> to save the selection and close the <b>Temporary Internet Files and History Settings</b> page.
5	Click <b>[OK]</b> to close the <b>Internet Options</b> page.
6	Restart your browser.

The Enhanced Mode virtual LEDs indicate the active operating state of the unit as follows:

LED	State	Condition
UNIT STATUS	Green	No Unit Faults or Alarms.
	Amber	No Unit Faults, but an Alarm exists.
	Red	A Unit Fault exists ( <b>Example</b> : PSU fault).
STORED EVENT	Amber	There is a Stored Event in the log, which can be viewed from the HTTP Interface.
	Off	There are no Stored Events.
ONLINE	Green	The Unit is On Line, and carrying traffic.
	Off	The Unit is Off Line (standby) – forced by externally connected 1:1 or 1:N redundancy system.
TEST MODE	Amber	A Test Mode is selected.

LED	State	Condition
	Off	There is no Test Mode currently selected.
TRANSMITTER ON	Green	The Transmitter Carrier is <b>On</b> .
	Red	A Fault exists that causes the unit to turn off the carrier.
	Off	The Transmitter Carrier is <b>Off</b> .
Tx TRAFFIC	Green (solid)	No Tx Traffic Faults, no packets.
	Green (blinking)	No Tx Traffic Faults, blinks when a packet is being transmitted to the satellite link from this unit.
	Amber	A Tx Traffic Alarm exists.
	Red	Tx Traffic has a Fault.
	Off	The Tx is turned off.
Rx TRAFFIC	Green (solid)	No Rx Traffic Faults (demod and decoder are locked, everything is OK).
	Green (blinking)	No Rx Traffic Faults, blinks when a packet is being received from the satellite link to this unit.
	Amber	Rx Traffic has an Alarm.
	Red	Rx Traffic has a Fault.
GE LINK/ACTIVITY	Green (solid)	Traffic Ethernet is <b>connected</b> , but no traffic exists.
	Green (blinking)	Ethernet activity detected.
	Off	Traffic Ethernet is <b>not connected</b> .

### 6.2.3.2.2 Navigation

The ODM-840 HTTP Interface provides navigation aids at the top of each page, just below the Virtual Front Panel:

- **In default mode, hyperlinks are provided.** After you click a navigation hyperlink, you may click an available primary page hyperlink. In turn, any nested hyperlinks appear for further selection.
- **In Enhanced Mode, navigation tabs are provided.** After you click a navigation tab, you may click an available primary page tab. In turn, any nested tabs appear for further selection.



This manual uses a naming format for all Web pages to indicate the depth of navigation needed to view the subject page: “**Top Level Select | Primary Page Select | Nested Page Select**”.

**For example, ‘Status | Statistics | Traffic’** instructs you to “*first* click the top-level **Status** navigation tab; *then*, click the **Statistics** primary page tab; *finally*, click the nested **Traffic** tab.”

### 6.2.3.2.3 Page Sections

Each page features one or more sections. The title at the upper-left corner of each page or page section provides indicates its operational features. Each section can feature editable fields, action buttons, and *read-only* displays that are specific to that section.



This manual explains the purpose and operation for each web page on a *per-page, per-section* basis.

### 6.2.3.2.4 Action Buttons

Action buttons are important in the HTTP Interface. Click an action button to do one of these tasks:

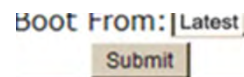

- Reset changed parameters to remove *unsaved* changes.
- Permanently save changes.
- Refresh the page with current data.



**If you edit a field, make sure to click the action button before you leave the page. If you go to another page without first clicking the action button, your changes are not saved.**

### 6.2.3.2.5 Drop-down Lists

A drop-down list lets you choose from a list of selections. Left-click the ▼ drop-down button to open the list. Then, left-click on an item to select that choice.

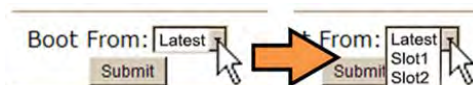

### 6.2.3.2.6 Text or Data Entry

Text boxes let you type data into a field. An action button may be associated with a single text box, or a group of text boxes. For any text box, left-click anywhere inside the box, type the desired information into that field, and be sure to press **[ENTER]** when done.

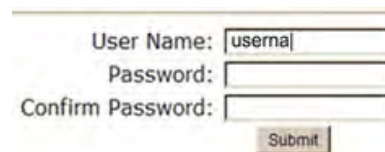

Click the related action button to save the data.



**If you edit a field, make sure to click the action button before you leave the page. If you go to another page without first clicking the action button, your changes are not saved.**

### 6.2.3.3 HTTP Interface Menu Tree Diagram



- 1) Any diagram block that is marked with (\*) denotes a page that is functional only when that optional FAST Feature has been purchased and activated. The diagram block marked with (\*\*) denotes that this page is functional only when a VIPERSAT MANAGEMENT SYSTEM (VMS), and a Block Up Converter (BUC) OR a Low Noise Block Down Converter (LNB) is installed and is recognized as operational.
  
- 2) E1 Interface operation is not available with the ODMR-840 Reduced Form Factor Remote Router or the ODMR-840B Board Set.

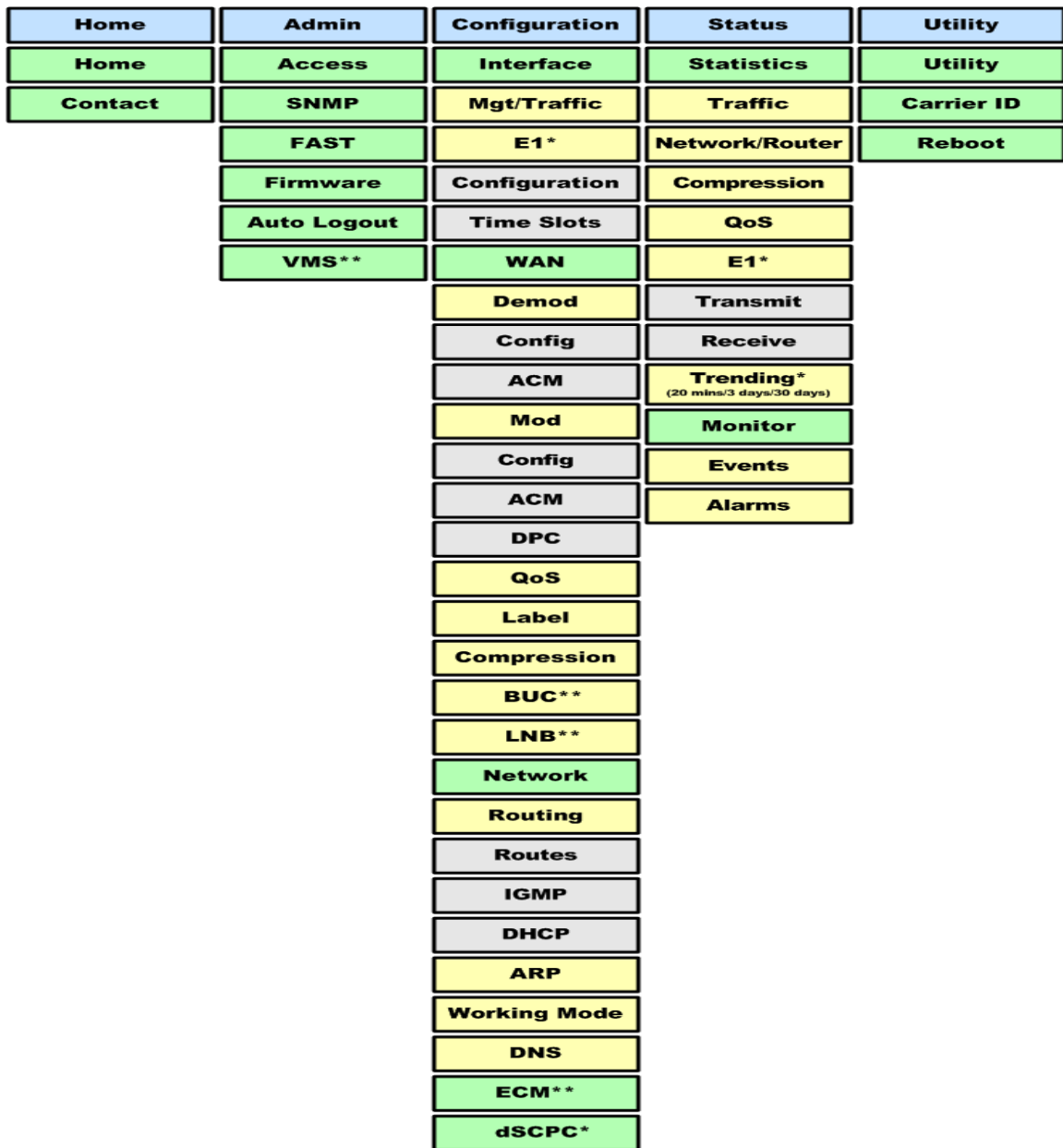

Figure 6-3. ODM-840 HTTP Interface – Menu Tree (FW Ver. 1.6.2.X)

**Figure 6-3** Illustrates the menu hierarchy for the ODM-840 HTTP Interface. It features five navigation tabs (shown in blue) located below the VFD at the top of each page. Primary page tabs (green) and nested page tabs (yellow or grey) grant access to individual web pages.

## 6.3 HTTP Interface Page Descriptions



- 1) Access to and availability of certain ODM-840 HTTP Interface pages depends upon the optional FAST Features purchased for operation, and/or the detected presence of auxiliary products (e.g., VIPERSAT Management System, Redundancy Switches, LNCs or BUCs, etc.) installed and configured for use with the ODM-840. Such operational restrictions will be noted in the subsections that follow through the end of this chapter.
- 2) The HTTP Interface page figures that follow depict the interface with Enhanced Mode selected. They do not show the page banner and VFP (Virtual Front Panel). These figures depict operational examples that will vary from your actual implemented network. They are provided for reference purposes only.

### 6.3.1 Home Pages

Click the **Home** or **Contact** tab to continue.

#### 6.3.1.1 Home | Home Page

Use this page to identify the product and its current operating firmware version. Click the **'Home'** navigation tab and/or the nested page tab to return to this page from anywhere in the HTTP Interface.

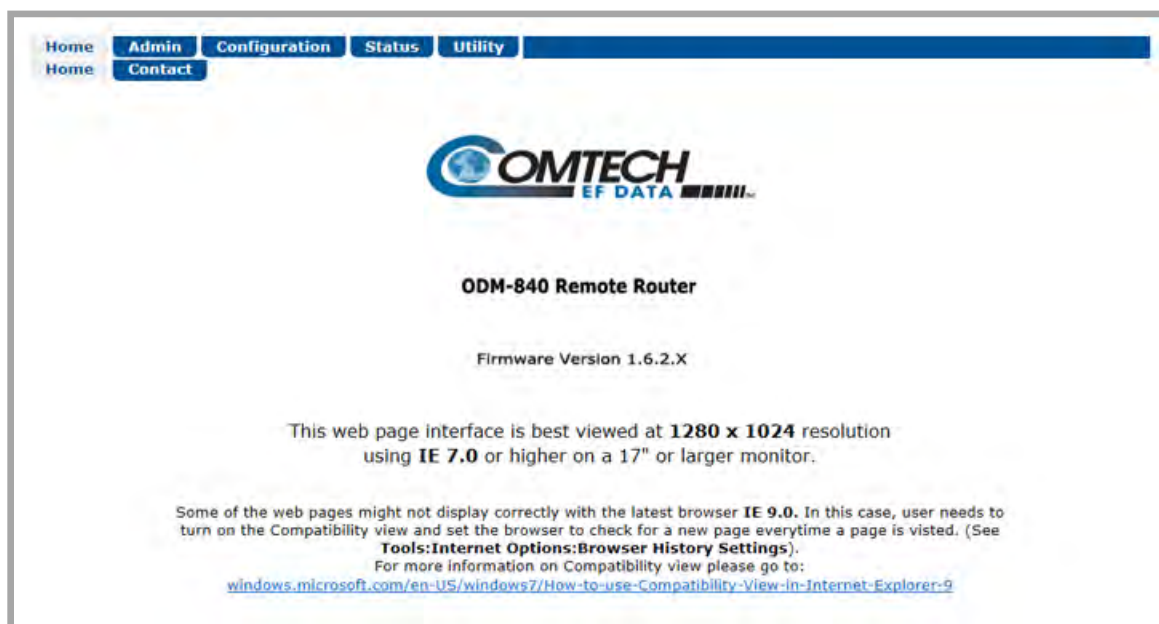

**Figure 6-4. Home | Home Page**

### 6.3.1.2 Home | Contact

For all product support, please call:

+1.240.243.1880

+1.866.472.3963 (toll free USA)

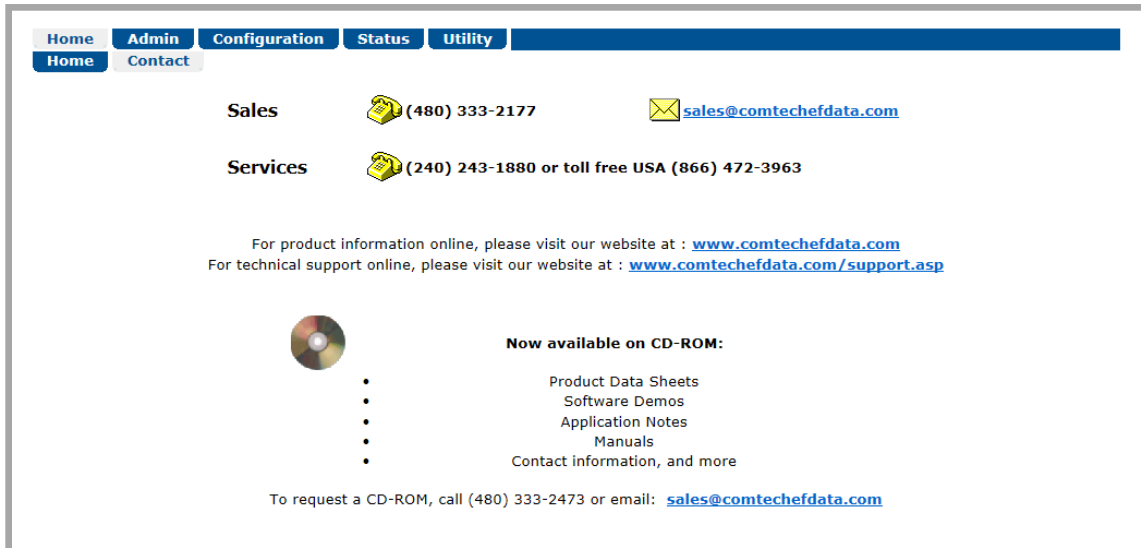

Figure 6-5. Home | Contact Page

## 6.3.2 Admin (Administration) Pages

Use these pages to set up user access, manage the firmware load preferences, and activate ODM-840 FAST features.



**The Admin pages are available only to users who have logged in using the Administrator Name and Password.**

Click the **Access**, **SNMP**, **FAST**, **Firmware**, **Auto Logout**, or **VMS** tab to continue.

---

### 6.3.2.1 Admin | Access

The Administrator must use this page to manage the ODM-840 HTTP Interface user access settings.

The screenshot shows the 'Admin | Access' page. At the top, there is a navigation bar with tabs for Home, Admin, Configuration, Status, Utility, Access, SNMP, FAST, Firmware, Auto Logout, and VMS. The 'Access' tab is currently selected. Below the navigation bar, the page title is 'User Access'. The main content area contains three text input fields: 'User Name: comtech (max length 15)', 'Password: \*\*\*\*\* (max length 15)', and 'Confirm Password: \*\*\*\*\*'. A 'Submit' button is located below the 'Confirm Password' field.

**Figure 6-6. Admin | Access Page**

#### User Access

- Enter a **User Name**. The **User Name** can be any alphanumeric combination with a maximum length of 15 characters. The factory default is **comtech**.
- Enter a **Password**. The **Password** can be any alphanumeric combination with a maximum length of 15 characters. The factory default is **comtech**.
- Re-enter the new **Password** in the **Confirm Password** text box.

Click **[Submit]** to save.



## 6.3.2.2 Admin | SNMP



### Sect. 6.2.2 SNMP Interface

The Administrator must use this page to manage the ODM-840 SNMP (Simple Network Management Protocol) settings.

The screenshot shows the 'Admin | SNMP' configuration page. At the top, there is a navigation bar with tabs for 'Home', 'Admin', 'Configuration', 'Status', and 'Utility'. Below this, a secondary bar contains sub-tabs for 'Access', 'SNMP', 'FAST', 'Firmware', 'Auto Logout', and 'VMS'. The main content area is titled 'SNMP Configuration' and features three rows of configuration options, each with a text input field and a 'Submit' button:

- SNMP Trap Destination IP Address:
- SNMP Read Community (length 4-15):
- SNMP Write Community (length 4-15):

Figure 6-7. Admin | SNMP Page

### SNMP Configuration

- Enter an **SNMP Trap Destination IP Address** in the form **XXX.XXX.XXX.XXX**.

Click **[Submit]** to save.

- Enter an **SNMP Read Community** string. This string can be any combination of characters and a length of 4 to 15 characters. The factory default string is **public**.

Click **[Submit]** to save.

- Enter an **SNMP Write Community** string. This string can be any combination of characters and a length of 4 to 15 characters. The factory default string is **private**.

Click **[Submit]** to save.

### 6.3.2.3 Admin | FAST

The ODM-840 has a number of optional features that you may activate after you purchase their unique authorization codes from Comtech EF Data Product Support. Use this page to enter these Fully Accessible System Topology (FAST) Access Codes.



See Chapter 5. FAST ACTIVATION PROCEDURE for instructions on using the ODM-840 HTTP Interface “FAST Upgrade” section.



QoS and Tx and Rx Header and Payload Compression are standard (non-FAST) operational features for Comtech EF Data’s Advanced VSAT Series group of products. If these features are listed in the FAST Configuration table, they are always indicated as Enabled.

The screenshot displays the 'Admin | FAST' page. At the top, there is a navigation bar with tabs for Home, Admin, Configuration, Status, and Utility. Under the 'Admin' tab, there are sub-tabs for Access, SNMP, FAST, Firmware, Auto Logout, and VMS. The main content area is titled 'FAST Configuration' and contains a table with the following data:

Option	Status
Tx Data Rate	CCM: Up to 15Mbps,ACM:Up to 4.5Msps
Rx Data Rate	CCM: Up to 160Mbps
E1 Interface	RAN Optimization Enabled
Tx Header Compression	Enabled
Rx Header Decompression	Enabled
Tx Payload Compression	Enabled
Rx Payload Decompression	Enabled
Quality Of Service	Advanced QoS
G.703 Clock Extension	Enabled
Dynamic SCPC	Enabled

Below the table is the 'FAST Upgrade' section, which includes a 'Serial Number: 11111111' and a 'FAST Code:' input field with a 'Submit' button.

Figure 6-8. Admin | FAST Page

## 6.3.2.4 Admin | Firmware



### Chapter 4. UPDATING FIRMWARE

The Administrator must use this page to select which image (boot Slot #) is to be designated as the *active running firmware image* – i.e., the version loaded for operation upon power-up or soft reboot.

The screenshot shows the Admin | Firmware page with a navigation bar at the top containing: Home, Admin, Configuration, Status, Utility, Access, SNMP, FAST, Firmware, Auto Logout, and VMS. The main content area is divided into three sections:

- Slot Information:** A table with columns: Slot #, Running, Name, Version, Date, and Size. The data is as follows:

Slot #	Running	Name	Version	Date	Size
1	Yes	FW-0000408AL	1.6.2.4		
2	No	FW-0000408AL	1.6.2.4		
- Firmware Configuration:** A form with a "Boot From:" dropdown menu set to "Latest" and a "Submit" button.
- System Reboot:** A form with a "Reboot" button.

Figure 6-9. Admin | Firmware Page

### Firmware Information

This *read-only* status section displays the operating status for the ODM-840 FW-0000408 firmware versions loaded into Slot #1 and Slot #2.

### Firmware Configuration

Use the **Boot From:** drop-down list to select **Latest**, **Slot 1**, or **Slot 2**. The default selection is **Latest**, in which the unit will automatically select the image that contains the most current firmware.

Click [**Submit**] to save. Note that the *Slot Information* section (**Figure 6-9** displays Slot #1 as the designated *active running firmware image*) does not update until *after* the unit is rebooted.

### System Reboot

Click [**Reboot**] to reboot the ODM-840. Once the unit reboots, you must log in once again to resume use of the HTTP Interface. See the '**Utility | Reboot**' page (**Sect. 6.3.5.3**) for further information.

### 6.3.2.5 Admin | Auto Logout

The Administrator must use this page to execute the Auto Logout security measure. When you configure Auto Logout, the active session terminates if the unit remains idle (i.e., when no user activity occurs) beyond your designated Logout Time. You must then log in with a valid user name and password to resume use of the ODM-840 HTTP Interface.

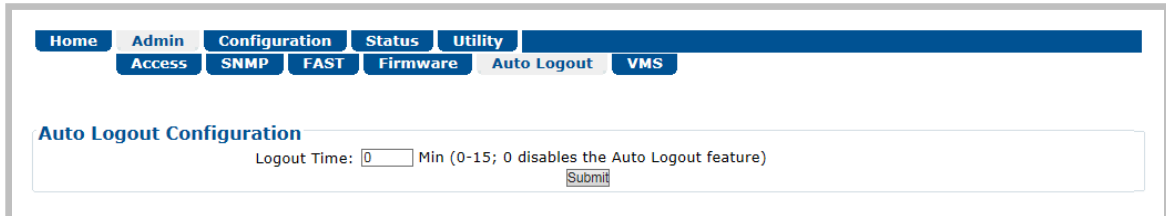

Home Admin Configuration Status Utility  
Access SNMP FAST Firmware Auto Logout VMS

**Auto Logout Configuration**

Logout Time:  Min (0-15; 0 disables the Auto Logout feature)

Submit

**Figure 6-10. Admin | Auto Logout Page**

#### Auto Logout Configuration

Set an automatic logout time to safeguard access to an already logged-in unit:

- Enter a value from **1** to **15** minutes into the **Logout Time** box to configure this feature.
- Enter a value of **0** to disable this feature.

Click **[Submit]** to save.

## 6.3.2.6 Admin | VMS



VMS v3.x.x VIPERSAT Management System User Guide (CEFD P/N MN/22156)

The screenshot shows the VMS Admin interface. At the top, there is a navigation menu with tabs for Home, Admin, Configuration, Status, and Utility. Under the Admin tab, there are sub-tabs for Access, SNMP, FAST, Firmware, Auto Logout, and VMS. The main content area is divided into two sections: Management System Configuration and Management System Status. The Management System Configuration section includes fields for Network ID, Management Base Port (set to 49152), and Management Multicast IP (set to 239.1.2.3). A Submit button is next to the Management Base Port field. A note below these fields states: "Note: In order to take control from VMS, please go to the Configuration->ECM page and disable ECM". The Management System Status section displays the VMS IP Address (0.0.0.0), Registration Status (Not Registered), and VMS Version (Not yet received).

Figure 6-11. Admin | VMS Page

### Management System Configuration

The valid operating ranges for items in this section are provided in parentheses.

- **Network ID** (1 to 254) – The **Network ID** designation defines to which network the Remote Router belongs. All devices in a common network will have the same Network ID. VMS uses the Network ID to identify Vipersat units within a network, and allows the VMS to manage multiple networks, each with its own unique network ID number.



**Starting with FW Ver. 1.6.2.X, the Network ID is configured in the CTOG-250 and automatically distributed to all ODM-840s that are locked and receiving the Outbound Carrier from the CTOG-250.**

- **Management Base Port**– The **Management Base Port** sets the starting IP port addressing for all VMS and ACM messages.



#### CAUTION – MAKE NOTE OF THE FOLLOWING:

- Use this setting **ONLY** if network port addressing is in contention. You should otherwise leave this setting at default (hex) C000 (dec) 49152 to avoid unnecessary configuration changes.
- If you change this port number (i.e., enter a value and click [Submit] to save), it will affect internal management operations across the entire network. You will be required to make configuration changes to all modems.
- While this page is operational only when the optional VIPERSAT MANAGEMENT SYSTEM (VMS) is installed and operational, the Management Base Port number is essential to proper operations with or without the VMS feature.

- **Management Multicast IP** – This is the Multicast IP Address assigned to all Vipersat network units to receive management messages from the VMS. This address must match the VMS Transmit Multicast Address.



**Starting with FW Ver. 1.6.2.X, the Management Multicast ID is configured in the CTOG-250 and automatically distributed to all ODM-840s that are locked and receiving the Outbound Carrier from the CTOG-250.**

Once the ODM-840 is registered in the Vipersat network, the VMS takes full management control of the *Data Rate*, *Symbol Rate*, *Frequency*, and *ModCod* demodulator parameters.

## Management System Status

This *read-only* section provides available information on the VMS's IP Address, Registration Status, and Version.

### 6.3.3 Configuration Pages



**MEO (Medium Earth Orbit) is not available in this firmware release. The MEO tab and its nested page, while available and selectable on this interface, are therefore NOT OPERATIONAL.**

Use the nested Configuration pages to configure all unit parameters. Dependent on availability, first click the **Configuration** tab, and then select the **Interface**, **WAN**, **Network**, **ECM**, or **dSCPC** tab to continue.

---

#### 6.3.3.1 Configuration | Interface Pages

Click the **Configuration | Interface** tabs, and then select the **MGT/Traffic** or **E1** tab to continue.

##### 6.3.3.1.1 Configuration | Interface | Mgt/Traffic

Use this page to configure the 'ETHERNET T/M' port. Note that this port serves as the Ethernet-based monitor and control interface between the ODM-840 and the user PC, and as the traffic interface.



**The Mgt/Traffic interface always operates in Router Mode. BPM (Bridge Point-to-Multipoint) Mode, a feature available with the CDM-840 Remote Router, is not available with the ODM-840.**

Home Admin Configuration Status Utility  
Interface WAN Network ECM dSCPC MEO  
Mgt/Traffic E1

**Mgt/Traffic Interface (Router Port)**  
MAC Address: 00:06:b0:02:47:ab  
IP Address/CIDR Mask: 192.168.1.12/24  
Link Configuration: Auto  
Negotiated Link Mode: 1000 Base-T/Full Duplex  
Submit

Figure 6-12. Configuration | Interface | Mgt/Traffic Page

#### Mgt/Traffic Interface (Router Port)

*The valid operating ranges for items in this section are provided in parentheses.*

- **MAC Address** (*read-only*) – Ethernet MAC Addresses are configured at the factory and cannot be changed. This MAC Address is unique for each available port.
- **IP Address / CIDR Mask** (8 to 30) – Use this box to enter the IP Address and CIDR (Classless Inter-Domain Routing) Subnet Mask.



**The configured subnets must be unique when in Router Mode. Overlapping the subnets is not allowed and such configuration requests will be rejected.**

- **Link Configuration** – Use the drop-down list to select the line speed and duplex setting for the ODM-840 FE interface. The available settings are **Auto\***, **10 BaseT/Half Duplex**, **10 BaseT/Full Duplex**, **100 BaseT/Half Duplex**, or **100 BaseT/Full Duplex**.



\* **Auto is the recommended configuration selection.**

- **Negotiated Link Mode** (*read-only*) – The actual negotiated line speed and duplex setting for the FE Interface is displayed here. The viewable settings are: **10 BaseT/Half Duplex**, **10 BaseT/Full Duplex**, **100 BaseT/Half Duplex**, or **100 BaseT/Full Duplex**.

Click [**Submit**] to save.



### 6.3.3.1.2 Configuration | Interface | E1 Pages (ODM-840 ONLY)



- 1) E1 Interface operation is not available with the ODMR-840 Reduced Form Factor Remote Router or the ODMR-840B Board Set.
- 2) These pages are functional only when the “G.703 E1 Interface / RAN Optimization” FAST and hardware options are installed and activated.

Click the **Configuration** or **Time Slots** tab to continue.

#### 6.3.3.1.2.1 Configuration | Interface | E1 | Configuration

Figure 6-13. Configuration | Interface | E1 | Configuration Page

#### E1 Configuration

- **Line Type** – Use the drop-down list to select **Framed**, **Framed-CRC**, or **Unframed**.
- **Line Coding** – Use the drop-down list to select **HDB3** or **AMI**.
- **WAN Loopback** and **Terrestrial Loopback** – Use the drop-down lists to select **Disable** or **Enable**.

Click **[Submit]** to save.

#### RAN Optimization



#### Appendix J. RAN/WAN OPTIMIZATION

RAN Optimization reduces the satellite bandwidth required for mobile backhaul. Use this section to select the level of optimization needed to achieve the desired link quality and bandwidth savings.

- **Hub RAN Optimizer IP Address** – Enter an IP address in the form XXX.XXX.XXX.XXX.
- **Hub RAN Optimization E1 Port ID** – Enter a numeric identification string for the rear panel ‘G.703 | IN / OUT’ port pair, corresponding to a specified corresponding port on the CXU-810 RAN Optimizer.
- **Optimization Level** – Use the drop-down list to select **Best Performance** or **Best Compression**.
- **Jitter Buffer Latency** – Use the drop-down list to select **10ms, 20ms, 30ms, 40ms, or 50ms**.
- **Alarm Relay** – Use the drop-down list to select **Disable** or **Enable**. Select **Enable** to both trigger the logging of operational faults or alarms on the ‘**Status | Statistics | E1 | Transmit / Receive**’ pages and toggle *on* the “**STORED EVENT**” LED on the HTTP Interface Virtual Front Panel (**Sect. 6.2.3.2.1.1**).

Click **[Submit]** to save.

## **E1 Port**

Access to G.703 Clock Extension operation defaults to **Enable** when this FAST option is activated. Use this drop-down list to otherwise select **Disable**.

Click **[Submit]** to save.

### 6.3.3.1.2.2 Configuration | Interface | E1 | Time Slots

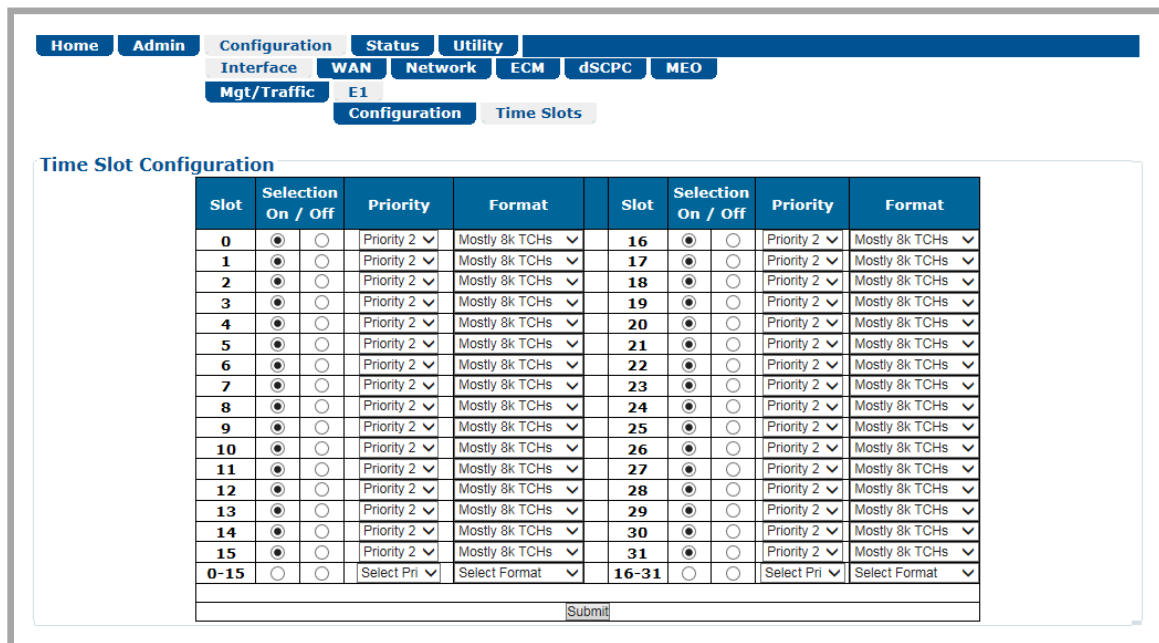

Figure 6-14. Configuration | Interface | E1 | Time Slots Page

#### Time Slot Configuration

Time Slots may be selected for transmission or reception up to the maximum dictated by the selected transmit or receive data rate, and may be selected in prioritized order. For example, if the Time Slot format is set to **Mostly 64k TCHs (Time Channels)**, the maximum number of Time Slots that can be dropped or inserted is 64 kbps. *From left to right:*

Column	Description
Slot	This <i>read-only</i> column identifies the assignable Time Slot (0 through 31).
Selection On / Off	Select the Time Slot as <b>On</b> or <b>Off</b> .
Priority	Use the drop-down list to select the Time Slot priority: <ul style="list-style-type: none"> <li>• Priority 1</li> <li>• Priority 2</li> <li>• Priority 3.</li> </ul>
Format	Use the drop-down list to select the Time Slot format: <ul style="list-style-type: none"> <li>• Mostly 8k TCHs</li> <li>• Mostly 16k TCHs</li> <li>• Mostly 32k TCHs</li> <li>• Mostly 64k TCHs</li> </ul>

Click **[Submit]** to save.

### 6.3.3.2 Configuration | WAN pages

Use the **WAN** pages to configure WAN-based operating parameters. Click the **Demod**, **Mod**, **QoS**, **Label**, **Compression**, **BUC**, or **LNB** tab to continue.

#### 6.3.3.2.1 Configuration | WAN | Demod Pages

Click the **Config** or **ACM** tab to continue.

##### 6.3.3.2.1.1 Configuration | WAN | Demod | Config

Use this page to configure ODM-840 Rx demodulator operations.

The screenshot shows the configuration page for the WAN Demodulator. The navigation tabs at the top include Home, Admin, Configuration, Status, and Utility. Under Configuration, there are sub-tabs for Interface, WAN, Network, ECM, dSCPC, and MEO. The WAN tab is active, and within it, the Demod, Mod, QoS, Label, Compression, BUC, and LNB sub-tabs are visible. The 'Config' sub-tab is selected.

**Demodulator**

Active		Alternate	
Data Rate:	0 (357.467-160000.000) Kbps	0	
Symbol Rate:	20000 (1000.000-62000.000) Ksps	20000	
<input type="button" value="Submit"/>			
Rx Frequency:	1200 (950.000-2150.000) MHz	1200	
MODCOD:	Auto	Auto	
Gold Code:	0 (0-262141)	0	
Es/No Alarm Point:	0 (-3.0 - 32.0) dB	0	
<input type="button" value="Submit"/>			

Roll Off: 35%  
Frame: Normal  
Pilots: Off  
Spectrum Invert: Normal

**Automatic Demod Configuration Switch**

Switch Enable:

Initial Switch Timer:  (10 - 3600) seconds  
Search Switch Timer:  (30 - 3600) seconds

(Note: Once the Alternate demod configuration has successfully locked, the Alternative configuration will automatically become the Active configuration)

**Receive WAN Labels**

Label 1:   
\* When using CDRP or BPM, Label Entry 1 will be used and it must be unique across all CDM-840s attached to the same CTOG-250/CDM-800

Label 2:   
Label 3:   
Label 4:   
(A WAN Label must match desired WAN route from the CDM-800)

**Demodulator Frequency**

Rx RF Frequency <input type="text" value="0"/> MHz (0-67080 MHz)	LNB LO Mix Low (-)	LNB LO Frequency <input type="text" value="0"/> MHz (0   3000-65000 MHz)	Rx L-Band Frequency <input type="text" value="1200"/> MHz (950-2080 MHz)
<input type="button" value="Submit"/>			<input type="button" value="Submit"/>

Note: LNB will not be uploaded  
LNB control can be found [here](#)

Figure 6-15. Configuration | WAN | Demod | Config Page

## Demodulator

**Demodulator**

Active		Alternate	
Data Rate:	<input type="text" value="0"/>	(357.467-160000.000) Kbps	<input type="text" value="0"/>
Symbol Rate:	<input type="text" value="20000"/>	(1000.000-62000.000) Ksps	<input type="text" value="20000"/>
<input type="button" value="Submit"/>			
Rx Frequency:	<input type="text" value="1200"/>	(950.000-2150.0000) MHz	<input type="text" value="1200"/>
MODCOD:	<input type="text" value="Auto"/>		<input type="text" value="Auto"/>
Gold Code:	<input type="text" value="0"/>	(0-262141)	<input type="text" value="0"/>
Es/No Alarm Point:	<input type="text" value="0"/>	(-3.0 - 32.0) dB	<input type="text" value="0"/>
<input type="button" value="Submit"/>			

Roll Off: 35%  
Frame: Normal  
Pilots: Off  
Spectrum Invert: Normal

The valid operating range for each item in this section is noted in parentheses.

- **Data Rate** (*read-only*) – This section displays the data rate, which is a snapshot of the MODCOD currently being received.
- **Symbol Rate** (1000 to 62000) – Enter the Active and Alternate symbol rates in **ksps**.

Click **[Submit]** to save.



***The Alternate column and its defined Symbol and Data rates are used only when the Automatic Demod Configuration Switch has been enabled.***

- **Rx Frequency** (950 to 2150 MHz) – Enter the Active and Alternate Rx frequencies in MHz.
- **MODCOD** – This section ALWAYS defaults to **Auto** mode.
- **Gold Code** (000000 to 262141) – The Gold-n Index descrambling code indicates the Physical Layer spreading sequence number. The default setting is all **0s**.
- **Es/No Alarm Point** (0.1 to 16.0) – This value, as calculated by the demodulator, is the energy per symbol bit (Es) divided by the noise spectral density (No). Enter the Es/No Alarm Point value, in dB.

Click **[Submit]** to save.



***The Alternate column and its defined Symbol and Data rates are used only when the Automatic Demod Configuration Switch has been enabled.***

- **Roll Off** (*read-only*) – The Rx Alpha Rolloff ( $\alpha$ ) dictates how fast the spectral edges of the carrier are attenuated beyond the 3 dB bandwidth. Roll Off is identified here as **20%**, **25%**, or **35%**.
- **Frame** (*read-only*) – The Framing type is identified here as either **Normal** or **Short**.

- **Pilots** (*read-only*) – Pilots operation is identified here as **Off** or **On**.
- **Spectrum Invert** (*read-only*) – Spectrum Inversion operation is identified here as either **Normal** or **Rx Spectrum Inverted**.

## Automatic Demod Configuration Switch

The Automatic Demod Configuration Switch allows you to enable and configure the “Alternate Demod” functionality. This feature allows you to pre-stage a new configuration for the outbound carrier – i.e., increase, decrease, or move the CTOG-250’s Outbound carrier. It is expected that this will be done as part of normal operations.

Do these steps:

Step	Task
1	Define the new desired outbound carrier parameters (symbol rate, frequency).
2	Configure the “Alternate Demod” configuration for all ODM-840s on the same Outbound Carrier (CTOG-250).
3	Configure the CTOG-250 to the new matching Tx parameters.
4	At this point, all of the ODM-840s will unlock from the old carrier, wait the “Initial Switch Timer” seconds and then try to Receive Lock to the “Alternate Demod” configuration.
5	If the initial attempt fails, then the demod will switch back and forth between the Active and the Alternate configuration until lock is achieved. This will occur every “Search Switch Timer” seconds.
6	Once a lock occurs, the successful configuration becomes the “Active” configuration and the other configuration becomes the “Alternate” configuration.

- **Switch Enable** – Use the drop-down list to set automatic switching between demod configurations as **Enable** or **Disable**.
- **Initial Switch Timer** – Enter a value from **10** to **3600** seconds. Use this setting to specify how long to wait after the demod goes unlocked before trying to lock onto the “Alternate Demod” parameters.
- **Search Switch Timers** – Enter a value from **30** to **3600** seconds. Use this setting to specify how long to wait between alternating attempts to “search” for the correct demod configuration. The “search” will stop once the demod has successfully locked onto the CTOG-250’s carrier.

Click **[Submit]** to save.

## Receive WAN Labels

**Receive WAN Labels**

Label 1

\* When using CDRP or BPM, Label Entry 1 will be used and it must be unique across all CDM-840s attached to the same CTOG-250/CDM-800

Label 2

Label 3

Label 4

(A WAN Label must match desired WAN route from the CDM-800)

Edit the **Label 1** through **Label 4** text boxes to suit. Each label has a valid range of 1 to 2047.



**Comtech EF Data strongly recommends, as required for ACM/VCM Operation, that your preferred method of operation should be to configure a unique WAN Label in Entry #1 for each ODM-840 across the network, and then enable CDRP on the CTOG-250. The associated Route to WAN Label will be automatically updated and maintained.**

**If you disable CDRP operation, you must take care to manually match the Receive WAN Labels to the WAN Labels assigned on the CTOG-250 Route Table.**

**Refer to the CTOG-250 Comtech Traffic Optimization Gateway with CDM-800 Gateway Router Installation and Operation Manual (CEFD P/N MN-CTOG250) for the CDM-800 configuration information.**

Click [**Submit**] to save.

## Demodulator Frequency

This Demodulator Frequency Calculator conveniently allows you to eliminate the guesswork associated between the demodulator's L-Band Frequency and the terminal's RF frequency. If the LNB LO Mix and LNB LO Frequency and either of the frequencies are known, then the other can be calculated. Use this calculator to start from either the Rx RF Frequency or Rx L-Band Frequency and calculate the "other" frequency.

here'."/>

**Demodulator Frequency**

Rx RF Frequency  MHz (0-67080 MHz)

LNB LO Mix  LNB LO Frequency  MHz (0 | 3000-65000 MHz)

Rx L-Band Frequency  MHz (950-2080 MHz)

Note: LNB will not be uploaded  
LNB control can be found [here](#)

*The valid operating range for each item in this section is noted in parentheses.*

- **Rx RF Frequency** (0 to 67080 MHz) – This is the frequency at which the terminal receives from the satellite. Once you enter a non-zero Rx RF Frequency or Rx L-Band Frequency value and enter the LNB LO Mix and LNB LO Frequency, the demodulator's Rx L-Band or RF Frequency will be automatically configured.

Enter the Rx RF Frequency in MHz. Click **[Submit]**. Upon submission, if you enter the LNB LO Frequency, the resulting Rx RF Frequency displays.

If the LNB LO Frequency is left at the default configuration of zero, the Rx RF Frequency will not be calculated.



**The LNB LO Mix and LNB LO Frequency entries are provided for calculation purposes only. LNB configuration is not updated as a result of configuring these parameters.**

- **LNB LO Mix** – Use this drop-down list to select the LNB LO (Low Oscillator) Mix as **Upconv (SUM):  $RF=LO+LBand$**  or **DownConv (Diff):  $RF=LO-LBand$** .



**Consult your LNB adjunct product datasheet or its Installation and Operation Manual for the type of LNB (Upconverter [Sum] or Downconverter [Diff]) being used.**

- **LNB LO Frequency** – Enter the known LNB Rx LO (Low Oscillator) Frequency in MHz.



**Consult your LNB adjunct product datasheet or its Installation and Operation Manual for the LO Frequency.**

- **Rx L-Band Frequency** (950 to 2150 MHz for L-Band, 50 to 180 MHz for IF) – Enter the L-Band or IF-Band frequency in MHz. Click **[Submit]**.



### 6.3.3.2.1.2 Configuration | WAN | Demod | ACM (Adaptive Coding and Modulation)



**VersaFEC ACM requires Version 1.3.2 or higher firmware and the appropriate FAST code for the maximum operating symbol rate.**

Use this page to configure ODM-840 Rx ACM operations.

**Figure 6-16. Configuration | WAN | Demod | ACM Page**

Outbound ACM allows you to configure a CTOG-250 Comtech Traffic Optimization Gateway to dynamically adjust the DVB-S2 MODCODs that are sent to each ODM-840 Remote Router, based on the conditions at that remote site. These conditions include antenna size, look angle and satellite band, as well as the current environmental conditions. Each ODM-840 will automatically and periodically send its Rx Es/No to the associated CTOG-250.

Requirements for ACM operation are as follows:

- Outbound ACM must be enabled at the CTOG-250.
- When Outbound ACM is disabled at the CTOG-250, all packets will revert to the “VCM Only MODCOD” which is configured in each QoS Group.
- Each ODM-840 must be locked to the Shared Outbound carrier from the CTOG-250.



**If an ODM-840 Remote Router reports that its demod is unlocked, the CTOG-250 ACM Controller will assign the lowest MODCOD (QPSK 1/4) to that remote in an effort to “recover” the remote. Once the remote locks again, the ACM algorithm adapts to the correct MODCOD for the reported Rx Es/No.**

- A return packet path is required from the ODM-840 to the CTOG-250 Management interface.

## Rx ACM Configuration

- **Rx Max MODCOD** – Use the drop-down list to select the maximum demodulation type and FEC rate (MODCOD). The available DVB-S2 selections are:
  - QPSK 1/4
  - QPSK 1/3
  - QPSK 2/5
  - QPSK 1/2
  - QPSK 3/5
  - QPSK 2/3
  - QPSK 3/4
  - QPSK 4/5
  - QPSK 5/6
  - 8PSK 3/5
  - 8PSK 2/3
  - 8PSK 3/4
  - 16APSK 2/3
  - 16APSK 3/4
  - 16APSK 5/6
  - 16APSK 9/10
  - 32APSK 3/4
  - 32APSK 4/5
  - 32APSK 5/6
  - 32APSK 9/10
- **Rx Target Es/No Margin** – Use the drop-down list to select a margin value, in 0.5 dB increments, from 0.0 to 4.5 dB.



**The ACM system is designed to switch based on thresholds that correspond to a BER of  $5 \times 10^{-8}$  for each MODCOD. However, in order to prevent oscillation around two MODCODs at this exact value, 0.3 dB of hysteresis has been added.**

- **CIR Threshold MODCOD** – Use the drop-down list to select the Committed Information Rate (CIR) Threshold MODCOD that is reported to the CTOG-250 and used by the Highly Degraded Remote feature. As long as the remote maintains a signal quality which corresponds to the CIR Threshold MODCOD or above, the CTOG-250 will continue to honor the configured CIR as expected.

If the Outbound assigned MODCOD for a given remote drops below the configured CIR Threshold MODCOD, the Qos Scheduler will scale back, if required, the throughput for the remote in order to prevent a highly-degraded remote from affecting the throughput of the entire outbound carrier.

Click **[Submit]** to save.

## Rx ACM Status

Information is presented in this *read-only* section as follows:

- **Rx ACM Enable** – Identifies ACM operation on the CTOG-250 as **Enabled** or **Disabled**.
- **Time Since Last Controller Announcement** – Amount of time in seconds since the ODM-840 received an announcement message from the CTOG-250.
- **Max Time Since Last Controller Announcement** – Maximum amount of time since the last announcement message was received from the CTOG-250.
- **ACM/VCM Controller IP Address** – The assigned IP Address for the Controller. This will be the Management IP Address for the associated CTOG-250.

### 6.3.3.2.2 Configuration | WAN | Mod (Modulator) Pages

Click the **Config**, **ACM**, or **DPC** tab to continue.

#### 6.3.3.2.2.1 Configuration | WAN | Mod | Config

Use this page to configure ODM-840 Tx modulator operations.

The screenshot displays the 'Modulator' configuration page. At the top, there are navigation tabs: Home, Admin, Configuration, Status, and Utility. Under 'Configuration', there are sub-tabs: Interface, WAN, Network, ECM, dSCPC, MEO, Demod, Mod, QoS, Label, Compression, BUC, and LNB. The 'Mod' tab is selected, and within it, 'Config', 'ACM', and 'DPC' are visible. The main content area is titled 'Modulator' and contains the following fields:

- Data Rate: 200 (16.000-15358.508) Kbps
- Symbol Rate: 141.734 (16.000-4500.000) Ksps
- FEC Type: VersaFEC
- Tx Frequency: 1205 (950.0000-2150.0000)MHz
- MODCOD: VersaFEC MODCOD 3 QPSK 0.706
- Note: (Note: in CCM mode, changing the MODCOD setting will change the Symbol Rate automatically)
- Tx Scrambler: Normal
- Roll Off: 35%
- Spectrum Invert: Normal
- Power Level: -15 (-40.0 - 0.0) dBm
- Carrier State: Off

Below the 'Modulator' section is the 'RTI Configuration' section:

- Transmit Inhibit: Disable
- Wait Time: 5 (1..10) Seconds
- State: Disabled

At the bottom is the 'Modulator Frequency' section:

- Tx RF Frequency: 0 (0-67150.0000) MHz
- BUC LO Mix: Low (-)
- BUC LO Frequency: 0 (0 | 3000-65000) MHz
- Note: BUC will not be uploaded. BUC control can be found [here](#).
- Tx L-Band Frequency: 1205 (L-Band: 950.0000-2150.0000) MHz

Figure 6-17. Configuration | WAN | Mod | Config Page

### Modulator

This is a close-up view of the 'Modulator' configuration section. It shows the following fields and values:

- Data Rate: 200 (16.000-15358.508) Kbps
- Symbol Rate: 141.734 (16.000-4500.000) Ksps
- FEC Type: VersaFEC
- Tx Frequency: 1205 (950.0000-2150.0000)MHz
- MODCOD: VersaFEC MODCOD 3 QPSK 0.706
- Note: (Note: in CCM mode, changing the MODCOD setting will change the Symbol Rate automatically)
- Tx Scrambler: Normal
- Roll Off: 35%
- Spectrum Invert: Normal
- Power Level: -15 (-40.0 - 0.0) dBm
- Carrier State: Off



**The upper range of Data and Symbol Rate selection requires activation of the TRANSMIT DATA RATE FAST option.**

Select or enter the desired FEC Type, Tx Frequency, MODCOD, Tx Scrambler, Spectrum Invert, and Carrier State settings. Click **[Submit]** to save. **The valid operating range for each item in this section is noted in parentheses:**

- **Data Rate** (16 to 15343 kbps) – Enter The ODM-840 Tx Data Rate in **kbps**. Click **[Submit]** to save.



**When Adaptive Coding and Modulation (ACM) is set to Enable, the Data Rate is set automatically. Manual configuration of Data Rate is disabled and the appearance of the Data Rate section changes as follows:**



- **Symbol Rate** (16 to 4500 kbps) – Enter The ODM-840 Tx Symbol Rate in **ksps**. Click **[Submit]** to save.
- **FEC Type** – At present, **VersaFEC** is the sole available FEC type.
- **Tx Frequency** (950 to 2150 MHz) – Enter The ODM-840 Tx frequency in **MHz**.
- **MODCOD** (applicable only to CCM Mode) – Use the drop-down list to select the Modulation type and FEC rate (MODCOD). The available selections are:
  - VersaFEC MODCOD 0 – BPSK 0.488
  - VersaFEC MODCOD 1 – QPSK 0.533
  - VersaFEC MODCOD 2 – QPSK 0.631
  - VersaFEC MODCOD 3 – QPSK 0.706
  - VersaFEC MODCOD 4 – QPSK 0.803
  - VersaFEC MODCOD 5 – 8-QAM 0.642
  - VersaFEC MODCOD 6 – 8-QAM 0.711
  - VersaFEC MODCOD 7 – 8-QAM 0.780
  - VersaFEC MODCOD 8 – 16-QAM 0.731
  - VersaFEC MODCOD 9 – 16-QAM 0.780
  - VersaFEC MODCOD 10 – 16-QAM 0.829
  - VersaFEC MODCOD 11 – 16-QAM 0.853
- **Tx Scrambler** – Use the drop-down list to select the Tx Scrambler as **Off** or **Normal**.
- **Roll Off** – The Tx Alpha Rolloff ( $\alpha$ ) dictates how fast the spectral edges of the carrier are attenuated beyond the 3 dB bandwidth. With 20% rolloff the edge falls off more quickly than with 25% and 35%.

Use the drop-down list to set the expected filter Tx Alpha Rolloff ( $\alpha$ ) of the carrier as **20%**, **25%**, or **35%**. The default selection is **20%**.

- **Spectrum Invert** – Use the drop-down list to select the Tx Spectrum Invert as **Normal** or **Tx Spectrum Inverted**.

- **Power Level** (-40 to 0 dBm) – Enter the Tx power level in **dBm**.
- **Carrier State** – Use the drop-down list to select the Tx Carrier State as **Off** or **On**.

## RTI Configuration

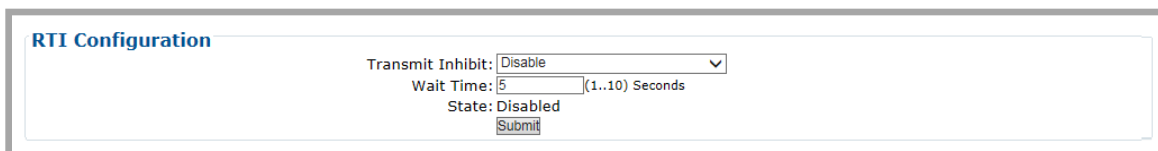

**RTI means RECEIVE/TRANSMIT INHIBIT. When selected, it will prevent the Tx carrier from being transmitted until the demodulator is locked. To avoid the Tx Carrier from being turned off when the demodulator loses lock for a very short period of time, the demodulator must be unlocked continuously for the selected time period (1 to 5 seconds) before the transmit carrier is inhibited.**

Set the desired **Transmit Inhibit** and **Wait Time**. Click **[Submit]** to save:

- **Transmit Inhibit** – Use the drop-down list to:
  - **Disable**;
  - **Enable** – The Transmitter will be disabled with the Receive lock has been lost for “Wait Time” number of seconds;
  - **Enable – Tx Carrier/Traffic Ethernet** – The Transmitter and Traffic Ethernet will be disabled with the Receive lock has been lost for “Wait Time” number of seconds.



**Selecting this option will disable Ethernet management along with Ethernet traffic because they share the same Ethernet interface.**

- **Wait Time** – Enter a time, in seconds, to delay execution of the RTI function (when Enabled). The range is from **1** to **5** seconds.
- **State** (*read-only*) – The operational status of the RTI function is displayed here.

## Modulator Frequency

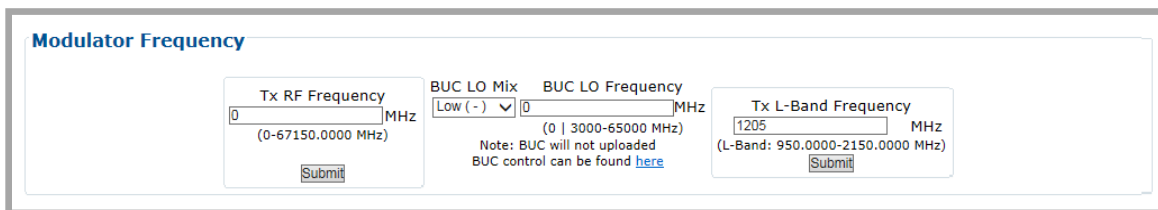

This Modulator Frequency Calculator conveniently allows you to eliminate the guesswork associated with the modulator’s L-Band Frequency and the terminal’s RF frequency. If the BUC

LO Mix and BUC LO Frequency and either of the desired frequencies are known, then the other can be calculated. Use this calculator to start from either the Tx RF Frequency or Tx L-Band Frequency and calculate the “other” frequency.

*The valid operating range for each item in this section is noted in parentheses.*

- **Tx RF Frequency** (0 to 67150 MHz) – This is the frequency at which the terminal transmits to the satellite. Once you configure this to a non-zero value and enter a BUC LO Mix and BUC LO Frequency, the modem automatically configures the L-Band or IF frequency. Enter the Tx RF Frequency in MHz. Click **[Submit]**. Once you submit the Tx Rx Frequency and you enter a BUC LO Frequency, the modem displays the resulting Tx RF Frequency.

If you leave the BUC LO Frequency at the default setting of zero, then the modem does not calculate the Tx RF Frequency.



**The BUC LO Mix and BUC LO Frequency entries are provided for calculation purposes only. BUC configuration is not updated as a result of configuring these parameters.**

- **BUC LO Mix** – Use this drop-down list to select the BUC LO (Low Oscillator) Mix as **Upconv (SUM):  $RF=LO+LBand$**  or **DownConv (Diff):  $RF=LO-LBand$** .



**Consult your BUC adjunct product datasheet or its Installation and Operation Manual for the type of BUC (Upconverter [Sum] or Downconverter [Diff]) being used.**

- **BUC LO Frequency** – Enter the known BUC Tx LO (Low Oscillator) Frequency in MHz.



**Consult your BUC adjunct product datasheet or its Installation and Operation Manual for the LO Frequency.**

- **Tx L-Band Frequency** (950 to 2150 MHz for L-Band, 50 to 180 MHz for IF) – Enter the L-Band or IF-Band frequency in MHz. Click **[Submit]**.

### 6.3.3.2.2 Configuration | WAN | Mod | ACM



**VersaFEC ACM requires Version 1.3.2 (or higher) firmware, and the appropriate FAST code for the maximum operating symbol rate.**

Use this page to configure ODM-840 Tx ACM operations.

The screenshot shows the configuration page for WAN | Mod | ACM. The navigation menu includes Home, Admin, Configuration, Status, and Utility. Under Configuration, there are sub-menus for Interface, WAN, Network, ECM, dSCPC, and MEO. Under WAN, there are sub-menus for Demod, Mod, QoS, Label, Compression, BUC, and LNB. Under Mod, there are sub-menus for Config, ACM, and DPC.

**Tx ACM Configuration**

ACM Enable:    
 Max MODCOD:    
 Target Es/No Margin:

**Tx ACM Status (List all 880s)**

Seconds since last LQRM:	Max Seconds since last LQRM:	IP Source of last LQRM:	Last Reported Es/No:	Current Modcod	Current DataRate
ACM Disabled	13313	Not yet received first msg	Unlocked	QPSK .706 (3)	200 Kbps

**Tx ACM Events**

Date	Time	Reported Es/No	New ModCod	New Tx DataRate	880 IP
		0	0	0	0.0.0.0

Figure 6-18. Configuration | WAN | Mod | ACM Page

#### Tx ACM Configuration

- **ACM Enable** – Use the drop-down list to **Disable** or **Enable** Tx ACM operation.



**With ACM set to Enable, the Configuration | Mod | Config page updates to disable manual configuration of the Max MODCOD (Data Rate) parameter.**

- **Max MODCOD** – Use the drop-down list to select the maximum Modulation type and FEC rate (MODCOD). The available selections are:
  - VersaFEC MODCOD 0 – BPSK 0.488
  - VersaFEC MODCOD 1 – QPSK 0.533
  - VersaFEC MODCOD 2 – QPSK 0.631
  - VersaFEC MODCOD 3 – QPSK 0.706
  - VersaFEC MODCOD 4 – QPSK 0.803
  - VersaFEC MODCOD 5 – 8-QAM 0.642
  - VersaFEC MODCOD 6 – 8-QAM 0.711
  - VersaFEC MODCOD 7 – 8-QAM 0.780
  - VersaFEC MODCOD 8 – 16-QAM 0.731
  - VersaFEC MODCOD 9 – 16-QAM 0.780
  - VersaFEC MODCOD 10 – 16-QAM 0.829
  - VersaFEC MODCOD 11 – 16-QAM 0.853
- **Target Es/No Margin (0.0 to 4.5)** – Use the drop-down list to select a margin value, in 0.5 dB increments.



**The ACM system is designed to switch based on thresholds that correspond to a BER of  $5 \times 10^{-8}$  for each MODCOD. However, in order to prevent oscillation around two MODCODs at this exact value, 0.3 dB of hysteresis has been added.**

Click **[Submit]** to save.

## Tx ACM Status (List all 880s)

From left to right:

Column	Description
Seconds since last LQRM	Amount of time (in seconds) since an LQRM (Link Quality Report Message) message was received from the associated CDD-880 Multi Receiver Router.
Max Seconds since last LQRM	Maximum amount of time since the last LQRM message was received.
IP Source of last LQRM	The source IP Address from where the last LQRM message was received.
Last Reported Es/No	Es/No value received in the last LQRM message.
Current MODCOD	Currently selected MODCOD.
Current DataRate	Current data rate based on current symbol rate and MODCOD.

Click the **List all 880s** hyperlink in the section header to display the CDD-880 Multi Receiver Routers incorporated into the active Advanced VSAT Network. The page will update to display this information:

Index:	IP:	Current State	Last Reported Es/No:	Max Seconds since last LQRM:
1	10.7.61.189	Active	250	13

Number of 880s: 1

From left to right:

Column	Description
Index	The recognized CDD-880 is automatically assigned this internal index number.
IP	The source IP Address of the CDD-880.
Current State	Displays the state as Dead, Active, or Recovery.
Last Reported Es/No	Es/No value received in the CDD-880's last LQRM message.
Max Seconds Since last LQRM	Maximum amount of time since the last LQRM message was received from the CDD-880.

Click the **Configuration | WAN | Mod | ACM** page tab to resume use of the HTTP Interface.

## Tx ACM Events

In addition to the date- and time-stamp assigned for each event, information is presented in this *read-only* section as follows (*from left to right*):

Column	Description
Reported Es/No	Es/No value.
New MODCOD	Newly selected MODCOD.
New Tx DataRate	New data rate based on new MODCOD and current symbol rate.

Click **[Clear ACM Events]** to clear all ACM statistics from the buffer.



### 6.3.3.2.2.3 Configuration | WAN | Mod | DPC



- See adjunct CEFD publication VMS v3.x.x VIPERSAT Management System User Guide (CEFD P/N MN/22156)
- Appendix L. DPC (VMS DYNAMIC POWER CONTROL)

DPC is a selectable software feature operating independently on ODM-840s exchanging a UDP message between the receiving unit (where the signal quality is being measured) and the transmitting unit (where the power level is to be adjusted). This message contains link quality status, which is directed to the transmit site on timed intervals, updating the link state.

Use this page to configure and monitor ODM-840 Tx Dynamic Power Control operations.

The screenshot displays the 'Tx Dynamic Power Control (DPC) Configuration' page. The navigation menu at the top includes Home, Admin, Configuration, Status, and Utility. Under Configuration, there are sub-menus for Interface, WAN, Network, ECM, dSCPC, and MEO. Under WAN, there are sub-menus for Demod, Mod, QoS, Label, Compression, BUC, and LNB. Under Mod, there are sub-menus for Config, ACM, and DPC. The main content area is divided into two sections: 'Tx Dynamic Power Control (DPC) Configuration' and 'Tx Dynamic Power Control (DPC) Status'. The configuration section includes fields for DPC Enable (set to Disabled), Maximum Data Rate (0 kbps), Terminal Maximum Power (Not Set dBm), and Tx Power Margin (0 dB). There are buttons for Submit, Recalculate Max Power, Reset Max Power, Turn All DPC Settings Off, and Reset All Parameters to Factory Default. The status section shows Current Beam offset: 0 dB, Target EsNo: 14.3 dBm, Last EsNo Received: Not locked, Current DPC Delta: 0 dB, and Time since last LQRM: 4592. The Power Reference section shows Reference Tx Power: 0 dBm, Reference MODCOD: undefined, and Reference Symbol Rate: 0 ksps, with a Set Reference button and a note that setting references will force a reload of the page when successful.

Figure 6-19. Configuration | WAN | Mod | DPC Page

#### Tx Dynamic Power Control (DPC) Configuration

- **DPC Enable** – Use the drop-down list to select **Disabled** or **Enabled**.
- **Maximum Data Rate** (16 kbps to 15.35 Mbps) – Enter a maximum data rate value.
- **Terminal Maximum Power** – Enter a value, in dBm.
- **Tx Power Margin** (0 to 40) – Enter a value, in dB.

Click **[Submit]** to save.

- **Rated Maximum Power (read-only)** – This displays the highest value that DPC will raise the power to during normal operation. This value is calculated from the references, Maximum Data Rate, and Tx Power Margin.
  - Click **[Recalculate Max Power]** to recalculate the Rated Maximum Power whenever you change the Tx Power Margin and/or the Maximum Data Rate.
  - Click **[Reset Max Power]** to set the Maximum Power to an invalid value. Use this setting when recalibrating references, when the previous settings do not allow DPC to reach the target Es/No.
  - Click **[Reset All Parameters to Factory Default]** to completely disable DPC, remove the references, and to return all settings to the factory default.

### Tx Dynamic Power Control (DPC) Status

Once reference calibration is complete, this section provides information on the ongoing DPC state. Each received LQRM updates this status section; any changes to power are noted between **Target Es/No** and **Current DPC Delta**.

After the targeting of reference calibration, the DPC Delta is zeroed, and any +/- offset from this point indicates power changes due to link quality variations.



**Depending on symbol rate, small rates will have variations up to ±.5 dB, even during clear-sky conditions.**

Item	Description
Current Beam offset	Current Beam offset is modified in a roam configuration, and any +/- offset from zero either adds or subtracts from the margin or terminal maximum power backoff during a beam contour variation.
Target Es/No	Target Es/No is calculated from maximum MODCOD and will remain constant unless changed.
Last Es/No Received	This most recent reported value may change depending on link conditions.
Current DPC Delta	This represents the Adaptive Control Loop (ACL) change in power compared to the set reference, which can increase to margin or terminal maximum power. Any decrease has the full remaining range down to -40 dBm of modulator's output.
Time since last LQRM	This is the time, in seconds, from the last power report received. Under normal conditions, the status updates every 60 seconds.

### Power Reference

Click **[Set Reference]** to place the system into a calibration mode. Selecting this adjusts the Tx Power to achieve a BER of  $10^{-8}$ , and then stores this value along with the Reference MODCOD and Reference Symbol Rate. You may use these three Power Reference values to calculate an equivalent power for any MODCOD/Data Rate combination.

### 6.3.3.2.3 Configuration | WAN | QoS (Quality of Service)



#### Appendix H. RETURN GROUP QoS (QUALITY OF SERVICE)

Figure 6-20 shows the appearance of this page when QoS is disabled (i.e., use the QoS Control Mode drop-down list, available in the **Add/Change/Delete Group** section of this page, to select **Off**, and then click **[Submit]**).

The top portion of the QoS page provides common functionality for all QoS modes. The bottom portion of this page changes depending on the active QoS Mode. All commonality / differences in page appearance between QoS Modes is noted accordingly.



**Comtech EF Data strongly recommends that you do NOT operate the ODM-840 with QoS Control Mode = Off. When QoS Control Mode = Off there is no traffic shaping or filtering. All data coming into the modem will be sent to the WAN as it is received, in the order it was received, for so long as the WAN can support the packet/frame and data rate of the incoming traffic. If there is not enough WAN capacity to support the incoming traffic, packets or frames are tail-dropped as they overflow the internal buffer.**

The screenshot shows the configuration page for QoS. The navigation menu includes Home, Admin, Configuration, Status, and Utility. Under Configuration, there are sub-menus for Interface, WAN, Network, ECM, dSCPC, MEO, Demod, Mod, QoS, Label, Compression, BUC, and LNB. A link to the QoS Statistics page is visible. The main content area is divided into three sections:

- Add/Change/Delete Group:** A table with columns for Index, Name, CIR (kbps), MIR (kbps), and Mode. The current entry is Index 1, Name 'Default Group', CIR 0, MIR Maximum, and Mode Off. There are 'Add', 'Change', and 'Delete' buttons for each row.
- Group Table:** A summary table with columns for Index, Name, CIR (kbps), MIR (kbps), Mode, and Select. It shows the same entry as the table above.
- Add/Delete Per Group Attribute:** A section with radio buttons for VLAN and Subnet (selected), an 'Add' button, and a 'Delete' button with a field for the index to be deleted.

Below the main content area, a status box indicates **QoS Mode is Off**.

Figure 6-20. Configuration | WAN | QoS Page (QoS Control Mode = Off)

### 6.3.3.2.3.1 Page Functionality Common for all QoS Control Modes



The page content that follows is available in all QoS Modes.

You may click the [\(to QoS Statistic page\)](#) hyperlink, located at the top of the page, to view operational statistics on the **Status | Statistics | QoS** page (**Sect. 6.3.4.1.4**).

#### Add/Change/Delete Group

Use the top row text boxes, drop-down lists, and action button to **Add** (create) a QoS Group. The middle row allows you to **Change** (edit) the currently selected group. The bottom row allows you to **Delete** any available group other than the Default Group.

- **Add a group** – Use the top row text boxes to create and add a group. Click **[Add]** to create the rule. From left to right (where applicable):

Column	Description
Index	This is the internal index number for the group. This number increments or decrements automatically as you add or delete groups.
Name	This is the name assigned to the group. The name you create must be 20 characters or less, and it must be unique across all groups.
CIR (kbps)	This is the Committed Information Rate for the group. The QoS Manager will try to guarantee this data rate for all traffic that matches this group.
MIR (kbps)	This is the Maximum Information Rate for the group. The QoS Manager will not allow traffic that matches this group to send more than this data rate.
Mode	When adding a new group or modifying an existing group, use the drop-down list to select a QoS Mode of operation: <ul style="list-style-type: none"> <li>• <b>Off</b> – This mode disables QoS. With QoS Control Mode = Off, the “Per Group” add/deleted/edit tables sections of this page are replaced with the message “QoS Mode is Off.”</li> <li>• <b>DiffServ</b> – This mode allows the ODM-840 to operate in Differentiated Services Mode to make it fully compliant to the Differentiated Services QoS RFC (Request For Comments) standards.</li> <li>• <b>Max/Pri</b> – This mode provides multi-level traffic prioritization with the ability to limit maximum traffic per priority class.</li> <li>• <b>Min/Max</b> – This mode provides a Committed Information Rate (CIR) to each user-defined class of traffic with the ability to allow a higher burstable rate depending on availability.</li> <li>• <b>Pri-Weighted</b> – Weighting is used to drain traffic having the same Priority Level.</li> </ul>

- **Change (modify) an existing group** – Use the middle row text boxes to make changes to the active Index (group). Click **[Change]** to save. The Group Table will update accordingly.
- **Delete an existing group** – Use the bottom row text box to enter an Index (group) number. Click **[Delete]**. Upon deletion, the table index automatically decrements to the next available number.

**About the Default Group** – This group will always exist and cannot be removed. The Default (QoS) Group has the following characteristics:

- The Default Group is always serviced after the CIR and MIR for user-defined QoS groups have been serviced (i.e., what is left over). The Default Group should not be used to reserve bandwidth.
- The CIR for the Default Group is forced to 0kbps.
- The MIR for the Default Group is forced to the Maximum.
- If a packet does not match one of the user-defined subnets associated with a QoS Group, the packet will be put into the Default Group.
- The Default Group contains all of the discovered Remote Sites. This means that if a matching Subnet is not found for a User-defined QoS Group, the Default (QoS) Group will be used and Outbound ACM will function as expected.

## Group Table

Group Table					
Index	Name	CIR (kbps)	MIR (kbps)	Mode	Select
1	Default Group	0	Maximum	Off	<input checked="" type="radio"/>

This table displays the active QoS groups. See the table under “**Add/Change/Delete Group**” for detailed descriptions for each column. When more than one group is available, click **Select** to set that group as the active operational configuration. The page refreshes automatically. If only a single group exists, the page appearance defaults to display that group in all tables.

## Add/Delete Per Group Attribute

**Add/Delete Per Group Attribute**

VLAN  Subnet

Add:

Delete:  (Index to be deleted)

---

**Subnet Attributes**

Index	Type	Value
1	Subnet	90.127.1.0/24



**The VLAN attribute is available only in Bridge Point-to-Multipoint (BPM) Mode, a feature that is available only with the CDM-840 Remote Router. Therefore, you cannot use the VLAN attribute with the ODM-840 to match packets to a QoS Group.**

When more than one group is created, use the controls in this section to select and configure a Subnet attribute. Click **Subnet** to configure a subnet assigned to the group. All traffic within the configured subnet will be routed through this QoS Group. If the QoS Group subnets should overlap, then the first QoS Group will be used for traffic.

To manage attributes:

- **Add an attribute** – Use the top row text boxes to enter the Subnet attribute (Subnet IP/Mask). Click **[Add]** to create the attribute.
- **Delete an existing attribute** – Enter an Index (attribute) number in the text box. Click **[Delete]** to execute removal of that attribute. The Attributes table will update accordingly.

Note the following:

Column	Description
Index	This is the internal index number for the attribute. This number increments or decrements automatically as you add or delete attributes.
Type	<b>Subnet</b> is the only available attribute.
Value	This is the assigned subnet, in xxx.xxx.xxx.xxx/yy format.

The Attributes table entries are displayed based on which traffic has matched to this QoS Group. The user-defined subnets entered into the QoS page need to be equal to or a superset of any of the routes from the remotes – i.e., there must be no overlaps.

The examples that follow illustrate how the locally attached subnets associated with each Ethernet will be reported as routes, unless the Management/Traffic IP address has not been changed; in which case, it will ignore that value.

Example #1	
QoS Subnet	10.1.1.0/24
Remote Management IP Address	192.168.1.1
Remote's Reported Routes	10.1.1.0/27
Result	Remote 192.168.1.1 will be added when traffic to that remote is sent through the CTOG-250

Example #2	
QoS Subnet	10.1.0.0/16
Remote 1 Management IP Address	192.168.1.1
Remote 1 Reported Routes	10.1.1.0/27
Remote 2 Management IP Address	192.168.2.1
Remote 2 Reported Routes	10.1.2.0/24
Result	Remote 192.168.1.1 and 192.168.2.1 will be added

Example #3	
QoS Subnet	10.1.2.0/24
Remote 1 Management IP Address	192.168.1.1
Remote 1 Reported Routes	10.1.2.0/23
Result	Remote 192.168.1.1 will NOT be added because the 10.1.2.0/23 route is not completely "covered" by the QoS Subnet.

### 6.3.3.2.3.2 Page Functionality Specific to Active QoS Mode

#### DiffServ (Differentiated Services) Rules Table





This table is accessible only when QoS Control Mode = DiffServ.

Index	Priority	Per-Hop Behavior (PHB)	Codepoint (DSCP)	Service Rate (Kbps)	Low Drop Precedence (%full) xx=01	Med. Drop Precedence (%full) xx=10	High Drop Precedence (%full) xx=11
1	1	Class Selector 7	111000	N/A	N/A	N/A	N/A
2	2	Class Selector 6	110000	N/A	N/A	N/A	N/A
3	3	Expedited Forwarding	101110	N/A	N/A	N/A	N/A
4	3	Class Selector 5	101000	N/A	N/A	N/A	N/A
5	4	Class Selector 4	100000	N/A	N/A	N/A	N/A
6	5	Class Selector 3	011000	N/A	N/A	N/A	N/A
7	6	Class Selector 2	010000	N/A	N/A	N/A	N/A
8	7	Class Selector 1	001000	N/A	N/A	N/A	N/A
9	8	Assured Forwarding Class 4	100xx0	<input type="text" value="0"/>	100	<input type="text" value="75"/>	<input type="text" value="50"/>
10	8	Assured Forwarding Class 3	011xx0	<input type="text" value="0"/>	100	<input type="text" value="75"/>	<input type="text" value="50"/>
11	8	Assured Forwarding Class 2	010xx0	<input type="text" value="0"/>	100	<input type="text" value="75"/>	<input type="text" value="50"/>
12	8	Assured Forwarding Class 1	001xx0	<input type="text" value="0"/>	100	<input type="text" value="75"/>	<input type="text" value="50"/>
13	9	Default	000000	N/A	N/A	N/A	N/A

When **QoS Control Mode = DiffServ**, you have the option of configuring attributes for each group (the acceptable ranges for each parameter are shown in brackets).

From left to right:

Column	Description
Index	The automatically assigned specific rule internal index number is identified here.
Priority	IP traffic is prioritized based upon the DSCP (DiffServ Code Points) Class Selector Precedence.
Per-Hop Behavior (PHB)	This is the traffic class that determines how packets will be forwarded.
Codepoint (DSCP)	This is the Codepoint value in the Type of Service (ToS) byte of the IP header.
Service Rate (kbps)	The minimum bandwidth is served first among the Assured Forwarding (ASFD) classes in case of bandwidth availability, once Class Selector 7 through Class Selected 1 have been serviced.

Column	Description
Drop Precedences	<p>ASFD Class 4 through 1 Code Points (b100xx0, b011xx0, b010xx0, and b001xx0) carry the drop precedence value (xx). In case of network congestion, a Weighted Random Early Detection (WRED) congestion avoidance algorithm is imposed on these queues to drop the packets randomly rather than 'tail drop.'</p> <p> The ASFD classes all take Priority 8 instead of their corresponding class priorities (i.e., 1 through 4) to provide "Service Rate (kbps)" among all ASFD classes.</p> <ul style="list-style-type: none"> <li>• <b>Low Drop Precedence (% full) [100]</b> – In case of congestion, the WRED is applied after the queue depth exceeds the configured percentage value assigned for the Drop Precedence value b001.</li> <li>• <b>Med. Drop Precedence (%full) [20-90]</b> – In case of congestion, the WRED is applied after the queue depth exceeds the configured percentage value assigned for the Drop Precedence value b010.</li> <li>• <b>High Drop Precedence (% full)) [10-80]</b> – In case of congestion, the WRED is applied after the queue depth exceeds the configured percentage value assigned for the Drop Precedence value b011.</li> </ul> <p> Make sure that: High Drop Precedence value &lt; Med. Drop value &lt; Low Drop value.</p>

Click **[Submit]** to save.



The page sections that follow are accessible only when QoS Control Mode = Max/Pri, Min/Max, or Pri-Weighted.

### Add/Delete Per Group QoS Rule

The appearance of this table varies depending on your active QoS Control Mode. Examples are as follows:

**When QoS Control Mode = Max/Pri:**

Add/Delete Per Group QoS Rule

Name	VLAN Min	VLAN Max	TOS	Application	Src IP/Msk	Dst IP/Msk	Min Src Port	Max Src Port	Min Dst Port	Max Dst Port	Min Bw	Max Bw	Priority	WRED	Filter All	
New Rule	0	0	255	UDP	0.0.0.0/0	0.0.0.0/0	0	65535	0	65535	99999	1	Enable	Disable	Add Rule	
															Enter Rule Index to Delete	Delete Rule

**When QoS Control Mode = Min/Max:**

Add/Delete Per Group QoS Rule

Name	VLAN Min	VLAN Max	TOS	Application	Src IP/Msk	Dst IP/Msk	Min Src Port	Max Src Port	Min Dst Port	Max Dst Port	Min Bw	Max Bw	WRED	Filter All		
New Rule	0	0	255	UDP	0.0.0.0/0	0.0.0.0/0	0	65535	0	65535	99999	Enable	Disable	Add Rule		
															Enter Rule Index to Delete	Delete Rule



**When QoS Control Mode = Pri-Weighted:**

Add/Delete Per Group QoS Rule																	
Name	VLAN Min	VLAN Max	TOS	Application	Src IP/Msk	Dst IP/Msk	Min Src Port	Max Src Port	Min Dst Port	Max Dst Port	Priority	Weight	Min Bw	Max Bw	WRED	Filter All	
New Rule	0	0	255	UDP	0.0.0.0	0.0.0.0	0	65535	0	65535	1	1	0	99999	Enable	Disable	Add Rule
																Enter Rule Index to Delete	Delete Rule

- **Add a Rule** – Enter your desired parameters as needed, and click **[Add Rule]** to add the rule to the Per Group QoS Rule table. Upon entry, the table index automatically increments to the next available number. Note the following (from left to right):

Column	Description
Name	This is the name assigned to the group rule. The name you create must be 20 characters or less, and it must be unique across all groups.
VLAN Min	NOT AVAILABLE. The VLAN attribute is available only in Bridge Point-to-Multipoint (BPM) Mode, a feature that is available only with the CDM-840 Remote Router. Therefore, you cannot use the VLAN attribute with the ODM-840 to match packets to a QoS Group.
VLAN Max	
TOS	Type Of Service bits include a six-bit Differentiated Services Code Point (DSCP) and a two-bit Explicit Congestion Notification (ECN) field: <ul style="list-style-type: none"> <li>• Enter an explicit Code Point match.</li> <li>• Enter the wildcard entry of 255 so that all values trigger true.</li> </ul>
Application	Use the drop-down list to select the application as <b>UDP, TCP, ICMP, RTP, RTP-VOICE, RTP-VIDEO, RTPS, FTP, HTTP, TELNET, SMTP, SNMP, or All-IP.</b>
Src IP/Msk	Enter a Source IP Address/Mask in the form XXX.XXX.XXX.XXX/YY.
Dst IP/Msk	Enter a Destination IP Address/Mask in the form XXX.XXX.XXX.XXX/YY.
Min Src Port	<b>You should specify the Min / Max Source / Destination Ports only if you are aware of the port usage of the desired protocol or application.</b> There are well-known ports for various protocols, but often only the 'command' messaging is transacted on these ports and the 'data' is transferred through a negotiated port.
Max Src Port	
Min Dst Port	
Max Dst Port	
Priority	<b>(Max/Pri and Pri-Weighted modes only)</b> Use the drop-down list to assign a Priority Level from 1 to 8 for each flow: <ul style="list-style-type: none"> <li>• The IP Module classifies each packet that is to be forwarded over the satellite; the packet then has a Priority assigned according to the defined QoS Rules;</li> <li>• Any latency critical traffic such as VoIP/RTP should always be assigned Priority 1;</li> <li>• Priority 1 packets are forwarded immediately; Priority 2 packets are forwarded as soon as there are no Priority 1 packets in the Queue; and so on;</li> <li>• Any packet that does not meet a QoS Rule is assigned to the Default Rule and is assigned a Priority of 9.</li> </ul>
Weight	<b>(Pri-Weighted mode only)</b> Enter a weight from 1 to 9. Weighting is used to drain traffic having the same Priority Level ("Max/Pri" mode) after the minimum bandwidth is met ("Min BW"). The larger the number, the higher the weight.
Min BW	<b>(Min/Max and Pri-Weighted modes only)</b> Assign a value to limit the flow to this minimum utilized bandwidth; otherwise, you may select the default of no bandwidth restriction.
Max BW	Assign a value to limit the flow to this maximum utilized bandwidth; otherwise, you may select the default of no bandwidth restriction.
WRED	Use the drop-down list to <b>Disable</b> or <b>Enable</b> Weighted Random Early Detection.
Filter All	QoS allows flows to be 'filtered' on a per-rule basis so that traffic that you do not want to forward over a satellite link is discarded. Use the drop-down list to <b>Disable</b> or <b>Enable</b> filtering.

- **Delete a group** – Enter the **Rule Index to Delete** in the text box, and then click [**Delete Rule**]. Upon deletion, the table index automatically decrements to the next available number.

### QoS Rules Per Group Table (Edit)

This read-only table displays all *existing* QoS Rules. As each rule is added or deleted, the QoS Rules Per Group Table (Edit) Index Number (#) automatically increments or decrements to the next available number.

The appearance of this table varies depending on your active QoS Control Mode. Examples are as follows:

#### When QoS Control Mode = Max/Pri:

QoS Rules Per Group Table (Edit)

#	Name	VLAN Min	VLAN Max	TOS	Application	Src IP/Msk	Dst IP/Msk	Min Src Port	Max Src Port	Min Dst Port	Max Dst Port	Max Bw	Priority	WRED	Filter All
1	Default	0	0	255	All	0.0.0.0/0	0.0.0.0/0	0	65535	0	65535	170000	8	0	0

#### When QoS Control Mode = Min/Max:

QoS Rules Per Group Table (Edit)

#	Name	VLAN Min	VLAN Max	TOS	Application	Src IP/Msk	Dst IP/Msk	Min Src Port	Max Src Port	Min Dst Port	Max Dst Port	Min Bw	Max Bw	WRED	Filter All
1	Default	0	0	255	All	0.0.0.0/0	0.0.0.0/0	0	65535	0	65535	0	170000	0	0

#### When QoS Control Mode = Pri-Weighted:

QoS Rules Per Group Table (Edit)

#	Name	VLAN Min	VLAN Max	TOS	Application	Src IP/Msk	Dst IP/Msk	Min Src Port	Max Src Port	Min Dst Port	Max Dst Port	Priority	Weight	Min Bw	Max Bw	WRED	Filter All
1	Default	0	0	255	All	0.0.0.0/0	0.0.0.0/0	0	65535	0	65535	8	1	0	0	0	0

See “Add/Delete Per Group QoS Rule” for detailed descriptions for each column.

### 6.3.3.2.4 Configuration | WAN | Label

Use this page to assign up to four Generic Stream Encapsulation (GSE) WAN labels.

Home Admin Configuration Status Utility  
Interface WAN Network ECM dSCPC MEO  
Demod Mod QoS Label Compression BUC LNB

Receive WAN Labels

Label 1

\* When using CDRP, Label Entry 1 will be used and it must be unique across all CDM-840s attached to the same CTOG-250/CDM-800

Label 2

Label 3

Label 4

(A WAN Label must match desired WAN route from the CDM-800)

Submit

Figure 6-21. Configuration | WAN | Label Page

#### Receive WAN Labels

Edit the **Label 1** through **Label 4** text boxes to suit. Each label has a valid range of 1 to 2047.



The assigned Receive WAN Labels must match the WAN Labels assigned on the CTOG-250 Route Table. Note that the preferred method of operation (as required for ACM/VCM Operation) is to first configure a unique WAN Label in Entry #1 for each ODM-840 across the network, and then enable CDRP on the CTOG-250. The associated Route to WAN Label will be automatically updated and maintained.

Click **[Submit]** to save.

### 6.3.3.2.5 Configuration | WAN | Compression

Use this page to configure the Payload and Header Compression feature, if enabled.

**Figure 6-22. Configuration | WAN | Compression Page**

Click the [\(Link to Compression Statistic page\)](#) hyperlink to access the **Status | Statistics | Compression** page (Sect. 6.3.4.1.3).

#### Refresh

Enter each refresh rate, from **1** to **600** packets or **1** second (whichever comes first). *From left to right:*

Feature	Description
Header Compression for UDP	User Datagram Protocol refresh rate
Header Compression for RTP	Real Time Protocol refresh rate
Header Compression for all others	Default protocol refresh rate
Payload Compression	Payload Compression refresh rate

Set the desired rates. Click **[Submit]** to save.



**The ODM-840 always operates in Router Mode. The Bridge Point-to-Multipoint (BPM) Mode Configuration section of this page is non-functional with the ODM-840. BPM, a feature available with the CDM-840 Remote Router, is not available with the ODM-840.**

**Use the 'Configuration | Network | Routing | Routes' page (Sect. 6.3.3.3.1.1) to configure compression settings in Router Mode.**

### 6.3.3.2.6 Configuration | WAN | BUC (Block Up Converter)



This page is operational only when an optional **BLOCK UP CONVERTER** is installed.

Use this page to configure BUC parameters, and to display the BUC status for L-Band operation.

(BUC Power Supply Not Installed)

**BUC Control**

BUC Power Supply

BUC 10 MHz Reference Enable

BUC Low Current Limit  mA (0-4000)

BUC High Current Limit  mA (0-4000)

BUC FSK Communication

BUC FSK Address

BUC RF Output

\*BUC Attenuation  dB (0-30.00) in steps of 0.25

\* Requires Comtech Advanced FSK

**BUC Status**

BUC Power Supply: BUC Power Supply Not Installed  
BUC Voltage: 0 V  
BUC Current: 0 mA

BUC Temperature: 0 C  
BUC PLL: Not Connected  
BUC Power Level: 0 W  
0 dBm  
BUC Software Version: 0

Figure 6-23. Configuration | WAN | BUC Page

#### BUC Control

The valid operating range for each item in this section is noted in parentheses.

- **BUC Power Supply** – Use the drop-down list to select the BUC Power Supply as **Off** or **On**.
- **BUC 10 MHz Reference Enable** – Use the drop-down list to select the BUC 10 MHz Reference Enable as **Off** or **On**.
- **BUC Low or High Current Limit** (0 to 4000) – Enter the BUC current alarm for either limit in 100mA increments.
- **BUC FSK Communication** – Use the drop-down list to select BUC Phase Shift Keying as **Off**, **Basic Only**, or **Basic + Advanced**.
- **BUC FSK Address** – Use the drop-down lists to select and address from **1** to **15**.
- **BUC Attenuation** (use of this feature requires Comtech Advanced FSK) – Enter a value, in 0.25 dB steps, from **0** to **30**.

Click **[Submit BUC Control]** to save.

## **BUC Status**

When the presence of BUC Power Supply is detected, it is acknowledged here and its voltage and current information is continuously monitored and is provided on a *read-only* basis:

- **BUC Power Supply**
- **BUC Voltage (V)**
- **BUC Current (mA)**
- **BUC Temperature (degrees Celsius)**
- **BUC PLL (Phase Lock Loop)**
- **BUC Power Level (W / dBm)**
- **BUC Software Version**

Click **[Refresh]** to update this section with its latest available statistics.

### 6.3.3.2.7 Configuration | WAN | LNB (Low Noise Block Down Converter)



This page is operational only when an optional **LOW-NOISE BLOCK DOWN CONVERTER** is installed.

Use this page to configure LNB parameters, and to display the LNB status for L-Band operation.

The screenshot shows a web interface for configuring LNB parameters. The navigation bar includes 'Home', 'Admin', 'Configuration', 'Status', and 'Utility'. The 'Configuration' section is active, with sub-tabs for 'Interface', 'WAN', 'Network', 'ECM', 'dSCPC', and 'MEO'. Under 'WAN', there are sub-tabs for 'Demod', 'Mod', 'QoS', 'Label', 'Compression', 'BUC', and 'LNB'. The 'LNB Control' section contains the following controls: 'LNB DC Power' (set to 'Off'), 'LNB Reference Enable' (set to 'Disable'), 'LNB Current Threshold Low' (set to '0' mA), and 'LNB Current Threshold High' (set to '500' mA). A 'Submit LNB Controls' button is located below these controls. The 'LNB Status' section displays 'LNB Voltage: 0 V' and 'LNB Current: 0 mA', with a 'Refresh' button below.

Figure 6-24. Configuration | WAN | LNB Page

#### LNB Control

The valid operating range for each item in this section is noted in parentheses.

- **LNB DC Power** – Use the drop-down list to select the power as **Off**, **13V**, **18V**, or **24V**.
- **LNB Reference Enable** – Use the drop-down list to **Enable** or **Disable** the LNB Reference.
- **LNB Current Threshold (Low and High)** (0 to 500) – Enter a value, in mA, for either function.

Click **[Submit LNB Controls]** to save.

#### LNB Status

This *read-only* section provides the **LNB Current (mA)** and **LNB Voltage (V)** information.

Click **[Refresh]** to update this section with its latest available statistics.

### 6.3.3.3 Configuration | Network Pages

Use the **Network** pages to configure network-based operating parameters. Click the **Routing**, **ARP**, **Working Mode**, or **DNS** tab to continue.

#### 6.3.3.3.1 Configuration | Network | Routing Pages

Click the **Routes**, **IGMP**, or **DHCP** tab to continue.

##### 6.3.3.3.1.1 Configuration | Network | Routing | Routes

Use this page to enter static routes for IP traffic over the satellite or to another device on the local LAN.

**Add New Route**

Index	Description	Dest. IP/Mask	Interf.	Next Hop IP	Header Comp.	Payload Comp.
2			To WAN	0.0.0.0	Disabled	Disabled

**Delete Route**

Enter Route Index to Delete

**Route Table (Edit)**

Index	Description	Dest. IP/Mask	Interf.	Next Hop IP	Header Comp.	Payload Comp.	
1	default	0.0.0.0/0	To WAN	N/A	Disabled	Disabled	Change

Figure 6-25. Configuration | Network | Routing | Routes Page

#### Add New Route

Use this section to directly add a route. *From left to right:*

Column	Description
Index	This is the <i>read-only</i> internal index number for the route. This number increments or decrements automatically as you add or delete routes.
Description	This label helps to maintain the network. The name you create must be 20 characters or less, and it must be unique across all routes.
Dest. IP/Mask	Enter a Destination IP Address/Mask in the form XXX.XXX.XXX.XXX/YY.
Intfc.	Use the drop-down list to select the Interface as <b>toWAN</b> or <b>toLAN</b> .
Next Hop IP	Enter the desired Next Hop IP Address for <b>toLAN</b> routes. Note that no Next Hop entry is needed for <b>toWAN</b> routes.
Header Comp.	Use the drop-down list to <b>Disable</b> or <b>Enable</b> Header Compression operation.
Payload Comp.	Use the drop-down list to <b>Disable</b> or <b>Enable</b> Payload Compression operation.



Click **[Add Entry]** when done. The index automatically increments to the next available number when the new route is added.



**When in Router Mode, the ODM-840 will not transmit a multicast address in the Internet control range (224.0.0.0 to 224.0.1.255). It filters the packets.**

## Delete Route

**Enter Route Index to Delete.** Click **[Delete Entry]** to delete the specified route entry from the route table. Upon deletion, the Route Table index number automatically decrements to the next available number.

## Route Table (Edit)

Use the text boxes and drop-down lists to edit all current Route Table entries, as described previously for the **Add New Route** section. Click **[Submit Changes]** to save. The Route Table entries will update accordingly.

### 6.3.3.3.1.2 Configuration | Network | Routing | IGMP

IGMP (Internet Group Management Protocol), when enabled, responds to IGMP queries for the configured multicast routes on the transmit side and generates IGMP queries on the receive side. If there are no active IGMP receivers on the LAN, it stops forwarding the multicast traffic (received from the satellite) to the LAN.

Use this page to enable IGMP for configured multicast routes.

Note: When the working mode is set to BPM, the IGMP configuration only applies to the Management Port

**IGMP**

WAN to traffic port multicast traffic:

If "Use IGMP" is selected, groups need to be joined to pass traffic

**IGMP Configuration**

Version:

Last Member Query Interval:  sec (1-25)

Query Interval:  sec (1-60)

Query Response Interval:  sec (1-25)

**IGMP Table**

Index	Mult-group IP	Mult-Source IP	Mult. Pkts	Downstream Interface
1	239.255.255.250	192.168.1.2	9	GE

Figure 6-26. Configuration | Network | Routing | IGMP Page

#### IGMP

WAN to traffic port multicast traffic – Use the drop-down list to set operation as Use **IGMP** or **Forward All Multicast**.

#### IGMP Configuration

The valid operating ranges are provided in this section in parentheses, where applicable.

- **Version** – Use the drop-down list to select **IGMPv1**, **IGMPv2**, or **IGMPv3**.
- **Last Member Query Interval** (1 to 25) – Enter a value, in seconds. The default is **1** second. This is the maximum response time inserted into group-specific queries that are set in response to Leave Group messages, and is also amount of time between group-specific query messages. This value may be tuned to modify the "leave latency" of the network; a reduced value results in reduced time to detect the loss of the last member of a group.
- **Query Interval** (1 to 60) – Enter a value, in seconds. The default is **1** second. This is the interval between general queries sent by the unit. By varying the query interval, the

administrator may tune the number of IGMP messages on the subnet; note that larger numbers cause the IGMP queries to be sent less often.

- **Query Response Interval** (1 to 25) – This is the maximum response time inserted into the periodic general queries. By varying the Query Response Interval, the administrator may tune the “burstiness” of IGMP messages on the subnet; note that larger values make the traffic less “bursty” as host responses are spread out over a large interval.



**The number of seconds assigned to the Query Response Interval must be less than the Query Interval.**

Click **[Submit]** to save.

## IGMP Table

This *read-only* table lists the IGMP Groups that are active on the unit. This allows you to determine which services are being used and the minimum time before a service will be terminated.

Click **[Refresh]** to update this section with its latest available statistics.

### 6.3.3.3.1.3 Configuration | Network | Routing | DHCP

**DHCP** (Dynamic Host Configuration Protocol) allows a device to be configured automatically, eliminating the need for intervention by a network administrator, and provides a server located at the hub for keeping track of devices that have been connected to the network. This prevents two devices from accidentally being configured with the same IP Address.

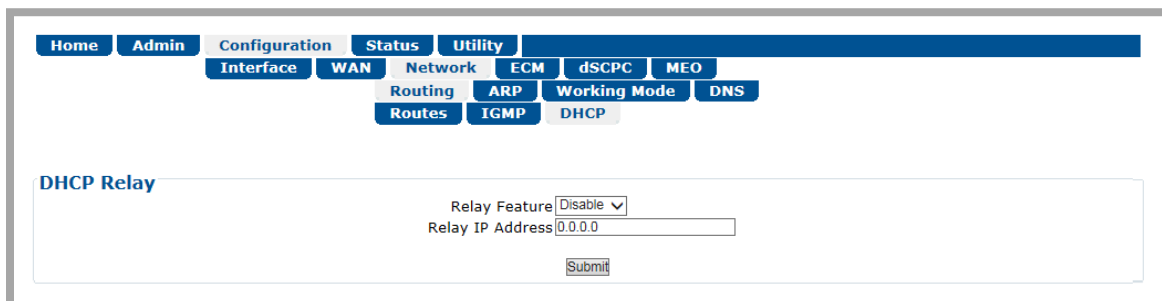

**Figure 6-27. Configuration | Network | Routing | DHCP Page**

#### **DHCP Relay**

The ODM-840 DHCP Relay feature allows the operator to deploy a single DHCP server at the hub that manages all of the devices throughout the operator's remote networks. When a device on the ODM-840 network issues a DHCP request, it is relayed to the DHCP server as specified by the "Relay IP Address". The DHCP response is then sent directly to the requesting device.

- **Relay Feature** – Use the drop-down list to select the DHCP Relay feature as **Enable** or **Disable**.
- **Relay IP Address** – Specify the IP Address to be used for the DHCP server at the hub in the form XXX.XXX.XXX.XXX.

Click **[Submit]** to save.

### 6.3.3.3.2 Configuration | Network | ARP

Use this page to configure the ODM-840 ARP (Address Resolution Protocol) parameters.

**Add Static ARP**

Index	IP	MAC
2	<input type="text"/>	<input type="text"/>

[Add Entry](#)

**Delete Static ARP**

Enter Entry Index to Delete

[Delete Entry](#)

**Flush Dynamic ARP**

Warning! Click on this will flush all Dynamic ARP entries

[Flush ARP Table](#)

**ARP Table (Edit)**

Index	IP	MAC	Type
1	192.168.1.2	90:e2:ba:2b:a6:bb	Dynamic

[Submit Changes](#)

Figure 6-28. Configuration | ARP Page

#### Add Static ARP

Enter the desired **IP** and **MAC** addresses. Click **[Add Entry]** when done. The **Index** column automatically increments to the next available number when the specified static ARP entry is added to the **ARP Table**.



Comtech EF Data recommends that you do not add Static ARP entries. Dynamic ARPs should function as expected under normal operation. You should use Static ARP entries only when it has been demonstrated that a connected networking device does not respond to ARP as expected.

#### Delete Static ARP

**Enter the Entry Index to Delete.** Click **[Delete Entry]** to delete the specified entry index from the **ARP Table**. Upon deletion, the ARP Table index number automatically decrements to the next available number.

#### Flush Dynamic ARP

Click **[Flush Dynamic ARP]** to delete all dynamically-learned ARP entries.

#### ARP Table (Edit)

This section displays all current Static and Dynamic ARP entries, and allows to user to directly edit the current Static ARP entries. *From left to right:*

Column	Description
Index	This is the <i>read-only</i> internal index number for the ARP entry. This number increments or decrements automatically as you add or delete entries.
IP	Entry IP Address, format XXX.XXX.XXX.XXX.
MAC	Entry MAC Address, format YY:YY:YY:YY:YY.
Type	The <i>read-only</i> entry Type is listed here as <b>Static</b> or <b>Dynamic</b> and cannot be edited.

Click **[Submit Changes]** to save.

### 6.3.3.3 Configuration | Network | Working Mode



The ODM-840 always operates in Router Mode. In Router Mode, the traffic ports of the CTOG-250, CDD-880, and ODM-840 are configured to function as a Router.

BPM (Bridge Point-to-Multipoint) Mode, a feature available with the CDM-840 Remote Router, is not available with the ODM-840.

Click the “[\(Link to GE Interface Configuration Page\)](#)” hyperlink to access the ‘Configuration | Interface | Mgt/Traffic’ page (Sect. 6.3.3.1.1).

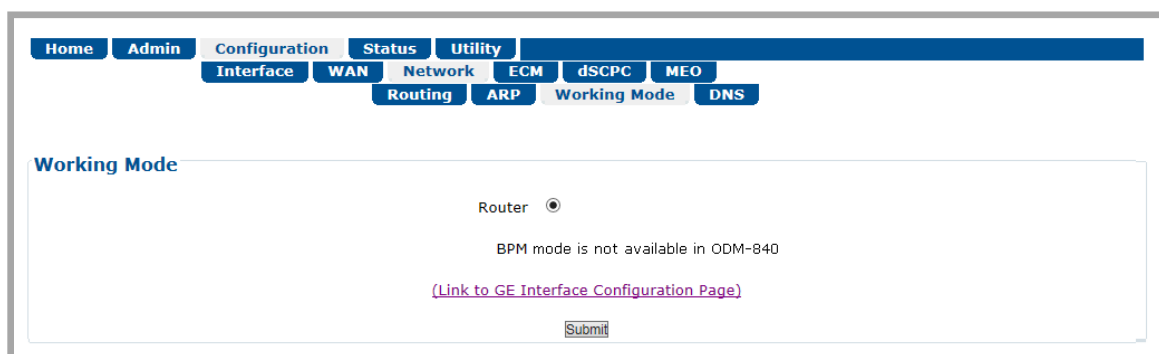

**Figure 6-29. Configuration | Network | Working Mode Page**

### 6.3.3.3.4 Configuration | Network | DNS

DNS (Domain Name System) caching speeds up Internet access by eliminating subsequent queries over the satellite link. Use this page to manage DNS caching.

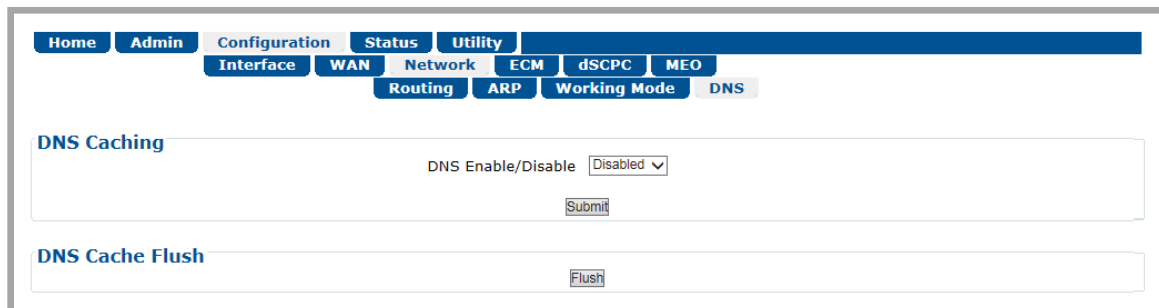

**Figure 6-30. Configuration | Network | DNS Page**

Note the following:

- When the ODM-840 receives a DNS query at one of its Ethernet ports, a DNS cache lookup is performed in the local DNS cache. If the entry is found, a DNS response message is immediately returned to the requesting entity with a time-to-live value of 10 seconds. If no match is found, the request packet is forwarded to the Hub.
- When a DNS response packet is received from the Hub, a check is made to see if the entry already exists in the cache. If it exists, the time-to-live for the entry is reset to 900 seconds (15 minutes). If it is a new entry, it is added to the cache with time-to-live set to 900 seconds (15 minutes).
- The local DNS cache is periodically cleaned by removing expired entries.

#### DNS Caching

Use the drop-down list to set DNS Caching as **Disabled** or **Enabled**.

Click **[Submit]** to save.

#### DNS Cache Flush

Click **[Flush]** to clear the DNS Cache of all data.

### 6.3.3.4 Configuration | ECM (Entry Channel Mode)



1) The Configuration | ECM page is operational only when the optional VIPERSAT MANAGEMENT SYSTEM (VMS) is installed and enabled.

2) ECM uses Demod 1 of the CDD-880 as the ALOHA channel.



- Appendix F. ECM (ENTRY CHANNEL MODE)
- Appendix G. ENTRY CHANNEL MODE SWITCHING in the adjunct CEFD publication VMS v3.x.x VIPERSAT Management System User Guide (CEFD P/N MN/22156)

ECM (Entry Channel Mode) provides a method for remotes requiring dSCPC access channels to either enter the network initially or re-enter the network after a power or service outage. Use this page to configure ECM.

The screenshot shows the 'Configuration | ECM' page with the following sections:

- ECM Remote Configuration:**
  - Mode: Disabled (dropdown)
  - Note: In order to take control from VMS, please disable ECM
  - Submit button
  - Multicast IP: 239.1.2.5 (text input)
  - Group ID: 255 (text input)
  - Power Hunt Enable: Disable (dropdown)
  - Rx LO Frequency: 0 MHz (text input)
  - Tx LO Frequency: 0 MHz (text input)
  - ECM Power: 0.0 (text input)
  - Submit button
- ECM Remote Status:**
  - Cycle Length: 0 msec
  - Aloha State: Idle
  - Current Tap: 0
  - Home State Revert Timer: 0 seconds
  - Time in ECM: 0 seconds
  - Seconds Until Next Probe: 0 seconds
- ECM Tx Statistics:**
  - Total Count: 0
  - Successes: 0
  - Failures: 0
  - No Detect: 0
  - Last Status: No Detect
  - Seconds since last xmit: 0 days 2 hours 19 minutes 7 seconds

Figure 6-31. Configuration | ECM Page

#### ECM Remote Configuration

- **Mode** – Use the drop-down list to select operation as **Disabled**, **Offline**, **Wait**, or **Online**:

Selection	Description
Disabled	This <i>disables</i> ECM operation.
Offline	The remote will not transmit and remains in this standby mode until a new state is selected, either locally or from the VMS. Application examples for this mode include COTM (Communications On The Move) or military maneuvers requiring radio silence conditions.



Selection	Description
Wait	<p>Keeping ODM-840(s) in the ECM channel may result in oversubscription, where some percentage of remotes wait their turn for pooled SCPC resources. The user may choose to selectively control remotes through manual, scheduled, or external switch request commands.</p> <p>By selecting <b>Wait</b>, the ODM-840(s) remain in standby mode, but continue to send status messages to the VMS and to the CTOG-250 Comtech Traffic Optimization Gateway with CDM-800 Gateway Router.</p> <p>In Wait mode, messages directed to the VMS update connected link status, while ACM, CDRP, and traffic data statistics sent to the CTOG-250 (in dynamic routing mode) maintain forward path ACM and routing tables.</p>
Online	<p>The ODM-840 powers up, requests network registration, and switches to dSCPC at its minimum site policy data rate setting. <i>This is the most common mode of operation.</i></p>

Click **[Submit]** to save.

- **Multicast IP** – Enter the IP address for the Multicast of the Transmission Announcement Protocol (TAP) message that is sent out by the CDD-880 Multi Receiver Router to all of the associated ODM-840 or ODM-840 Remote Routers in that group.
- **Group ID** (0 to 255) – Enter the Group ID number for the CDD-880 to which this unit belongs.
- **Power Hunt Enable** – Use the drop-down list to select this function as **Disable** or **Enable**. When enabled, the transmission power control feature for the unit modulator is activated while in Entry Channel Mode (ECM). This function provides compensation during periods of impaired transmission or for instances when the initial (baseline) power value is insufficient, and assists in maintaining return link integrity.
- **Rx LO Frequency** – Assign a value, in MHz, to the Rx LO (Low Oscillator) Frequency.
- **Tx LO Frequency** – Assign a value, in MHz, to the Tx LO (Low Oscillator) Frequency.
- **ECM Power** (-40.0 to 0.0) – Enter the power level, in dBm, for transmission of the Aloha ECM signal. This level was determined for this unit when its terminal was commissioned, and must be calibrated with the satellite provider.

Click **[Submit]** to save.

## ECM Remote Status

This section provides the following *read-only* information:

- **Cycle Length** – The Cycle Length is the total length of time, in milliseconds, between the start of a transmission and the completion of the transmission cycle (TAP) transmitted by the CDD-880 to the ODM-840 or ODM-840 Remote Routers in the ECM group. It is the product of the number of slots and the slot length (consisting of the preamble, data slot size, and guard band).

- **Aloha State** – The Aloha State indicates the current state of this unit during the ECM cycle:

Unit State	Description
Idle	Unit is not transmitting; either inactive or waiting for switching assignment.
Active	Unit is actively transmitting (probing) to the Hub for either registration or request for switching to dSCPC.
Switched	Remote has successfully switched from ECM to dSCPC.

- **Current Tap** – Indicates current value of sequential progression of TAP message transmission. Ranges from 0 to 255, then repeats.
- **Current Slot** – The time slot number that has been assigned to this unit in the transmission cycle for switching from ECM to dSCPC.
- **Home State Revert Timer** – The time, in seconds, that must pass without receiving communications from the HCC (Hub Channel Controller – i.e., Demod #1 on the CDD-880, the designated ECM controller) TAP message before this unit is reverted from dSCPC mode back to ECM to re-establish communications settings for receiving the TAP. *This parameter is set in the VMS.*
- **Probing Duration** – Amount of time, in seconds, that this unit has been transmitting to the HCC to request registration and switchout.
- **Seconds Until Next Probe** – The time period, in seconds, before this unit will again transmit to the HCC.

## ECM Tx Statistics

This section provides the following *read-only* information:

Row	Description
Total Count	This is the total number of transmissions since the modem entered Entry Channel Mode.
Successes	This is the number of <u>successful</u> (entire) transmissions <u>received</u> by the hub.
Failures	This is the number of <u>incomplete</u> transmissions that were <u>detected</u> by the hub.
No Detect	This is the number of transmissions that were <u>undetected</u> by the hub
Last Status	This displays the status of the most recent transmission as <b>Success</b> , <b>Failure</b> , or <b>No Detect</b> .
Seconds since last xmit	This is the number of seconds since the last transmission, <u>regardless of status</u> .



**Whenever the modem reverts from dSCPC to ECM, the statistics will clear.**

### 6.3.3.5 Configuration | dSCPC (Dynamic Single Carrier per Channel)



This page is operational only when the optional dSCPC FAST feature and VIPERSAT MANAGEMENT SYSTEM (VMS) is installed and enabled.

Use the optional dSCPC (Dynamic Single Carrier per Channel) FAST feature to enable dynamic allocation and sharing of bandwidth among users.

The screenshot shows the dSCPC configuration page with the following sections:

**Load Switching Configuration**

- Mode: Disabled (dropdown)
- Submit button
- Step Up Threshold (%): (0-100) 95
- Step Down Threshold (%): (0-100) 65
- Step Up Delay (Sec): (10-60) 10
- Step Down Delay (Sec): (10-600) 10
- Excess Capacity (%): (0-100) 10
- Submit button

**ToS Switching Configuration**

- Enable: Disabled (dropdown)
- Max # of Sessions (per TOS Id): 1
- Submit button

Index	Name	ID	Type	SCPC Data Rate	Timeout		
0		0	0	0	0	Change	Delete
1						Add Entry	

Figure 6-32. Configuration | dSCPC Page

#### Load Switching Configuration

The valid operating ranges for items in this section are provided in parentheses.

- **Mode** – Use the drop-down list to select operation as **Disabled** or **Enabled**.

Click **[Submit]** to save.

- **Step Up Threshold** (0 to 100) – Enter the percentage of bandwidth use that will trigger a switch **up** from the present SCPC rate to a **higher** rate to ensure that there is sufficient bandwidth available for current conditions. Note that this value must be **greater** than the value specified for the SCPC *Step Down Threshold*. A typical setting for this parameter is **95%**.
- **Step Down Threshold** (0 to 100) – Enter the percentage of bandwidth use that will trigger a switch **down** from the present SCPC rate to a **lower** rate to ensure efficient bandwidth usage for current conditions. Note that this value must be **less** than the value specified for the SCPC *Step Up Threshold*. A typical setting for this parameter is **65%**.
- **Delay** (1 to 50) – Enter the Switching Delay period, in seconds, to ensure that a premature switch up or down in the SCPC rate does not occur due to a temporary rise or fall in traffic.

- **Excess Capacity** (0 to 100) – Enter the Excess Capacity data rate percentage to be added to the SCPC data rate. This setting makes additional bandwidth available for when demand arises while minimizing Step Up switching events.

## ToS Switching Configuration

- **Enable** – Use the drop-down list to select operation as **Disabled** or **Enabled**.
- **Max # of Sessions (per ToS Id)** (1 to 127) – Allows setting a limit for the number of active sessions for a particular ToS switch type. Note that the overall limit for active sessions in the network is 127.

Click **[Submit]** to save.

## (ToS Rules Table)

*The valid operating range for each item in this section is noted in parentheses. From left to right:*

Column	Description
Index	The automatically-assigned specific rule internal index number is identified here.
Name	(1 to 20 characters) – Enter a text label for circuit identification.
ID	(1 to 63) – Enter an integer value for the ToS ID.
Type	(64 to 254) – Enter an integer value for the Switch Type to inform the VMS what switching policy to use.
SCPC Data Rate	(16 to 16000) Enter the desired data rate, in kbps, for this service type.
Timeout	(0 to 60) Enter the timer setting, in seconds, for restoring the home state condition once data packet flow stops.

- **Change (edit) a ToS Switching Configuration rule** – Edit the information for the specific indexed rule. Click **[Change]**.
- **Delete a ToS Switching Configuration rule** – Click **[Delete]** to delete the specific indexed rule from the ToS Rules Table.
- **Add a ToS Switching Configuration rule** – Enter the information for the new rule. Click **[Add Entry]**. The rule will be assigned to the next incremented index number, with **[Change]** and **[Delete]** functionality assigned to the new entry.

## 6.3.4 Status Pages

The **Status** pages provide status, event logging, and operational statistics windows.

Click the **Statistics** or **Monitor** tab to continue.

### 6.3.4.1 Status | Statistics Pages

Click the **Traffic**, **Network**, **Compression**, **QoS**, **E1**, or **Trending** tab to continue.

#### 6.3.4.1.1 Status | Statistics | Traffic

Use this page to view *read-only*, abridged status windows pertaining to the basic operational statistics for the Ethernet, Modulator, and Demodulator traffic.

The screenshot shows a web interface with the following components:

- Navigation:** Home, Admin, Configuration, Status, Utility, Statistics, Monitor, Traffic, Network, Compression, QoS, E1, Trending.
- Statistics Control:** Clear Eth Stats, Clear Mod Stats, Clear Demod Stats, Clear Drops (QoS Stats), Clear All Stats, Refresh.
- Ethernet Statistics Table:**

Interface	Total Packets Transmitted	Total Packets Received	UC Packets Transmitted	UC Packets Received	MC Packets Transmitted	MC Packets Received	Current Tx Rate (Kbps)	Current Rx Rate (Kbps)	Maximum Tx Rate (Kbps)	Maximum Rx Rate (Kbps)
	16714	16059	16574	14931	140	1128	11	6	3575	336
- Mod Statistics Table:**

Packets Transmitted	UC Packets Transmitted	MC Packets Transmitted	Packets Dropped	Current Tx Rate (pps)	Current Tx Rate (kbps)	Maximum Tx Rate (kbps)	Total Bytes Transmitted
1684	1682	2	0	0	0	0	107776
- Demod Statistics Table:**

Packets Received	UC Packets Received	MC Packets Received	Corrupted Rx Packets	Current Rx Rate (pps)	Current Rx Rate (kbps)	Maximum Rx Rate (kbps)	Pkts Dropped (No HDR Decomp)	Pkts Dropped (No PLD Decomp)
0	0	0	0	0	0	0	0	0

Figure 6-33. Status | Statistics | Traffic Page

### Statistics Control

Click **[Clear Eth Stats]**, **[Clear Mod Stats]**, **[Clear Demod Stats]**, **[Clear Drops (QoS Stats)]**, **[Clear All Stats]**, or **[Refresh]**.

From left to right:

Action Button	Function
[Clear Eth Stats]	Click to clear entries from the Ethernet Statistics table.
[Clear Mod Stats]	Click to clear entries from the Mod Statistics table.
[Clear Demod Stats]	Click to clear entries from the Demod Statistics table.
[Clear Drops (QoS Stats)]	Click to clear the packets dropped in the Mod Statistics table.
[Clear All Stats]	Click to clear entries from <b>all</b> statistics tables on this page.
[Refresh]	Click to update the contents of <b>all</b> tables on this page.

## Ethernet Statistics

*From left to right:*

Column	Description
Interface	This column is not used with the ODM-840.
Total Packets Transmitted	Total number of packets transmitted.
Total Packets Received	Total number of packets received.
UC Packets Transmitted	Unicast packets transmitted.
UC Packets Received	Unicast packets received.
MC Packets Transmitted	Multicast packets transmitted.
MC Packets Received	Multicast packets received.
Current Tx Rate (kbps)	Most recent transmitted data rate (in kilobits per second).
Current Rx Rate (kbps)	Most recently received data rate (in kilobits per second).
Maximum Tx Rate (kbps)	Peak transmitted data rate (in kilobits per second).
Maximum RX Rate (kbps)	Peak received data rate (in kilobits per second).

## Mod Statistics

*From left to right:*

Column	Description
Packets Transmitted	Packets transmitted.
UC Packets Transmitted	Unicast packets transmitted.
MC Packets Transmitted	Multicast packets transmitted.
Packets Dropped	Packets dropped.
Current Tx Rate (pps)	Most recently transmitted symbol rate (in packets per second).
Current Tx Rate (kbps)	Most recently transmitted symbol rate (in kilobits per second).
Maximum Tx Rate (kbps)	Peak transmitted symbol rate (in kilobits per second).
Total Bytes Transmitted	Total number of bytes transmitted.

## Demod Statistics

*From left to right:*

Column	Description
Packets Received	Packets received.
UC Packets Received	Unicast packets received.
MC Packets Received	Multicast packets received.
Corrupted Rx Packets	Packets dropped due to corruption over the WAN.
Current Rx Rate (pps)	Most recently received symbol rate (in packets per second).
Current Rx Rate (kbps)	Most recently received symbol rate (in kilobits per second).
Maximum Rx Rate (kbps)	Peak received symbol rate (in kilobits per second).
Pkts Dropped (No HDR Decomp)	Packets dropped without Header Decompression.
Pkts Dropped (No PLD Decomp)	Packets dropped without Payload Decompression.

### 6.3.4.1.2 Status | Statistics | Network / Router

Use this page to view cumulative traffic information.

The screenshot displays a web interface for network statistics. At the top, there is a navigation menu with tabs: Home, Admin, Configuration, Status, Utility, Statistics, Monitor, Traffic, Network, Compression, QoS, E1, and Trending. The 'Status' tab is selected, and 'Router' is highlighted under the 'Network' sub-tab.

Below the navigation, there is a 'Clear Statistics' section with a 'Clear' button.

The 'Interface Counters' section contains a table with the following data:

Description	LAN(Packets)	WAN(Packets)
Received Packets	16437	0
Transmitted Packets	16899	4

A 'Refresh' button is located below the table.

The 'Router Counters' section contains a table with the following data:

Description	(Packets)
Received Packets	485
Routed Packets	0
IP Header Errors	0
IP Dest Errors	230
No Route Errors	0
Buffer Full Errors	0

A 'Refresh' button is located below the table.

The 'Management Counters' section contains a table with the following data:

Description	(Packets)
Management Received Packets	14139
Management Transmitted Packets	16957

A 'Refresh' button is located below the table.

Figure 6-34. Status | Statistics | Network | Router Page

#### Clear Statistics

Click **[Clear]** to clear all operational statistics from the buffer.

#### Interface / Router / Management Counters

For each section, click **[Refresh]** to update the section with its latest available statistics.

### 6.3.4.1.3 Status | Statistics | Compression



The Tx Header and Payload Compression statistics are functional only when Tx Header and/or Payload Compression are enabled. Use the 'Configuration | WAN | Compression' page (Sect. 6.3.3.2.5) to enable or disable Compression operation.

Use this page to view *read-only* cumulative WAN, Payload Compression, and Header Compression statistics.

([Link to Compression Configuration page](#))

Clear Compression Counters

**WAN Statistics**

WAN Tx Utilization	Total LAN to WAN Bandwidth Savings	Number Header Decompression Packets Dropped (Pkts)	Number Payload Decompression Packets Dropped (Pkts)
0 %	0 %	0	0
<input type="button" value="Refresh"/>			

**Payload Compression Statistics**

Pre Comp Bytes	Post Comp Bytes	Savings	Compression Ratio
0	0	0 %	1.00:1
<input type="button" value="Refresh"/>			

**Header Compression Statistics**

Group Name	Pre Comp Bytes	Post Comp Bytes	Savings	Total Packets	Full Header Packets	Error Packets
Default Group	0	0	0 %	0	0	0
	0	0	0 %	0	0	0
<input type="button" value="Refresh"/>						

**Figure 6-35. Status | Statistics | Compression Page**

Click the ([Link to Compression Configuration page](#)) hyperlink to access the 'Configuration | WAN | Compression page' (Sect. 6.3.3.2.5).

#### Clear Compression Counters

Click **[Clear]** to clear all compression statistics from the buffer.

#### WAN / Payload Compression / Header Compression Statistics

Click **[Refresh]** to update each page section with its latest available statistics.



### 6.3.4.1.4 Status | Statistics | QoS



#### Appendix H. RETURN GROUP QoS (QUALITY OF SERVICE)

The appearance of this page changes depending on the active QoS Control Mode. The top portion of this page provides common functionality for all QoS modes. The bottom portion of this page changes depending on the active QoS Control Mode. All commonality / differences in page appearance between QoS Modes is noted accordingly.

Home
Admin
Configuration
Status
Utility

Statistics
Monitor

Traffic
Network
Compression
QoS
E1
Trending

[\(Link to QoS Configuration page\)](#)

**Statistics Control**

**Total For All Groups**

Tx Packets	Dropped Packets	Tx Packets Rate (pps)	Tx Data Rate (kbps)
0	0	0	0

**Group Table**

Index	Name	Data Rate (kbps)	Dropped Packets	Config. CIR (kbps)	Config. MIR (kbps)	CIR Avail Last 1 Min	CIR Avail Last 15 Min	CIR Avail Last 60 Min	Mode	Select
1	Default Group	0	0	0	160000	100%	100%	100%	Off	<input checked="" type="radio"/>

**QoS Statistics**

Index	Description	Tx Packets	Dropped Packets	Tx Packet Rate (packets/s)	Tx Data Rate (kbps)
1	Default	0	0	0	0
<b>Per Group Total</b>		0	0	0	0

**QoS Statistics**

Priority	Description	Tx Packets	Dropped Packets	Tx Packet Rate (packets/s)	Tx Data Rate (kbps)
1	Class Select 7	0	0	0	0
2	Class Select 6	0	0	0	0
3	Exped Forward	0	0	0	0
3	Class Select 5	0	0	0	0
4	Class Select 4	0	0	0	0
5	Class Select 3	0	0	0	0
6	Class Select 2	0	0	0	0
7	Class Select 1	0	0	0	0
8	Assured Fwd 4	0	0	0	0
8	Assured Fwd 3	0	0	0	0
8	Assured Fwd 2	0	0	0	0
8	Assured Fwd 1	0	0	0	0
9	Default DSCP	0	0	0	0
<b>Per Group Total</b>		0	0	0	0

(TOP) Page with QoS Control Mode = OFF, Max/Pri, Min/Max, or Pri-Weighted  
(BOTTOM) Page QoS Statistics Section with QoS Control Mode = DiffServ

**Figure 6-36. Status | Statistics | QoS Page**

### 6.3.4.1.4.1 Page Functionality Common for all QoS Control Modes



The page content that follows is available in all QoS Modes.

You may click the [\(to QoS Configuration page\)](#) hyperlink, located at the top of the page, to select a different QoS Mode or manage your QoS groups (Sect. 6.3.3.2.3).

#### Statistics Control



- Click **[Clear All Counters]** to clear the statistics buffers of all existing data.
- Click **[Refresh Statistics]** to update the statistics tables with the most recently reported statistics.

#### Total For All Groups

Total For All Groups			
Tx Packets	Dropped Packets	Tx Packets Rate (pps)	Tx Data Rate (kbps)
0	0	0	0

This table provides the cumulative tally of all QoS Groups for the number of Tx Packets, Dropped Packets, Tx Packet Rate, and Tx Data Rate.

#### Group Table

Group Table										
Index	Name	Data Rate (kbps)	Dropped Packets	Config. CIR (kbps)	Config. MIR (kbps)	CIR Avail Last 1 Min	CIR Avail Last 15 Min	CIR Avail Last 60 Min	Mode	Select
1	Default Group	0	0	0	160000	100%	100%	100%	DiffServ	<input checked="" type="radio"/>

This table provides a cumulative tally of the active selected groups. Click **Select** to designate an active group – the row will automatically refresh with the group’s latest compiled operating statistics. From left to right:

Column	Description
Index	This is the internal index number for the group.
Name	This is the unique name assigned to the group.
Data Rate (kbps)	This is the configured operating data rate (in kilobits per second).
Dropped Packets	This is the total number of packets dropped by the group.
Config. CIR (kbps)	This is the Committed Information Rate (in kilobits per second).as configured for the group.
Config. MIR (kbps)	This is the Maximum Information Rate (in kilobits per second).as configured for the group.

Column	Description
<ul style="list-style-type: none"> <li>CIR Avail Last 1 Min</li> <li>CIR Avail Last 15 Min</li> <li>CIR Avail Last 60 Min</li> </ul>	This is the Committed Information Rate (in kilobits per second) as averaged over the specified timeframe.
Mode	This is the QoS Control Mode as configured for the group: <ul style="list-style-type: none"> <li>Off</li> <li>DiffServ</li> <li>Max/Pri</li> <li>Min/Max</li> <li>Pri-Weighted</li> </ul>
Select	Click the radio button to make this group the active selected group.

### 6.3.4.1.4.2 Page Functionality Specific to Active QoS Control Mode

#### QoS Statistics



The page content that follows differs depending on the active QoS Control Mode.

The appearance of this table varies depending on your active QoS Control Mode. Examples are as follows:

**When QoS Control Mode = OFF, Max/Pri, Min/Max, or Pri-Weighted:**

QoS Statistics					
Index	Description	Tx Packets	Dropped Packets	Tx Packet Rate (packets/s)	Tx Data Rate (kbps)
1	Default	0	0	0	0
	<b>Per Group Total</b>	0	0	0	0

This table provides the statistics for all QoS Rules of a given QoS Group.

**When QoS Control Mode = DiffServ:**

QoS Statistics					
Priority	Description	Tx Packets	Dropped Packets	Tx Packet Rate (packets/s)	Tx Data Rate (kbps)
1	Class Select 7	0	0	0	0
2	Class Select 6	0	0	0	0
3	Exped Forward	0	0	0	0
3	Class Select 5	0	0	0	0
4	Class Select 4	0	0	0	0
5	Class Select 3	0	0	0	0
6	Class Select 2	0	0	0	0
7	Class Select 1	0	0	0	0
8	Assured Fwd 4	0	0	0	0
8	Assured Fwd 3	0	0	0	0
8	Assured Fwd 2	0	0	0	0
8	Assured Fwd 1	0	0	0	0
9	Default DSCP	0	0	0	0
	<b>Per Group Total</b>	0	0	0	0

This table provides the cumulative tally for each Code Point supported by Differentiated Services.

### 6.3.4.1.5 Status | Statistics | E1 Pages (ODM-840 only)

Use these *read-only* pages to view cumulative ODM-840 E1 traffic information. Click the **Transmit** or **Receive** tab to continue.

#### 6.3.4.1.5.1 Status | Statistics | E1 | Transmit

The screenshot shows the 'E1 | Transmit' page with the following components:

- Navigation:** Home, Admin, Configuration, Status, Utility, Statistics, Monitor, Traffic, Network, Compression, QoS, E1, Trending, Transmit, Receive.
- E1 QoS Statistics Table:**

Index	Description	Tx Packets	Dropped Packets	Tx Packet Rate (packets/s)	Tx Data Rate (kbps)
1	Default	0	0	0	0
<b>Per Group Total</b>		<b>0</b>	<b>0</b>	<b>0</b>	<b>0</b>
- E1 Transmit Statistics Table:**

Description	Counter
Compression Error Count	0
Tx Status Packet Count	0

Buttons: Refresh, Clear
- Transmit Time Slot Status (Auto Detected) Table:**

Slot	Type	Slot	Type	Slot	Type	Slot	Type
0	Idle	8	Idle	16	Idle	24	Idle
1	Idle	9	Idle	17	Idle	25	Idle
2	Idle	10	Idle	18	Idle	26	Idle
3	Idle	11	Idle	19	Idle	27	Idle
4	Idle	12	Idle	20	Idle	28	Idle
5	Idle	13	Idle	21	Idle	29	Idle
6	Idle	14	Idle	22	Idle	30	Idle
7	Idle	15	Idle	23	Idle	31	Idle

Button: Refresh

Figure 6-37. Status | Statistics | E1 | Transmit Page

#### E1 Transmit Statistics

From left to right:

"Description"	Counter
Compression Error Count	Tallies the number of compression errors detected.
Tx Status Packet Count	Tallies the number of status packets transmitted (status packets are transmitted every 500ms).

Click **[Refresh]** to update this table with its latest available statistics.

Click **[Clear]** to clear all E1 Transmit Statistics from the buffer.

#### Transmit Time Slot Status (Auto Detected)

- **Slot** – Numbered 0 through 31.

- **Type** – Slots are detected as **Idle** or **Active**. Idle time slots, once detected, do not utilize bandwidth.

Click **[Refresh]** to update this section with its latest available statistics.

### 6.3.4.1.5.2 Status | Statistics | E1 | Receive

The screenshot shows a web interface for monitoring E1 Receive statistics. At the top, there are navigation tabs: Home, Admin, Configuration, Status, Utility, Statistics, Monitor, Traffic, Network, Compression, QoS, E1, Trending, Transmit, and Receive. Below the tabs, there is a 'Clear E1 Receive Statistics' section with a 'Clear' button. The 'E1 Receive Packet Statistics' section contains a table with the following data:

	Rx Packets	Discarded Packets	Rx Packet Rate (pkts/s)	Rx Data Rate (kbps)
Total	0	0	0	0

Below this table is a 'Refresh' button. The 'E1 Receive Statistics' section contains a table with the following data:

Description	Counter
Decompression Error Count	0
Receive Status Packet Count	0
Jitter Buffer Overflow Count	0
Jitter Buffer Underflow Count	0

Below this table is a 'Refresh' button.

Figure 6-38. Status | Statistics | E1 | Receive Page

#### Clear E1 Receive Statistics

Click **[Clear]** to clear all E1 Receive Statistics from the buffer.

#### E1 Receive Packet Statistics

From left to right:

Column	Description
Rx Packets	Tallies the number of RAN packets received.
Discarded Packets	Tallies the number of discarded Rx packets (errored packets).
Rx Packet Rate (pkts/s)	Tallies the current number of packets received (packets per second).
Rx Data Rate (kbps)	Reports the current Rx data rate (kilobits per second).

Click **[Refresh]** to update this section with its latest available statistics.

#### E1 Receive Statistics

Description	Counter
Decompression Error Count	Tallies the number of decompression errors detected.
Receive Status Packet Count	Tallies the number of status packets received. Status packets are received every 500ms.

Description	Counter
Jitter Buffer Overflow Count	Tallies the number of times that the jitter buffer has overflowed (indicates too much data – jitter latency is not set high enough if count increases consistently).
Jitter Buffer Underflow Count	Tallies the number of times that the jitter buffer has underflowed (indicates not enough data – jitter latency is not set high enough if count increases consistently).

Click **[Refresh]** to update this section with its latest available statistics.

### 6.3.4.1.6 Status | Statistics | Trending (ODM-840 only)



#### Appendix J. RAN/WAN OPTIMIZATION



- 1) E1 Interface operation is not available with the ODMR-840 Reduced Form Factor Remote Router or the ODMR-840B Board Set.
- 2) These pages are functional only when the “G.703 E1 Interface / RAN Optimization” FAST and hardware options are installed and activated.

This page provides an updating graphical representation of several ODM-840 IP traffic handling statistics. When the presence of the optional E1 FAST feature is detected and enabled, E1 RAN Optimization trending characteristics are also provided.

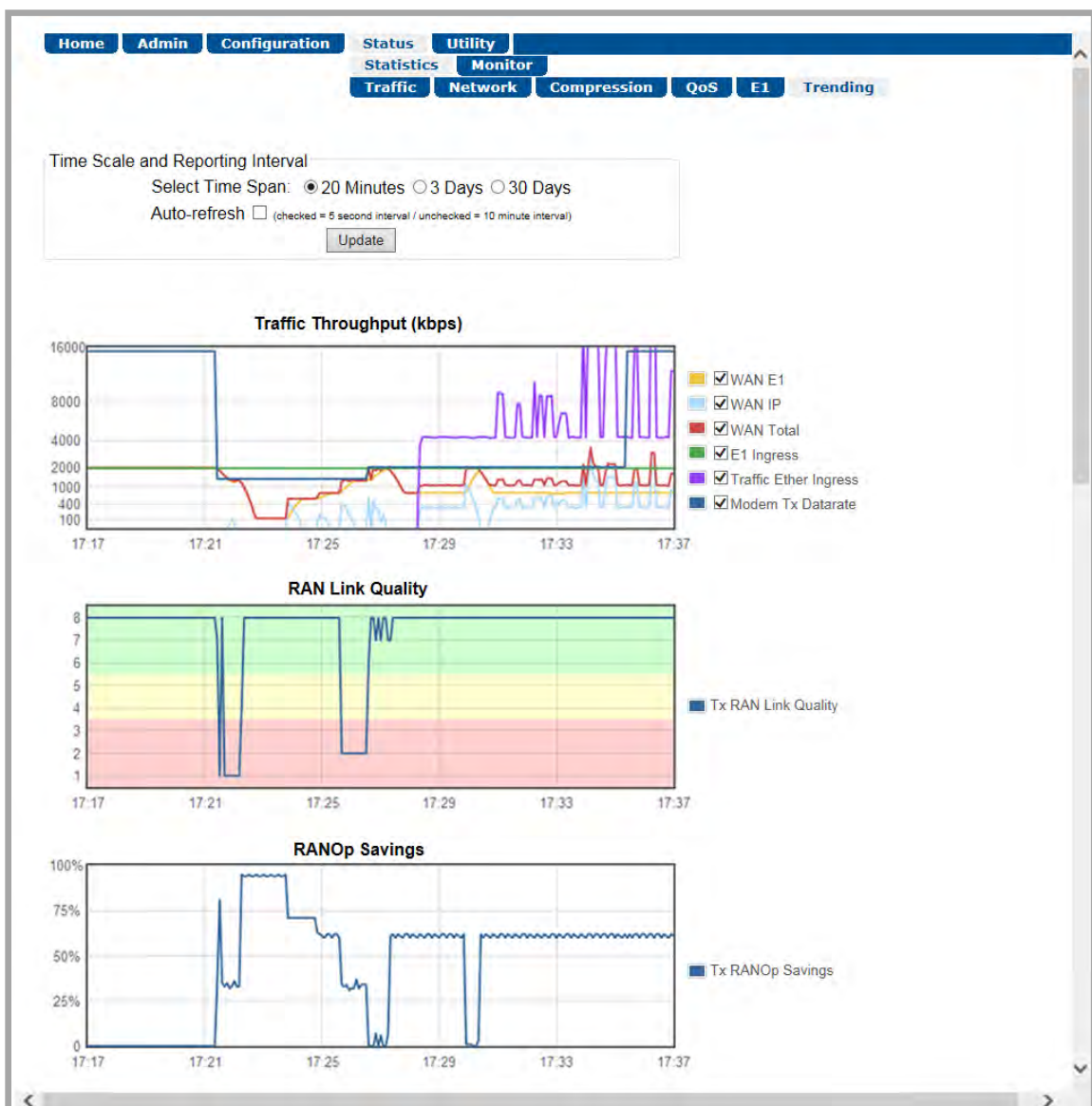

Figure 6-39. Status | Statistics | Trending Page (Select Time Span = 20 minutes)

**To initialize the page:** Select the Time Span for the graphs as **20 minutes, 3 Days, or 30 Days**. Then, select **Auto Update** if you wish to set the trending data refresh interval from the default of **10 minutes to 5 seconds**. Click **[Update]** to execute your selection. Allow a few seconds for the graphs to visually update.

### Traffic Throughput (kbps) Graph

This graph displays utilization of the available data traffic types:

Data Traffic Type	Description
WAN E1	WAN data rate associated with E1/RAN traffic.
WAN IP	WAN data rate associated with IP traffic.
WAN Total	WAN data rate total (WAN E1 + WAN IP).
E1 Ingress	Data rate of E1 time slots carried (64K * number of time slots).
Traffic Ether Ingress	Data rate of Ethernet traffic (WAN/E1 ingress utilization).
Modem Tx Datarate	Modem transmit data rate.

Select as many or as few of the applicable types from the legend to the right of the graph. Allow a few seconds for the graph to display the selected traffic data types.

### RAN Link Quality Graph

This graph provides the performance indicator for the Tx RAN Link Quality metric, a qualitative measure of the voice quality predicated by a) the level of compression, and b) traffic packet optimization required to accommodate the incoming traffic into the available WAN (satellite) bandwidth.

Association of the Link Quality Metric to its comparative Link Quality is as follows:

Link Quality Metric	Link Quality
8	Excellent
7	Very Good
6	Good
5	Fair
4	Average
3	Poor
2	Very Poor
1	

Note that '8' on the graph indicates the highest quality, with no voice traffic optimization.

### RANOp Savings Graph

This graph provides the performance indicator for Tx RAN Optimization on the actual "percentage of savings" basis.



## 6.3.4.2 Status | Monitor Pages

The **Monitor** pages provide event logging, and operational status windows. Click the **Events** or **Alarms** tab to continue.

### 6.3.4.2.1 Status | Monitor | Events

Use this *read-only* page to view the unit alarms summary, input port status, plus a scrollable window that displays any events and alarms as logged by the unit during normal operation.

The screenshot displays the 'Status | Monitor | Events' page. At the top, there is a navigation bar with tabs for Home, Admin, Configuration, Status, Utility, Statistics, Monitor, Events, and Alarms. The 'Monitor' tab is selected. Below the navigation bar, the page is divided into three main sections:

- System Monitor:** Displays 'Unit Temperature: +35C' with a 'Refresh' button.
- Alarms:** Lists several status messages: 'Unit Alarm: Unit Ok', 'Tx Alarm: Tx Traffic Ok', 'Rx Alarm: Rx Traffic Ok', 'BUC Alarm: BUC Ok', 'LNB Alarm: LNB Ok', and 'Traffic Ethernet Alarm: Traffic Ethernet Ok'. A 'Refresh Alarms' button is located below the list.
- Events:** Contains a table with the following data:

Date	Time	Description
02/12/15	17:43:33	INFO - Event Log Cleared

Below the table are 'Refresh Events' and 'Clear Event Table' buttons, and a counter 'Number of Events: 1'.

Figure 6-40. Status | Monitor | Events Page

## Alarms

This section summarizes the **Unit**, **Tx**, **Rx**, **BUC** (when installed), **LNB** (when installed), and **Traffic** alarms compiled since the logging buffer was last cleared.

## Events



The “STORED EVENT” LED on the physical and virtual front panels lights amber to indicate the presence of any stored event(s) or alarm(s).

Each logged event or alarm is **Date**- and **Time**-stamped, and a **Description** is provided.

Click **[Clear Event Table]** to delete all existing logged entries from the Events log. The log and counter then resets to a single entry: “**INFO – Event Log Cleared**”.

### 6.3.4.2.2 Status | Monitor | Alarms

This page indicates whether or not an event or alarm has been logged for a specific item since the logging buffer was last cleared. Use this page to view the current unit operating status, and to control how the alarm masking parameters are processed by the unit.

The screenshot shows a web interface for monitoring alarms. At the top, there are navigation tabs: Home, Admin, Configuration, Status, and Utility. Under 'Status', there are sub-tabs for Statistics, Monitor, Events, and Alarms. A legend indicates that a green dot means 'NO ALARM', a yellow dot means 'PREVIOUSLY ALARMED', and a red dot means 'CURRENTLY ALARMED'. Below the legend is a 'Clear Alarms' button labeled 'Clear Previously Alarmed'. The main content is organized into several sections, each with a title and a table of alarms:

- Unit Alarms:** A table with 6 columns: Name, Status, Mask, Name, Status, Mask. It lists alarms like "5V POWER", "TX SYNTH PLL LOCK", "COMPRESSION FPGA LOAD", "TEMPERATURE EXCEEDED", "HARD\_RESET", "12V POWER", "TXRX FPGA PLL LOCK", "TXRX FPGA LOAD", and "TXRX FPGA DDR2 CRC". All statuses are green, and all mask boxes are unchecked.
- Rx Alarms:** A table with 6 columns: Name, Status, Mask, Name, Status, Mask. It lists "DEMODULATOR LOCK", "ESNO", and "FRAME SYNC". All statuses are green, and all mask boxes are unchecked.
- BUC Alarms:** A table with 6 columns: Name, Status, Mask, Name, Status, Mask. It lists "BUC CURRENT", "BUC COMMS", "BUC TEMP", "BUC VOLTAGE", and "BUC PLL". All statuses are green, and all mask boxes are unchecked.
- LNB Alarms:** A table with 6 columns: Name, Status, Mask, Name, Status, Mask. It lists "LNB CURRENT" and "LNB VOLTAGE". Both statuses are green, and both mask boxes are unchecked.
- Ethernet Alarms:** A table with 6 columns: Name, Status, Mask, Name, Status, Mask. It lists "NO LINK GE" and "NO LINK ETH". Both statuses are green, and both mask boxes are unchecked.
- E1 Alarms:** A table with 6 columns: Name, Status, Mask, Name, Status, Mask. It lists "E1 LOSS OF FRAME", "E1 ALARM INDICATION SIGNAL", "E1 INBAND WAN", "E1 LOSS OF SIGNAL", and "E1 CONFIGURATION". All statuses are green, and all mask boxes are unchecked.

Each table has 'Clear Masks', 'Submit', and 'Mask All' buttons at the bottom.

Figure 6-41. Status | Monitor | Alarms Page

#### Legend

Operational status is color-coded for quick reference:

State	Means	Description
Green	"No Alarm"	This indicates that no event or alarm has been logged since the logging buffer was last cleared – status is OK..
Yellow	"Previously Alarmed"	This indicates that this alarm was once active, but has since been cleared.
Red	"Currently Alarmed"	This indicates that an event or alarm has been logged since the logging buffer was last cleared – status is FAULTED.

## Clear Alarms

Click **[Clear Previously Alarmed]** to update this page with the latest available logged event or alarm information.

## Unit / Rx / BUC / LNB / Ethernet / E1 Alarms



- 1) The "BUC Alarms" and "LNB Alarms" sections are functional only when these optional products are installed and recognized as operational.
- 2) The "E1 Alarms" section is functional only when the "G.703 E1 Interface / RAN Optimization" FAST Feature and hardware options are installed and activated.
- 3) Precision Time Protocol is not available in this firmware release. The "PTP Alarms" section on this page, while available and selectable, is therefore non-functional and is not shown in this manual.

Typical for these remaining page sections:

Section Column	Description
Name	This is the name of the specific function.
Status	The event/alarm status "LED" for each item is displayed here – see the Legend page section.
Mask	Click the box to select alarm masking for a specific function.

- Click **[Clear Masks]** to deselect the Mask box for all listed functions.
- Click **[Mask All]** to select the Mask box for all listed functions.
- Click **[Submit]** to save.

## 6.3.5 Utility Pages

Click the **Utility**, **Carrier ID**, or **Reboot** tab to continue.

### 6.3.5.1 Utility | Utility

Use this page to define and access a variety of top-level system operation controls, stored unit configurations, and test utilities.

The screenshot shows the 'Utility | Utility' page with the following sections and fields:

- Modem**
  - Unit/Site Name: ODM-840
  - System Contact: cdmipsupport@comtech
  - System Location: (480) 333-4357
  - Set Time(hh:mm:ss): 17:47:31
  - Set Date(dd/mm/yy): 12/02/15
  - Circuit ID: 1
  - G.703 Clock Extended Mode: Off
  - 10 MHz Internal Adjustment: 999 (-999 to 999)
  - Test Mode: Normal Mode
- Save/Load Configuration**
  - Select Location: 1
  - Save Configuration
  - Select Location: 1
  - Load Configuration
- BERT Config**
  - Tx Bert State: Off
  - Tx Bert Pattern: 2<sup>23</sup>-1
  - Error Insert: Off
  - Rx Bert State: Off
  - Rx Bert Pattern: 2<sup>23</sup>-1
- BERT Monitor**
  - Total Errored Bits: 0.000E+00
  - BER: 0.000E+0
  - Total Bits: 0.000E+00
  - Restart
  - Update
- Redundancy**
  - Current Redundancy State:
  - Offline Unit Mgmt IP: 192.168.1.13
  - Offline Unit Status: No\_1F1
  - Force Redundancy Switch
  - Redundancy Detect Latch Not Set
- Console Configuration**
  - Console Configuration: RS232-8N1-38400

Figure 6-42. Utility | Utility Page

#### Modem

- **Unit Name** – Enter a product label (e.g., **ODM-840**) here.
- **System Contact / System Location** – Enter the e-mail and telephone contact information for Comtech EF Data Product Support here.

Click **[Submit]** to save.

- **Set Time (hh:mm:ss)** – Use the HH:MM:SS time format to set the time, where HH=hour [00-23]; MM=minutes [00-59]; and SS=seconds [00-59].
- **Set Date (dd/mm/yy)** – Use the DD/MM/YY European time format to set the date, where DD=day [01-31]; MM=month [01-12]; and YY=year [00-99].

Click **[Submit]** to save.

- **Adjustment for Internal 10 MHz Reference** (-999 to +999) – Enter a value to set the adjustment for the Internal 10 MHz High Stability Reference.

Click **[Submit]** to save.

## Save/Load Configuration

This section allows you to save, and then load (recall) up to 10 configuration sets:

- **To save a configuration set:**
  - *First*, adjust all operational configuration parameters to suit.
  - *Then*, use the top (Save) **Select Location** drop-down to select **1** through **10**.
  - *Finally*, click **[Save Configuration]** to store the configuration set.
- **To load (recall) a configuration set:**
  - First, use the bottom (Load) **Select Location** drop-down to select **1** through **10**.
  - Then, click **[Load Configuration]** to recall the selected configuration set.

## BERT (Bit Error Rate Test)



**CAUTION – Enabling BERT will disrupt any messaging in use (ACM, ECM, VMS, CDRP, ARP) across the Advanced VSAT Network! This may result in a negative impact on the operation of the network!**

- **Tuner Select** – Use the drop-down list select the active tuner (demodulator). Depending on the chassis configuration, the minimum selection is **1** or **2**; the maximum is from **1** to **12**. Click **[Submit Changes]** when done. Any further BERT configuration or operational settings will apply to the selected tuner.

## BERT Config

- Configure the **Rx BERT State** as **On** or **Off**.
- Configure the **Rx BERT Pattern** as **2<sup>23</sup>-1** ( $2^{23}-1$ ) or **2047**.

Click **[Submit]** to save the BERT settings and execute the test.

## BERT Monitor

This section displays the ongoing BERT.

- Click **[Restart]** to *restart* the BERT Monitor.
- Click **[Update]** to *refresh* a test that is already in progress.



The ODM-840 does not accept IP traffic while a BERT is in progress.

## Redundancy (FUTURE)



Redundancy is operational only when an optional Comtech EF Data CRS-170A or CRS-180 Redundancy Switch is installed, and the ODM-840 is recognized as part of a 1:1 or 1:N redundant pair.

## Console Configuration

- **Console Configuration** – Use the drop-down list to set the EIA-232 or EIA-485 communication parameters for the rear panel DB-9M serial '**CONSOLE**' port:
  - RS232-8N1-38400
  - RS485-8N1-9600
  - RS485-8N1-57600
  - RS232-8N1-57600
  - RS485-8N1-19200
  - RS485-8N1-115200
  - RS232-8N1-115200
  - RS485-8N1-38400

Click **[Submit]** to save.

## 6.3.5.2 Utility | Carrier ID



### Appendix E. CARRIER ID (DVB-CID METACARRIER®)

The screenshot shows the Carrier ID configuration page. At the top, there are navigation tabs: Home, Admin, Configuration, Status, Utility, Carrier ID, and Reboot. The Utility tab is selected, and the Carrier ID sub-tab is active. The main content area is titled "Carrier ID" and contains the following fields:

- Mgmt MAC Address: 00:06:b0:01:93:c0
- Latitude: 90 (with a degree symbol) and a dropdown menu set to "South"
- Longitude: 180 (with a degree symbol) and a dropdown menu set to "West"
- Telephone Number: 0
- Custom Message: 0

Below the fields, there is a "Submit" button and a note: "(Note: Carrier ID is ON at symbol rates of 128 Ksps or greater.)"

Figure 6-43. Utility | Carrier ID Page

### Carrier ID

- **Mgmt MAC Address** – This is the *read-only* MAC Address for the ODM-840's M&C card.
- **Latitude** – Set the modem's physical location in **Latitude** in the form **DDMM.mmC**, where:
  - **DD** = degrees (00 to 90);
  - **MM.mm** = whole (00 to 60) and fractional (0 to 99 – tenths or hundredths) minutes;
  - **C** = Use the drop-down list to set the compass cardinal point as **North** or **South**.
- **Longitude** – Set the modem's physical location in **Longitude** in the form **DDDMM.mmC**, where:
  - **DDD** = degrees (000 through 180);
  - **MM.mm** = whole (00 to 60) and fractional (0 to 99 – tenths or hundredths) minutes;
  - **C** = Use the drop-down list to set the compass cardinal point as **East** or **West**.
- Enter a **Telephone Number** to provide a valid emergency contact number to call to resolve operational issues – e.g., in case the modulator's Tx output is causing interference on the satellite. Providing this phone number allows a satellite operator to quickly call the person(s) responsible for correcting any issues.
- Create a **Custom Message** to provide additional information that may be useful in resolving operational issues, e.g., to quickly resolve interference.

Click **[Submit]** to save.

### 6.3.5.3 Utility | Reboot

Use this page to perform a soft reboot of the ODM-840. Note that the function of this page is identical to the **System Reboot** section of the **Admin | Firmware** page (Sect. 6.3.2.4).

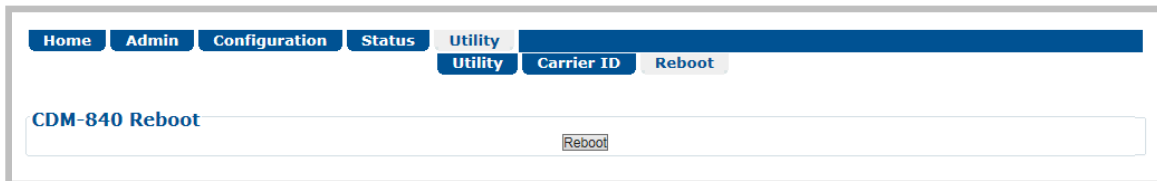
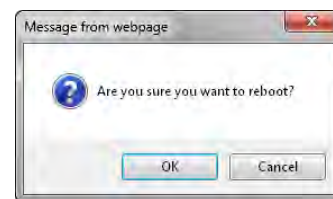

Figure 6-44. Utility | Reboot Page

#### System Reboot

Click **[Reboot]** to reboot the unit. A dialogue box appears to prompt continuation or cancellation of the reboot process:



Click **[OK]** to continue the reboot process, or **[Cancel]** to abort the process and return to the **Utility | Reboot** page.

Once the reboot process resumes, the **Utility | Reboot** page is replaced with the dynamic message **“Please wait... ODM-840 is rebooting. Login will be required in XX seconds”** – the approximate time count decrements to 0 seconds before the unit is available. After the reboot, login is required once again to resume use of the HTTP Interface.



# Chapter 7. SERIAL-BASED REMOTE PRODUCT MANAGEMENT



**UNLESS OTHERWISE NOTED – This chapter collectively refers to the Comtech EF Data Advanced VSAT Series ODM-840 Remote Router, ODMR-840 Reduced Form Factor Remote Router, and ODMR-840B Remote Router Board Set as the ODM-840.**

---

## 7.1 Overview



**1) THE SERIAL-BASED REMOTE PRODUCT MANAGEMENT INTERFACE IS INTENDED TO PROVIDE TWO IMPORTANT CAPABILITIES:**

- **FIRST, IT ALLOWS YOU TO ESTABLISH IP COMMUNICATIONS (HTTP, SNMP) WHEN THE UNIT IS FIRST BEING CONFIGURED.**
- **SECOND, THE INTERFACE ALLOWS YOU TO BRING THE ODM-840 BACK ONLINE THROUGH THE SERIAL OR TELNET INTERFACE OVER A VERY SLOW SPEED "BACKUP CHANNEL".**

**THIS INTERFACE IS NOT INTENDED TO BE A FULL FEATURED INTERFACE TO CONFIGURE ALL ASPECTS OF THE MODEM. RATHER, ITS PURPOSE IS TO PROVIDE ENOUGH COMMANDS TO ALLOW A TERMINAL TO BE BROUGHT BACK ONLINE.**

**ONCE YOU RE-ESTABLISH COMMUNICATIONS, YOU MAY USE THE STANDARD INTERFACES (HTTP, SNMP, NETVUE) TO EXECUTE ANY ADDITIONAL DETAILED CONFIGURATION/CONTROL/MONITORING FUNCTIONS.**

**COMTECH EF DATA RECOMMENDS USE OF THE SERIAL-BASED REMOTE PRODUCT MANAGEMENT INTERFACE ONLY FOR ADVANCED USERS.**

**2) YOU MAY PROCEED WITH SERIAL-BASED REMOTE PRODUCT MANAGEMENT, ASSUMING THAT:**

- **YOU ARE OPERATING THE ODM-840 WITH THE LATEST VERSION FIRMWARE FILES.**
- **YOU HAVE CONNECTED THE ODM-840 TO A USER-SUPPLIED, WINDOWS-BASED PC AS FOLLOWS:**
  - **THE PC SERIAL PORT IS CONNECTED TO THE ODM-840 OR ODMR-840 ‘CONSOLE/REDUNDANCY’ PORT WITH A USER-SUPPLIED 19-PIN-TO-9-PIN ADAPTER SERIAL CABLE.**

**(THE ODMR-840B BOARD SET FEATURES A 26-PIN RIBBON CONNECTOR. CONTACT COMTECH EF DATA PRODUCT SUPPORT FOR INSTRUCTIONS ON COMPLETING ANY SERIAL-BASED CONNECTIONS FOR YOUR SPECIFIC ODMR-840B INSTALLATION.)**

- **THE PC ETHERNET PORT IS CONNECTED TO THE ODM-840’S ‘ETHERNET T/M’ PORT WITH THE AVAILABLE OUTDOOR ETHERNET CABLE, EITHER DIRECTLY OR WITH A USER-SUPPLIED HUB OR SWITCH.**
- **THE PC IS RUNNING A TERMINAL EMULATION PROGRAM (FOR OPERATION OF THE ODM-840 SERIAL INTERFACE), AND A COMPATIBLE WEB BROWSER (FOR OPERATION OF THE ODM-840 WEB SERVER INTERFACE).**
- **YOU HAVE NOTED THE ODM-840 MANAGEMENT IP ADDRESS HAS BEEN NOTED USING THE ODM-840 SERIAL INTERFACE (FIGURE 7-1). (THE FIRMWARE INFORMATION (I.E., REVISION LETTERS, VERSION NUMBERS, ETC.) AS SHOWN MAY DIFFER.)**

ODM-840 Serial Remote Product Management is available through the EIA-232 operational interface, where the ‘Controller’ device (the user PC or an ASCII dumb terminal) is connected directly to the ‘Target’ device (the ODM-840, via the ODM-840 or ODMR-840 ‘CONSOLE/REDUNDANCY’ port). This connection makes possible serial remote monitor and control (M&C) of the system through its ODM-840 Serial Interface.

Through this EIA-232 connection (for the control of a single device), data is transmitted in asynchronous serial form, using ASCII characters. Control and status information is transmitted in packets of variable length in accordance with the structure and protocol defined later in this chapter.

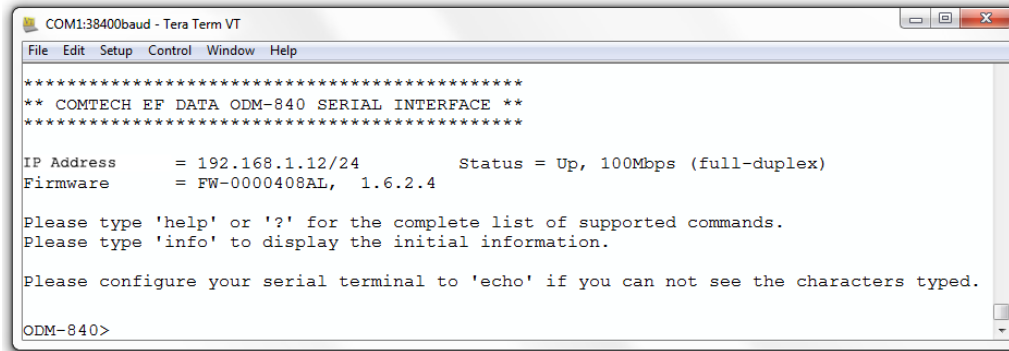

**Figure 7-1. ODM-840 Serial Interface Example**

Access to the interface is accomplished with a user-supplied terminal emulator program such as Tera Term or HyperTerminal. Use this utility program to first configure serial port communication and terminal display operation:

- **38400 bps (Baud Rate)**
- **8 Data Bits**
- **1 Stop Bit**
- **Local Echo=ON**
- **Parity=NO**
- **Port Flow Control=NONE**
- **Display New line Rx/Tx: CR**

When the user-supplied terminal emulator program is configured correctly, upon power-up of the system, the COMTECH EF DATA ODM-840 SERIAL INTERFACE Info Screen appears, followed by the **ODM-840>** command prompt. From here, type **“help[cr]”** or **“?[cr]”** (without the quotes) to display the available “set” commands and “get” queries, and to review instructions for using the interface.

---

## 7.2 Remote Commands and Queries Overview

### 7.2.1 Basic Protocol

In an EIA-232 configuration, the Controller device is connected directly to the Target device via a two wire-plus-ground connection. All data is transmitted in framed packets as asynchronous serial characters, suitable for transmission and reception to the Controller using a universal asynchronous receiver/transmitter (UART). Controller-to-Target data is carried via EIA-232 electrical levels on one conductor, and Target-to-Controller data is carried in the other direction on the other conductor:

- **Controller-to-Target:** The Controller device (e.g., the user PC/Serial Interface) is used to “set”, or transmit, instructions (commands) to – or to “get”, or request, information from (queries) – the Target device (i.e., the CDM-800).

- **Target-to-Controller:** The Target, in return, only transmits response information to the Controller when specifically directed by the Controller.

For Serial Remote Control, all issued commands (**Controller-to-Target**) require a response (**Target-to-Controller**). This response is either to return data that has been queried by the Controller, or to confirm the Target’s receipt of a command to change the Target’s configuration.

## 7.2.2 Packet Structure

The exchange of information is transmitted, Controller-to-Target and Target-to-Controller, in packets. Each packet contains a finite number of bytes consisting of printable ASCII characters, excluding ASCII code 127 (DELETE).

In this context, the Carriage Return and Line Feed characters are considered printable. With one exception, all messages from Controller-to-Target require a response – this will be either to return data that has been requested by the Controller, or to acknowledge reception of an instruction to change the configuration of the Target.

Controller-to-Target (Issued Command or Query)						
Start of Packet	Target Address	Address Delimiter	Instruction Code	Code Qualifier	Optional Arguments	End of Packet
< ASCII Code 60 (1 character)	0000 (default) (4 characters)	/ ASCII Code 47 (1 character)	(3 characters)	= or ? ASCII Codes 61 or 63 (1 character)	(n characters)	Carriage Return ASCII Code 13 (1 character)

**Packet “issued command” example:** <0000/RSH=30[cr]

**Packet “issued query” example:** <0000/TFQ?[cr]

Target-to-Controller (Response to Command or Query)						
Start of Packet	Target Address	Address Delimiter	Instruction Code	Code Qualifier	Optional Arguments	End of Packet
> ASCII Code 62 (1 character)	0000 (default) (4 characters)	/ ASCII Code 47 (1 character)	(3 characters)	=, ?, !, *, # (ASCII Codes 61, 63, 33, 42, or 35) (1 character)	(n characters)	Carriage Return ASCII Code 13 (1 character)

**Packet example – response received for issued query:** >0000/BBU=107[cr][lf]

Detailed description of the packet components follow.

---

### 7.2.2.1 Start of Packet

- **Controller-to-Target:** This is the character '<' (ASCII code 60).
- **Target-to-Controller:** This is the character '>' (ASCII code 62).

The '<' and '>' characters indicate the start of packet. They may not appear anywhere else within the body of the message.

---

### 7.2.2.2 Target Address

In EIA-232 applications, this value is set to **0000**.



**The Target Address designates the packet destination. The Controller does not have its own address. After the Controller sends a packet with the designated Target Address, the Target responds to the Controller, using this same address, to indicate the source of the packet.**

---

### 7.2.2.3 Address Delimiter

This is the “forward slash” character '/' (ASCII code 47).

---

### 7.2.2.4 Instruction Code

This is a three-character alphanumeric sequence that identifies the message subject. Uppercase alphabetic characters ('A' to 'Z', ASCII Codes 65 to 90) and the numbers '0' to '9' \*ASCII Codes 48 to 57) may be used. Wherever possible, each instruction code is named to serve as a mnemonic for its intended operation. This helps you interpret the code function, should it be shown in its raw ASCII form.

**For example:** **MLC** for **Management Link Configuration**, **IPA** for **Management IP Address**, etc.

---

### 7.2.2.5 Instruction Code Qualifier

This is a single character that further qualifies the preceding instruction code.

### 7.2.2.5.1 Controller-to-Target Instruction Code Qualifiers

The only permitted characters are '=' and '?'.

#### **= (ASCII Code 61)**

This character is used as the Assignment Operator (AO). It establishes that the Instruction Code that precedes it is issued as a **command** to assign or configure operation. The instruction set that follows serves to assign the Target's new parameter setting or operational value.

**For example:** From Controller-to-Target, <0/IG1=aaa.bbb.ccc.ddd/yy means "set the 'ETHERNET | TRAFFIC | GE' port IP Address to aaa.bbb.ccc.ddd/yy"

#### **? (ASCII Code 63)**

This character is used as the Query Operator (QO). It establishes that the Instruction Code that precedes it is issued as a **query** that returns the Target's current configured parameter setting or operational value.

**For example:** From Controller-to-Target, <0/IG1? means "what is the current 'ETHERNET | TRAFFIC | GE' port IP Address?"

### 7.2.2.5.2 Target-to-Controller Instruction Code Qualifiers

The permitted characters are '=', '?', '\*', '!', '\*', and '#'.

#### **=(ASCII Code 61)**

This character is used in two ways:

1. If the Controller sends a query to the Target.

**For example:** <0/TFQ? (meaning "what is the current value of the transmit frequency?") – the Target responds with >0000/TFQ=xxxx.xxxx, the value for that queried parameter.

2. If the Controller sends an instruction to set a parameter to a particular value, and the value sent is valid, the Target acknowledges the message and responds with, for example, >0000/TFQ=(with no message arguments).

### **? (ASCII Code 63)**

If the Controller issues a command to set a parameter to a particular value, and the value sent is not valid, the Target then acknowledges the message and responds with '?'. This indicates that there was an error in the message sent by the Controller.

**For example:** >0000/TFQ? (with no message arguments).

### **! (ASCII Code 33)**

If the Controller issues a command that the Target does not recognize, the Target responds by echoing the invalid instruction code, followed by '!'.

**For example:** >0000/ABC!

### **\* (ASCII Code 42)**

If the Controller issues a command to set a parameter to a particular value, and the value sent is valid, but the modem will not permit that particular parameter to be changed at present, the Target responds by echoing the valid instruction code, followed by '\*'.

**For example:** >0000/TFQ\* (with message arguments)

### **# (ASCII Code 35)**

If the Controller sends a correctly formatted command, but the Target is not in Remote Mode, the unit does not allow reconfiguration and responds by echoing the valid instruction code, followed by '#'.

**For example:** >0000/TFQ#

---

### 7.2.2.6 Optional Message Arguments

Arguments are not required for all messages.

Comma ',' (ASCII Code 44), period '.' (ASCII Code 46), the numbers '0' to '9' (ASCII Codes 48 to 57), and the uppercase alphabetic characters 'A' to 'Z' (ASCII Codes 65 to 90) may be used.

---

### 7.2.2.7 End of Packet

- **Controller-to-Target:** This is the 'Carriage Return' ([CR]) character (ASCII code 13).
- **Target-to-Controller:** This is the two-character sequence 'Carriage Return', 'Line Feed' ([cr][lf]) (ASCII codes 13 and 10). Both indicate the valid termination of a packet.



## 7.3 Remote Commands and Queries

### 7.3.1 Table Indexes

**Notes:**

1) **Index Columns** – Where Column ‘C’=Command, and Column ‘Q’=Query, columns marked ‘X’ designate the instruction code as *Command only, Query only, or Command or Query.*

2) **In the tables that follow, the following codes are used in the ‘Response to Command’ column (see Sect. 7.2.2.5.2):**

= Message ok

# Message ok, but unit is not in **Remote** mode.

? Received ok, but invalid arguments were found.

~ Time out of a pass-through message, either to via EDMAC or a local ODU

^ Message ok, but unit is in **Ethernet** mode.

#### Sect. 7.3.2 Transmit (Tx) Parameters Commands and Queries

CODE	C	Q	PAGE
TAR	X	X	7-12
TDR		X	7-12
TFQ	X	X	7-12

CODE	C	Q	PAGE
TMC	X	X	7-12
TPL	X	X	7-13
TSI	X	X	7-13

CODE	C	Q	PAGE
TSR	X	X	7-13
TXO	X	X	7-13
VFQ		X	7-13

#### Sect. 7.3.3 Receive (Rx) Parameters Commands and Queries

CODE	C	Q	PAGE
RFQ	X	X	7-14
RGS	X	X	7-14
RMC		X	7-14

CODE	C	Q	PAGE
RSI		X	7-15
RSR	X	X	7-15

CODE	C	Q	PAGE

#### Sect. 7.3.4 Demodulator Parameters Commands and Queries

CODE	C	Q	PAGE
ESN		X	7-16
RSL		X	7-16

CODE	C	Q	PAGE

CODE	C	Q	PAGE

**Sect. 7.3.5 Transmit (Tx) BERT Command or Query**

CODE	C	Q	PAGE
BTX	X	X	7-17

CODE	C	Q	PAGE

CODE	C	Q	PAGE

**Sect. 7.3.6 Receive (Rx) BERT Command or Query**

CODE	C	Q	PAGE
BRX	X	X	7-17

CODE	C	Q	PAGE

CODE	C	Q	PAGE

**Sect. 7.3.7 BUC (Block Up Converter) Parameters Commands and Queries**

CODE	C	Q	PAGE
ATT	X	X	7-17
BAD	X	X	7-17
BCH	X	X	7-18
BCL	X	X	7-18

CODE	C	Q	PAGE
BDC		X	7-18
BDV		X	7-18
BFR	X	X	7-18
BOE	X	X	7-18

CODE	C	Q	PAGE
BOL		X	7-18
BPA		X	7-19
BPC		X	7-19
BPS	X	X	7-19

CODE	C	Q	PAGE
BSV		X	7-19
BUT		X	7-20

**Sect. 7.3.8 LNB (Low Noise Block Down Converter) Parameters Commands and Queries**

CODE	C	Q	PAGE
LNC		X	7-21
LNH	X	X	7-21
LNL	X	X	7-21

CODE	C	Q	PAGE
LNR	X	X	7-21
LPS	X	X	7-21
LVO		X	7-21

CODE	C	Q	PAGE

**Sect. 7.3.9 Unit Parameters Commands and Queries**

CODE	C	Q	PAGE
ADJ	X	X	7-25
CID	X	X	7-25
DPW	X		7-25
EID		X	7-22

CODE	C	Q	PAGE
FLT		X	7-24
FRW		X	7-25
GLG	X		7-25
IMG		X	7-26
IPA	X	X	7-26

CODE	C	Q	PAGE
MAC		X	7-26
MLC	X	X	7-26
NPS		X	7-27
REN		X	7-27

CODE	C	Q	PAGE
SBS	X	X	7-27
SNO		X	7-27
SRC	X	X	7-27
SSN	X	X	7-28
SWC	X	X	7-28
SWR		X	7-28

CODE	C	Q	PAGE
TST	X	X	7-28

**Sect. 7.3.10 Bulk Configuration String Commands**

CODE	C	Q	PAGE
CLD	X		7-28
CST	X		7-28

CODE	C	Q	PAGE

CODE	C	Q	PAGE

**Sect. 7.3.11 Redundancy Commands and Queries**

CODE	C	Q	PAGE
FSW	X		7-29
RED		X	7-29

CODE	C	Q	PAGE

CODE	C	Q	PAGE

**Sect. 7.3.12 Vipersat Management System (VMS) Commands and Queries**

CODE	C	Q	PAGE
VID	X	X	7-30
VMI	X	X	7-30
VMP	X	X	7-30

CODE	C	Q	PAGE

CODE	C	Q	PAGE

**Sect. 7.3.13 Entry Channel Mode (ECM) Commands and Queries**

CODE	C	Q	PAGE
EBP	X	X	7-31
EGI	X	X	7-31
EMD	X	X	7-31

CODE	C	Q	PAGE
EMI	X	X	7-31
EPH	X	X	7-31
ERF	X	X	7-31

CODE	C	Q	PAGE
ETF	X	X	7-31

**Sect. 7.3.14 Miscellaneous Utility Commands**

CODE	C	Q	PAGE
DPD	X		7-32

CODE	C	Q	PAGE
FRB	X		7-32

CODE	C	Q	PAGE
PING	X		7-32

### 7.3.2 Transmit (Tx) Parameters Commands and Queries

Parameter Type	Command (Instruction Code & Qualifier)	Number of Arguments for Command or Response to Query	Description of Arguments (Note that all arguments are ASCII numeric codes from 48 and 57)	Response to Command (Target to Controller)	Query (Instruction Code & Qualifier)	Response to Query (Target to Controller)
Tx Rolloff	TAR=	1 byte	Command or Query. Sets or returns Tx Rolloff slope in the form x, where: 0=20% 1=25% 2=35% <b>EXAMPLE:</b> <0/TAR=2[cr]	TAR = TAR? TAR * TAR #	TAR?	TAR =x (see Description of Arguments)
Tx Data Rate	N/A	10 bytes	Query only. Returns Tx Data Rate in the form dddddd.ddd, where: dddddd.ddd=value from 16 kbps to 15358.508 kbps, in 1 bps increments. <b>EXAMPLE:</b> <0/TDR?[cr] >0000/TDR=002047.999[cr][lf] <b>NOTE:</b> The corresponding data rate will be automatically updated as per the CCM MODCOD or the MODCOD currently being received.	TDR = TDR? TDR *	TDR?	TDR=xxxxxx.xxx (see Description of Arguments)
Tx Frequency	TFQ	9 bytes	Command or Query. Sets or returns Tx Frequency in the form xxxx.xxxx, where: xxxx.xxxx=value from 0950.0000 to 2150.0000 MHz (L-Band), in 100 Hz increments. <b>EXAMPLE:</b> <0/TFQ=0950.9872[cr]	TFQ= TFQ? TFQ * TFQ#	TFQ?	TFQ =xxxx.xxxx (see Description of Arguments)
Tx MODCOD	TMC=	2 bytes	Command or Query. Sets or returns Tx Modulation in the form xx, where: 0=BPSK 0.488 1=QPSK 0.533 2=QPSK 0.631 3=QPSK 0.706 4=QPSK 0.803 5=8-QAM 0.642 6=8-QAM 0.711 7=8-QAM 0.780 8=16-QAM 0.731 9=16-QAM 0.780 10=16-QAM 0.829 11=16-QAM 0.853 12=reserved (auto) All other codes are invalid. <b>EXAMPLE:</b> <0/TMC=6[cr]	TMC= TMC? TMC* TMC#	TMC?	TMC=xx (see Description of Arguments)

Parameter Type	Command (Instruction Code & Qualifier)	Number of Arguments for Command or Response to Query	Description of Arguments (Note that all arguments are ASCII numeric codes from 48 and 57)	Response to Command (Target to Controller)	Query (Instruction Code & Qualifier)	Response to Query (Target to Controller)
Tx Power Level	TPL=	4 bytes	Command or Query. Sets or returns Tx Power Level in the form sxx.x, where: s=sign [- (negative) or + (positive)] xx.x=power value <b>NOTE:</b> Tx Output power level for 950 to 2150 MHz range is from 0 to -40 dBm. <b>EXAMPLE:</b> <0/TPL=-13.4[cr]	TPL= TPL? TPL* TPL#	TPL?	TPL=sxx.x (see Description of Arguments)
Tx Spectrum Invert	TSI=	1 byte	Command or Query. Sets or returns Tx Spectrum invert in the form x, where: 0=normal 1=inverted <b>EXAMPLE:</b> <0/TSI =0[cr]	TSI= TSI? TSI* TSI#	TSI?	TSI=x (see Description of Arguments)
Tx Symbol Rate	TSR=	10 bytes	Command or Query. Sets or returns Tx Symbol Rate in the form dddddd.ddd, where: dddddd.ddd=Tx Symbol Rate in kspss, from 16 kspss to 4.5 Mspss <b>EXAMPLE:</b> <0/TSR=002047.999[cr]	TSR= TSR? TSR* TSR#	TSR?	TSR=dddddd.ddd (see Description of Arguments)
Tx Carrier State	TXO=	1 byte	Command or Query. Sets or returns Tx Carrier State in the form x, where: 0=Off 1=On <b>EXAMPLE:</b> <0/TXO=1[cr]	TXO= TXO? TXO* TXO#	TXO?	TXO=x (see Description of Arguments)
VMS Frequency	N/A	9 bytes	Query only. Returns VMS Frequency in the form xxxx.xxxx, where: xxxx.xxxx=value from 950.0000 to 2150.0000 MHz in 100 Hz increments. <b>EXAMPLE:</b> <0/VFQ?[cr] >0000/VFQ= 2150.0000[cr][lf]	VFQ = VFQ? VFQ*	VFQ?	VFQ =xxxx.xxxx (see Description of Arguments)

### 7.3.3 Receive (Rx) Parameters Commands and Queries

Parameter Type	Command (Instruction Code & Qualifier)	Number of Arguments for Command or Response to Query	Description of Arguments (Note that all arguments are ASCII numeric codes from 48 and 57)	Response to Command (Target to Controller)	Query (Instruction Code & Qualifier)	Response to Query (Target to Controller)
Rx Frequency	RFQ=	10bytes	Command or Query. Sets or returns Rx Terminal Frequency, in MHz, being received from the satellite in the form xxxxx.xxxx, where: xxxxx.xxxx=value from 950.0000 to 65000.0000 MHz (L-Band), in 100 Hz increments. <b>NOTES:</b> <ul style="list-style-type: none"> <li>• If RX LO=00000, then the Rx Frequency is entered as L-Band direct – 950.0000 to 2150.0000;</li> <li>• If RX LO is set in the range of 30000 to 65000, the Rx Frequency is ±Rx LO, and this will be the resulting L-Band frequency the modem will expect to receive.</li> </ul>	RFQ= RFQ? RFQ* RFQ#	RFQ?	RFQ=xxxxx.xxxx (see Description of Arguments)
Rx Gold Code Sequence Index	N/A	6 bytes	Command or Query. <b>NOTE: VALID ONLY IN DVB-S2 MODE</b> Sets or returns Rx Gold Code Sequence Index in the form xxxxxx, where: xxxxxx=value from 0 to 262141 <b>EXAMPLE:</b> <0/RGS=189063[cr]	RGS= RGS? RGS* RGS#	RGS?	RGS=xxxxxx
Rx MODCOD	RMC=	2 bytes	Command or Query. Sets or returns Rx Demodulation in the form xx, where: 0=reserved 1=QPSK 1/4 2=QPSK 1/3 3=QPSK 2/5 4=QPSK 1/2 5=QPSK 3/5 6=QPSK 2/3 7=QPSK 3/4 8=QPSK 4/5 9=QPSK 5/6 10=QPSK 8/9 11=QPSK 9/10 12=8PSK 3/5 13=8PSK 2/3 14=8PSK 3/4 15=8PSK 5/6 16=8PSK 8/9 17=8PSK 9/10	RMC? RMC* RMC#	RMC?	RMC=xx (see Description of Arguments)

Parameter Type	Command (Instruction Code & Qualifier)	Number of Arguments for Command or Response to Query	Description of Arguments (Note that all arguments are ASCII numeric codes from 48 and 57)	Response to Command (Target to Controller)	Query (Instruction Code & Qualifier)	Response to Query (Target to Controller)
Rx MODCOD (cont.)			18=16-APSK 2/3 19=16-APSK 3/4 20=16-APSK 4/5 21=16-APSK 5/6 22=16-APSK 8/9 23=16-APSK 9/10 24=32-APSK 3/4 25=32-APSK 4/5 26=32-APSK 5/6 27=32-APSK 8/9 28=32-APSK 9/10 29=reserved 30=reserved 31=reserved 32=auto (future - ACM only) All other codes are invalid. <b>EXAMPLE:</b> <0/RMC=6[cr]			
Rx Spectrum Invert	N/A	1 byte	Query only. Returns Rx Spectrum Invert in the form x, where: 0=Normal 1=Rx Spectrum Inverted <b>EXAMPLE:</b> <0/RSI?[cr] >0000/RSI=1[cr][lf]	RSI? RSI* RSI#	RSI?	RSI=x (see Description of Arguments)
Rx Symbol Rate	RSR=	10 bytes	Command or Query. Sets or returns Rx Symbol Rate in the form dddddd.ddd, where: dddddd.ddd=value, in ksps, from 16ksps to 4.5Msps <b>EXAMPLE:</b> <0/RSR =002047.999[cr]	RSR= RSR? RSR * RSR #	RSR?	RSR =dddddd.ddd (see Description of Arguments)

### 7.3.4 Demodulator Status Commands and Queries

Parameter Type	Command (Instruction Code & Qualifier)	Number of Arguments for Command or Response to Query	Description of Arguments (Note that all arguments are ASCII numeric codes from 48 and 57)	Response to Command (Target to Controller)	Query (Instruction Code & Qualifier)	Response to Query (Target to Controller)
Rx Es/No	N/A	4 bytes	<p>Query only. Returns the value of Es/No in the form xx.x, where: xx.x=value, in dB, from -1 to -40 (negative sign (-) is implied) in 0.1 dB increments.</p> <p><b>NOTES:</b></p> <ol style="list-style-type: none"> <li>1) The Es/No number correspond to the value that is displayed on HTTP (via the Virtual Front Panel) or SNMP. This value is averaged in the background for the previous 16 values.</li> <li>2) For a faster Es/No reading use REN command.</li> </ol> <p><b>EXAMPLE:</b> &lt;0/EBN?[cr]</p> <p><b>RESPONSE NOTES:</b></p> <ol style="list-style-type: none"> <li>1) Returns 99.9 if demod is unlocked.</li> <li>2) Returns +040 for values greater than -40.0 dB.</li> </ol>	N/A	ESN?	ESN=xxxxx (see Description of Arguments)
Rx Signal Level	N/A	5 bytes	<p>Query only. Returns the value of the Rx signal level, in dBm, in the form xxxxx, where: xxxxx=value, in dBm, from -25 to -55 with a tolerance of <math>\pm 5</math> dBm, in 0.5 dBm increments.</p> <p><b>EXAMPLE:</b> &lt;0/RSL?[cr]</p> <p><b>RESPONSE NOTES:</b></p> <ol style="list-style-type: none"> <li>1) If in the range of -25 to -55 dBm, returns RSL=-xx.y</li> <li>2) If &gt;-25 dBm, returns SL1=GT-25 (GT='greater than')</li> <li>3) If &lt;-55 dBm, returns SL1=LT-55 (LT='less than')</li> </ol>	N/A	RSL?	RSL=xxxxx (see Description of Arguments)



### 7.3.5 Transmit (Tx) BERT Command or Query

Parameter Type	Command (Instruction Code & Qualifier)	Number of Arguments for Command or Response to Query	Description of Arguments (Note that all arguments are ASCII numeric codes from 48 and 57)	Response to Command (Target to Controller)	Query (Instruction Code & Qualifier)	Response to Query (Target to Controller)
Tx BERT State	BTX=	1 byte	Command or Query. Sets or returns Tx BERT State in the form x, where: 0=Off 1=On <b>EXAMPLE:</b> <0/BTX=1[cr]	BTX= BTX? BTX#	BTX?	BTX=x (see Description of Arguments)

### 7.3.6 Receive (Rx) BERT Command or Query

Parameter Type	Command (Instruction Code & Qualifier)	Number of Arguments for Command or Response to Query	Description of Arguments (Note that all arguments are ASCII numeric codes from 48 and 57)	Response to Command (Target to Controller)	Query (Instruction Code & Qualifier)	Response to Query (Target to Controller)
Rx BERT State	BRX=	1 byte	Command or Query Sets or returns Rx BERT state in the form x, where: 0=Off 1=On <b>EXAMPLE:</b> <0/BRX=1[cr]	BRX = BRX? BRX * BRX #	BRX?	BRX=x (see Description of Arguments)

### 7.3.7 BUC (Block Up Converter) Parameters Commands and Queries

Parameter Type	Command (Instruction Code & Qualifier)	Number of Arguments for Command or Response to Query	Description of Arguments (Note that all arguments are ASCII numeric codes from 48 and 57)	Response to Command (Target to Controller)	Query (Instruction Code & Qualifier)	Response to Query (Target to Controller)
BUC Attenuation	ATT=	4 bytes	Command or Query. Sets or returns BUC attenuation level in the form xxxx, where: xxxx=value from -1 to 3000 (in 1/100 dB), in 0.25 dB increments <b>EXAMPLE:</b> <0/ATT=2[cr]	ATT= ATT? ATT* ATT#	ATT?	ATT=xxxx (see Description of Arguments)
BUC FSK Address	BAD=	2 bytes	Command or Query. <b>NOTE: FOR USE ONLY WITH BUCS THAT SUPPORT FSK.</b> Sets or returns BUC Address in the form xx, where: xx=value from 01 to 15 <b>EXAMPLE:</b> <0/BAD=1[cr]	BAD= BAD? BAD* BAD#	BAD?	BAD=xx (see Description of Arguments)

Parameter Type	Command (Instruction Code & Qualifier)	Number of Arguments for Command or Response to Query	Description of Arguments (Note that all arguments are ASCII numeric codes from 48 and 57)	Response to Command (Target to Controller)	Query (Instruction Code & Qualifier)	Response to Query (Target to Controller)
BUC Current High Limit	BCH=	4 bytes	Command or Query. Sets or returns the BUC Current High Limit in the form xxxx, where: xxxx=value from 0 to 4000 mA, in 100 mA increments <b>EXAMPLE:</b> <0/BCH=2300[cr]	BCH= BCH? BCH* BCH#	BCH?	BCH=xxxx (see Description of Arguments)
BUC Current Low Limit	BCL=	4 bytes	Command or Query. Sets or returns the BUC Current Low Limit in the form xxxx, where: xxxx=value from 0 to 4000 mA, in 100 mA increments. <b>EXAMPLE:</b> <0/BCL=1200[cr]	BCL= BCL? BCL* BCL#	BCL?	BCL=xxxx (see Description of Arguments)
BUC DC Current	N/A	4 bytes	Query only. Returns the value of the BUC DC current in the form xxxx, where: xxxx=value from 0 to 9999 mA. <b>EXAMPLE:</b> <0/BDC?[cr] >0000/BDC=9999[cr][lf] <b>NOTE:</b> If not available, response is 0000.	N/A	BDC?	BDC=xxxx (see Description of Arguments)
BUC Voltage	N/A	4 bytes	Query only. Returns the value of the BUC Voltage in the form xx.x, where: xx.x=value from 0 to 64.0 Volts. <b>EXAMPLE:</b> <0/BDV?[cr] >0000/BDV=64.0[cr][lf]	N/A	BDV?	BDV=xx.x (see Description of Arguments)
BUC 10 MHz Reference	BFR=	1 byte	Command or Query. Sets or returns the BUC 10 MHz Reference control in the form x, where: 0=Off 1=On <b>EXAMPLE:</b> <0/BOE=1[cr]	BFR= BFR? BFR* BFR#	BFR?	BFR=x (see Description of Arguments)
BUC RF Output	BOE=	1 byte	Command or Query. Sets or returns the BUC output power enable in the form x, where: 0=Off 1=On <b>EXAMPLE:</b> <0/BFR=1[cr]	BOE= BOE? BOE* BOE#	BOE?	BOE=x (see Description of Arguments)
BUC Output Power	N/A	3 bytes	Query only. Returns the BUC output power level in the form xxx, where: xxx=value from 0 to 999 dBm, in 0.1 dBm increments. <b>EXAMPLE:</b> <0/BOL?[cr] >0000/BOL=45[cr][lf] (returns 4.5 dBm). <b>RESPONSE NOTE:</b> Returns 0 when FSK and BUC power are not enabled.	BOL= BOL? BOL* BOL#	BOL?	BOL=xxx (see Description of Arguments)

Parameter Type	Command (Instruction Code & Qualifier)	Number of Arguments for Command or Response to Query	Description of Arguments (Note that all arguments are ASCII numeric codes from 48 and 57)	Response to Command (Target to Controller)	Query (Instruction Code & Qualifier)	Response to Query (Target to Controller)
BUC PLL Lock	N/A	1 byte	Query only. <b>NOTE: VALID ONLY WHEN THE FSK AND BUC POWER ARE ON.</b> Returns the BUC Phase Lock Loop in the form x, where: 0=Locked 1=Unlocked 9=Not connected <b>EXAMPLE:</b> <0/BPA?[cr] >0000/BPA=1[cr][lf]	N/A	BPA?	BPA=x (see Description of Arguments)
BUC Power Class	N/A	2 bytes	Query only. <b>NOTE: VALID ONLY WHEN THE FSK AND BUC POWER ARE ON.</b> Returns the power level, in watts, for C-Band and Ku-Band in the form xx, where: 1=2 watts 2=4 watts 3=5 watts 4=8 watts 5=10 watts 6=16 watts 7=20 watts 8=25 watts 9=40 watts 10=60 watts <b>EXAMPLE:</b> <0/BPC?[cr] >0000/BPC=10[cr][lf]	N/A	BPC?	BPC=xx (see Description of Arguments)
BUC Power Supply enable	BPS=	1 byte	Command or Query. Sets or returns the BUC Power Supply control in the form x, where: 0=Disable 1=Enable <b>EXAMPLE:</b> <0/BPS=1[cr]	BPS= BPS? BPS* BPS#	BPS?	BPS=x (see Description of Arguments)
BUC Software Version	N/A	2 bytes	Query only. <b>NOTE: VALID ONLY WHEN THE FSK AND BUC POWER ARE ON.</b> Returns the BUC Software Version in the form xx, where: xx=0 or 15 <b>EXAMPLE:</b> <0/BSV?[cr] >0000/BSV=15[cr][lf]	N/A	BSV?	BSV=x (see Description of Arguments)

Parameter Type	Command (Instruction Code & Qualifier)	Number of Arguments for Command or Response to Query	Description of Arguments (Note that all arguments are ASCII numeric codes from 48 and 57)	Response to Command (Target to Controller)	Query (Instruction Code & Qualifier)	Response to Query (Target to Controller)
BUC Power Supply enable	N/A	4 byte	Query only. <b>NOTE: VALID ONLY WHEN THE FSK AND BUC POWER ARE ON.</b> Returns the BUC temperature, in degrees Celsius, in the form x, where: x=value from -127 to 127 <b>EXAMPLE:</b> <0/BUT?[cr] >0000/BUT=15[cr][lf]	BUT= BUT? BUT* BUT#	BUT?	BUT=x (see Description of Arguments)

### 7.3.8 LNB (Low-Noise Block Down Converter) Parameters Commands and Queries

Parameter Type	Command (Instruction Code & Qualifier)	Number of Arguments for Command or Response to Query	Description of Arguments (Note that all arguments are ASCII numeric codes from 48 and 57)	Response to Command (Target to Controller)	Query (Instruction Code & Qualifier)	Response to Query (Target to Controller)
LNB Current	N/A	4 bytes	Query only. Returns the LNB Current value, in mA, in the form xxxx.	N/A	LNC?	LNC=xxxx (see Description of Arguments)
LNB Current High Limit	LNH=	3 bytes	Command or Query. Sets or returns the LNB Current High Limit value in the form xxx, where: xxx=value from 0 to 500 mA. <b>EXAMPLE:</b> <0/LNH=123[cr]	LNH= LNH? LNH* LNH#	LNH?	LNH=xxx (see Description of Arguments)
LNB Current Low Limit	LNL=	3 bytes	Command or Query. Sets or returns the LNB Current Low Limit value in the form xxx, where: xxx= value from 0 to 500 mA. <b>EXAMPLE:</b> <0/LNL=123[cr]	LNL = LNL? LNL * LNL #	LNL?	LNL =xxx (see Description of Arguments)
LNB Reference Enable	LNR=	1 byte	Command or Query. Sets or returns the LNB Reference enable in the form x, where: 0=Disable 1=Enable <b>EXAMPLE:</b> <0/LNR=1[cr]	LNR= LNR? LNR* LNR#	LNR?	LNR=x (see Description of Arguments)
LNB DC Power Control	LPS=	1 byte	Command or Query Sets or returns the LNB DC Power Supply Control in the form x, where: 0=Off 1=13V LNB Voltage 2=18V LNB Voltage 3=24V LNB Voltage <b>EXAMPLE:</b> <0/LPS=3[cr]	LPS= LPS? LPS* LPS#	LPS?	LPS=x (see Description of Arguments)
LNB Voltage	N/A	4 bytes	Query only. Returns the LNB voltage value, in the form xxxx.	N/A	LVO?	LVO=xxxx (see Description of Arguments)

### 7.3.9 Unit Parameters Commands and Queries

Parameter Type	Command (Instruction Code & Qualifier)	Number of Arguments for Command or Response to Query	Description of Arguments (Note that all arguments are ASCII numeric codes from 48 and 57)	Response to Command (Target to Controller)	Query (Instruction Code & Qualifier)	Response to Query (Target to Controller)
Equipment ID	N/A	37 bytes	<p>Query only.</p> <p>Returns the equipment ID and installed options in the form AAAAssssBCDEFGHIJKssssssssssssssssss, where:</p> <p><b>AAAA</b>=The modem model number (default 0840)</p> <p><b>ssss (4 spares)</b>=Installed hardware (default 0000)</p> <p><b>BCDEFGHIJKssssssssssssssssss=Software FAST options, where:</b></p> <p><b>B=Tx Data/Symbol Rate option:</b></p> <p>0=Standard: CCM 16 kbps to 256 kbps            1=CCM 16 kbps to 512bps            2=CCM 16 kbps to 1024 kbps            3=CCM 16 kbps to 2048 kbps            4=CCM 16 kbps to 5 Mbps            5=CCM 16 kbps to 10 Mbps            6=CCM 16 kbps to 15 Mbps            7=ACM 37 ksps to 100 ksps (future)            8=ACM 37 ksps to 200 ksps (future)            9=ACM 37 ksps to 400 ksps (future)            A=ACM 37 ksps to 800 ksps (future)            B=ACM 37 ksps to 1200 ksps (future)            C=ACM 37 ksps to 2400 ksps (future)            D=CCM 37 ksps to 4100 ksps (future)</p> <p><b>C=Rx Data/Symbol Rate option:</b></p> <p>0=Standard: CCM 1 Mbps to 15 Mbps            1=CCM 1 Mbps to 45 Mbps            2=CCM 1 Mbps to 100 Mbps            3=CCM 1 Mbps to 140 Mbps            4=CCM 1 Mbps to 167 Mbps            5=ACM 1 Msps to 5 Msps (future)            6=ACM 1 Msps to 15 Msps (future)            7=ACM 1 Msps to 34 Msps (future)            8=ACM 1 Msps to 47 Msps (future)            9=ACM 1 Msps to 62 Msps (future)</p>	N/A	EID?	EID=AAAAssssBCDEFGHIJKssssssssssssssssss (see Description of Arguments)

Parameter Type	Command (Instruction Code & Qualifier)	Number of Arguments for Command or Response to Query	Description of Arguments (Note that all arguments are ASCII numeric codes from 48 and 57)	Response to Command (Target to Controller)	Query (Instruction Code & Qualifier)	Response to Query (Target to Controller)
Equipment ID (cont.)			<p><b>D=E1 Interface – WAN Adaptation:</b>                      0=None                      1=1 TRX (up to 3 DSO can be selected)                      2=2 TRX (up to 6 DSO can be selected)                      3=3 TRX (up to 9 DSO can be selected)                      4=6 TRX (up to 18 DSO can be selected)                      5=9 TRX (up to 27 DSO can be selected)                      6=9+ TRX / Full E1 (up to 32 DSO can be selected)</p> <p><b>E=Header Compression Tx Data Rate (CCM)/ Symbol Rate (ACM):</b>                      0=None                      1=up to 256 kbps (CCM) / 100 ksps (ACM)                      2=up to 512 kbps (CCM) / 200 ksps (ACM)                      3=up to 1024 kbps (CCM) / 400 ksps (ACM)                      4=up to 2048 kbps (CCM) / 800 ksps (ACM)                      5=up to 5 Mbps (CCM) / 1200 ksps (ACM)                      6=up to 10 Mbps (CCM) / 2400 ksps (ACM)                      7=up to 15 Mbps (CCM) / 4100 ksps (ACM)</p> <p><b>F=Header Decompression Rx Data Rate (CCM)/ Symbol Rate (ACM):</b>                      0=None                      1=up to 15 Mbps (CCM) / 5 Msps (ACM)                      2=up to 45 Mbps (CCM) / 15 Msps (ACM)                      3=up to 100 Mbps (CCM) / 34 Msps (ACM)                      4=up to 140 Mbps (CCM) / 47 Msps (ACM)                      5=up to 167 Mbps (CCM) / 62 Msps (ACM)</p> <p><b>G=Payload Compression Tx Data Rate (CCM)/ Symbol Rate (ACM):</b>                      0=None                      1=up to 256 kbps (CCM) / 100 ksps (ACM)                      2=up to 512 kbps (CCM) / 200 ksps (ACM)                      3=up to 1024 kbps (CCM) / 400 ksps (ACM)                      4=up to 2048 kbps (CCM) / 800 ksps (ACM)                      5=up to 5 Mbps (CCM) / 1200 ksps (ACM)                      6=up to 10 Mbps (CCM) / 2400 ksps (ACM)                      7=up to 15 Mbps (CCM) / 4100 ksps (ACM)</p> <p><b>H=Payload Decompression Rx Data Rate (CCM)/ Symbol Rate (ACM):</b>                      0=None                      1=up to 15 Mbps (CCM) / 5 Msps (ACM)                      2=up to 45 Mbps (CCM) / 15 Msps (ACM)                      3=up to 100 Mbps (CCM) / 34 Msps (ACM)                      4=up to 140 Mbps (CCM) / 47 Msps (ACM)                      5=up to 167 Mbps (CCM) / 62 Msps (ACM)</p>			

Parameter Type	Command (Instruction Code & Qualifier)	Number of Arguments for Command or Response to Query	Description of Arguments (Note that all arguments are ASCII numeric codes from 48 and 57)	Response to Command (Target to Controller)	Query (Instruction Code & Qualifier)	Response to Query (Target to Controller)
Equipment ID (cont.)			<b>I=Quality of Service</b> 0=None 1=Basic QoS (Diffserv + SAR) 2=Advanced QoS (Basic QoS + Rule Based QoS) <b>J=G.702 Clock Extension</b> 0=None 1=Enabled <b>K=Dynamic SCPC</b> 0=None 1=Enabled <b>ssssssssssssssssss (19 spares)</b>			
Faults and Status	N/A	16 bytes	Query only. Returns the current <i>highest-priority</i> fault and status codes for the Unit (hardware), TX Traffic, RX Traffic, and ODUs in the form abcdefxxxxxxxx, where: <b>a=Unit status:</b> 0=No faults 1=+5 V Power Supply fault 2=+12 V Power Supply fault 3=Tx synthesizer unlocked 4=Tx/Rx FPGA PLL unlocked 5=Tx/Rx FPGA load fail 6=Compression FPGA load fail <b>b=Tx Traffic status:</b> 0=Tx traffic OK <b>c=Rx Traffic status:</b> 0=Rx Traffic OK 1=Demodulator unlocked 2=Es/No Alarm <b>d=BUC status/faults:</b> 0=BUC OK 1=BUC Current 2=BUC Voltage <b>e=LNB status/faults:</b> 0=OK, masked or not present 1=LNB current 2=LNB voltage <b>f=Traffic/GE Interface Fault (reports as Unit Fault)</b> 0=OK 1=No Link <b>xxxxxxxx (10 spares)</b>	N/A	FLT?	FLT=abcdefxxxxxxxx (see Description of Arguments)





Parameter Type	Command (Instruction Code & Qualifier)	Number of Arguments for Command or Response to Query	Description of Arguments (Note that all arguments are ASCII numeric codes from 48 and 57)	Response to Command (Target to Controller)	Query (Instruction Code & Qualifier)	Response to Query (Target to Controller)
Geographical Log Information (cont.)			<p>WWWW=hex representation of the weeks field (weeks since 1/6/1980)            SSSSSSS=hex representation of the seconds field (seconds this week)            FFFFFFFF=hex representation of the Tx frequency            BBBBBBBB=hex representation of the Tx symbol rate            M=bitmap for exclusion setting from user, and if locked from the router bit, where:                0=lock bit                1=exclusion bit            AAAA=Latitude from user input            OOOOO=Longitude from user input            NNNNNNNN=Satellite naming string (from 1 to 8 characters)</p>			
Current Software Image	N/A	1 byte	<p>Query Only.            Returns active software image in the form x, where:                1=Bulk Image #1 currently active                2=Bulk Image #2 currently active  <b>EXAMPLE:</b> &lt;0/IMG?[cr]                        &gt;0000/IMG=2[cr][lf]</p>	N/A	IMG?	IMG=x (see Description of Arguments)
Management IP Address	IPA=	18 bytes	<p>Command or Query.            Sets or returns the IP Address and network prefix for the 10/100 BaseT Fast Ethernet FE Management port, in the form xxx.xxx.xxx.xxx/yy, where:                xxx.xxx.xxx.xxx=the IP Address                yy=the network prefix (8-30)  <b>EXAMPLE:</b> &lt;0/IPG=192.168.001.004/24[cr]</p>	IPA= IPA? IPA* IPA#	IPA?	IPA=xx.xxx.xxx.xxx/yy (see Description of Arguments)
Management MAC Address	N/A	12 bytes, alphanumeric	<p>Query only.            Returns the unique FE management port MAC Address in the form xx:xx:xx:xx:xx:xx  <b>EXAMPLE:</b> &lt;0/MAC?[cr]                        &gt;0000/MAC=00:06:B0:00:01:C2[cr][lf]</p>	N/A	MAC?	MAC=xx:xx:xx:xx:xx:xx (see Description of Arguments)
Management Link Configuration	MLC=	1 byte	<p>Command or Query.            Sets or returns 10/100 BaseT Fast Ethernet FE Management port Interface Mode in the form x, where:                0=Auto Negotiate                1=reserved                2=100 Mbps Full Duplex                3=100 Mbps Half Duplex                4=10 Mbps Full Duplex                5=10 Mbps – Half Duplex  <b>EXAMPLE:</b> &lt;0/MLC=3[cr]</p>	MLC = MLC? MLC * MLC #	MLC?	MLC =x (see Description of Arguments)

Parameter Type	Command (Instruction Code & Qualifier)	Number of Arguments for Command or Response to Query	Description of Arguments (Note that all arguments are ASCII numeric codes from 48 and 57)	Response to Command (Target to Controller)	Query (Instruction Code & Qualifier)	Response to Query (Target to Controller)
Actual Negotiated Port Speed	N/A	None	Query only. Returns actual negotiated port speed in the form ab, where: a=GE traffic port negotiated port speed. b=FE management port negotiated port speed. 'a' and 'b' have the following values: 0=Link down 1=100 Full Duplex 2=100 Half Duplex 3=10 Full Duplex 4=10 Half Duplex 5=1000 Full Duplex <b>EXAMPLE:</b> <0/NPS?[cr] >0000/NPS=2[cr][lf]	N/A	NPS?	NPS=ab (see Description of Arguments)
Reported Es/No	N/A	5 bytes	Query Only. Returns the current Es/No of demodulator in the form sxx.x, where: s='+' or '-' (positive or negative sign) xx.x=value from 00.0 to 35.0 dB, in 0.1 dB increments. <b>NOTE:</b> This query provides a fast Es/No reading that is updated in the background 10 times per second, and is also averaged in the background over the previous 16 returned values. <b>RESPONSE NOTES:</b> Returns 999 if demod is unlocked. Returns +35.0 for values greater than 35.0 dB	N/A	REN?	REN=sxx.x (see Description of Arguments)
Software Boot From Slot	SBS=	1 byte	Command or Query. Sets or returns which bulk firmware slot the unit is to boot from, in the form x, where: 0=Latest Firmware (most recent date) 1=Slot#1 Firmware 2=Slot#2 Firmware <b>EXAMPLE:</b> <0/SBS?[cr] >0000/SBS=2[cr][lf]	SBS= SBS? SBS* SBS#	SBS?	SBS=x (see Description of Arguments)
Serial Number	N/A	9 bytes	Query only. Returns the 9-digit unit serial number. <b>EXAMPLE:</b> <0/SNO?[cr] >0000/SNO=123456789[cr][lf]	N/A	SNO?	SNO=xxxxxxxx (see Description of Arguments)
SNMP Read Community	SRC=	16 bytes, characters, no spaces	Command or Query. Sets or returns SNMP Read Community string. <b>EXAMPLE:</b> <0/SRC=public[cr] <b>NOTE: Empty string is not allowed.</b>	SRC = SRC!	SRC?	SRC = x[1..16] (see Description of Arguments)

Parameter Type	Command (Instruction Code & Qualifier)	Number of Arguments for Command or Response to Query	Description of Arguments (Note that all arguments are ASCII numeric codes from 48 and 57)	Response to Command (Target to Controller)	Query (Instruction Code & Qualifier)	Response to Query (Target to Controller)
SNMP Unit Name	SSN=	16 bytes	Command or Query. Sets or returns the SNMP System Name string <b>EXAMPLE:</b> <0/SSN=Remote1[cr] <b>RESPONSE NOTE: If not configured, unit query returns empty string.</b>	SSN = SSN!	SSN?	SSN =x[1..16] (see Description of Arguments)
SNMP Write Community	SWC=	16 bytes, characters, no spaces	Command or Query. Sets or returns SNMP Write Community string. <b>EXAMPLE:</b> <0/SWC=public[cr] <b>NOTE: Empty string is not allowed.</b>	SWC = SWC!	SWC?	SWC = x[1..16] (see Description of Arguments)
Software Revision	N/A	8 bytes	Query only. Returns the revision number for the software installed in the unit, in the form xx.xx.xx.	N/A	SWR?	SWR=xx.xx.xx (see Description of Arguments)
Unit Test Mode	TST=	1 byte	Command or Query. Sets or returns Unit Test Mode in the form x, where: 0=Normal Mode (no test) 1=Tx CW 2=Tx Alternating 1,0 Pattern 3=QPSK PN Pattern <b>EXAMPLE:</b> <0/TST=1[cr]	TST= TST? TST* TST#	TST?	TST=x (see Description of Arguments)

### 7.3.10 Bulk Configuration String Commands

Parameter Type	Command (Instruction Code & Qualifier)	Number of Arguments for Command or Response to Query	Description of Arguments (Note that all arguments are ASCII numeric codes from 48 and 57)	Response to Command (Target to Controller)	Query (Instruction Code & Qualifier)	Response to Query (Target to Controller)
Configuration Load	CLD=	1 byte	Command only. Retrieves a previously stored modem configuration from the Configuration Memory location specified in the form x, where: x=0 to 9. <b>EXAMPLE:</b> <0/CLD=4[cr]	CLD= CLD? CLD* CLD#	N/A	N/A
Configuration Save	CST=	1 byte	Command only. Stores the current modem configuration into the Configuration Memory location specified in the form x, where: x=0 to 9. <b>EXAMPLE:</b> <0/CST=0[cr]	CST= CST? CST* CST#	N/A	N/A

### 7.3.11 Redundancy Commands and Queries

Parameter Type	Command (Instruction Code & Qualifier)	Number of Arguments for Command or Response to Query	Description of Arguments (Note that all arguments are ASCII numeric codes from 48 and 57)	Response to Command (Target to Controller)	Query (Instruction Code & Qualifier)	Response to Query (Target to Controller)
Redundancy State	N/A	1 byte	Query only. Returns the redundancy state of the unit in the form x, where: 0=Offline 1=Online <b>EXAMPLE:</b> <0/RED?[cr] >0000/RED=1[cr][lf]	N/A	RED?	RED=x (see Description of Arguments)
Force 1:1 Switch	FSW=	None	Command only. <b>This command takes no arguments.</b> Forces the unit to toggle the Unit Fail relay to the "fail" state for approximately 500 ms. <b>NOTES:</b> 1) If the unit is a 1:1 pair and it is currently the 'Online' unit, this forces a switchover so the unit will then be in 'Standby' mode 2) The command is always executed by the unit regardless of whether it is stand-alone, in a 1:1 pair, or part of a 1:N system. <b>EXAMPLE:</b> <0/FSW=[cr]	FSW= FSW*	N/A	N/A

### 7.3.12 Vipersat Management System (VMS) Commands and Queries

Parameter Type	Command (Instruction Code & Qualifier)	Number of Arguments for Command or Response to Query	Description of Arguments (Note that all arguments are ASCII numeric codes from 48 and 57)	Response to Command (Target to Controller)	Query (Instruction Code & Qualifier)	Response to Query (Target to Controller)
VMS Network ID	N/A	3 bytes	Query only. Returns the VMS Network ID for the unit in the form xxx, where: xxx=value from 1 to 254 <b>EXAMPLE:</b> <0/VID?[cr] >0000/VID=100[cr][lf]	N/A	VID?	VID=xxx (see Description of Arguments)
VMS Management (UDP) Base port	VMP=	5 bytes	Command or Query. Sets or returns the VMS Management (UDP) Base port for the unit in the form xxxxx, where: xxxxx=value from 49152 to 65534 <b>EXAMPLE:</b> <0/VMP=49155[cr]	VMP= VMP? VMP* VMP#	VMP?	VMP=xxxxx (see Description of Arguments)
VMS Management Multicast address	N/A	15 bytes	Query only. Returns the VMS Multicast IP Address in the form xxx.xxx.xxx.xxx, where: xxx.xxx.xxx.xxx=the IP Address <b>EXAMPLE:</b> <0/VMI?[cr] >0000/VMI=239.001.001.004[cr][lf]	N/A	VMI?	VMI=xxx.xxx.xxx.xxx (see Description of Arguments)

### 7.3.13 Entry Channel Mode (ECM) Commands and Queries

Parameter Type	Command (Instruction Code & Qualifier)	Number of Arguments for Command or Response to Query	Description of Arguments (Note that all arguments are ASCII numeric codes from 48 and 57)	Response to Command (Target to Controller)	Query (Instruction Code & Qualifier)	Response to Query (Target to Controller)
ECM Mode	EMD=	1 byte	Command or Query. Sets or returns ECM Mode in the form x, where: 0=Disable 1=Offline 2=Wait 3=Online <b>EXAMPLE:</b> <0/EMD=0[cr]	EMD= EMD? EMD* EMD#	EMD?	EMD=x (see Description of Arguments)
TX Base Power	EBP=	4 bytes	Command or Query. Sets or returns the Tx Base power in the form sxxx, where: s=sign [- (negative) or + (positive)] xxx=power value from -400 to 0 in 0.1dB increments <b>EXAMPLE:</b> <0/EBP=-252[cr] (sets Tx Base power @ -25.2dB)	EBP= EBP? EBP* EBP#	EBP?	EBP=sxxx (see Description of Arguments)
ECM Multicast Address	EMI=	15 bytes	Command or Query. Sets or returns the IP Address for the VMS Multicast IP in the form xxx.xxx.xxx.xxx, where: xxx.xxx.xxx.xxx=the IP Address <b>EXAMPLE:</b> <0/EMI=192.168.001.004[cr]	EMI= EMI? EMI* EMI#	EMI?	EMI=xxx.xxx.xxx.xxx (see Description of Arguments)
ECM Group ID	EGI=	3 bytes	Command or Query. Sets or returns the ECM Group ID in the form xxx, where: xxx=value from 0 to 255 <b>EXAMPLE:</b> <0/EGI=100[cr]	EGI= EGI? EGI* EGI#	EGI?	EGI=xxx (see Description of Arguments)
ECM Mode Power Hunt Function	EPH=	1 byte	Command or Query. Sets or returns the Power Hunt function when in ECM Mode in the form x, where: 0=Disabled 1=Enabled <b>EXAMPLE:</b> <0/EPH=1[cr]	EPH= EPH? EPH* EPH#	EPH?	EPH=x (see Description of Arguments)
RX LO Frequency	ERF=	5 bytes	Command or Query. Sets or returns the RX LO frequency value in the form xxxxx, where: xxxxx=value in MHz. <b>EXAMPLE:</b> <0/ERF=02300[cr]	ERF= ERF? ERF* ERF#	ERF?	ERF=xxxxx (see Description of Arguments)
TX LO Frequency	ETF=	5 bytes	Command or Query. Sets or returns the TX LO frequency value in the form xxxxx, where: xxxxx=value in MHz <b>EXAMPLE:</b> <0/ETF=02300[cr]	ETF= ETF? ETF* ETF#	ETF?	ETF=xxxxx (see Description of Arguments)

### 7.3.14 Miscellaneous Utility Commands and Queries

Parameter Type	Command (Instruction Code & Qualifier)	Number of Arguments for Command or Response to Query	Description of Arguments (Note that all arguments are ASCII numeric codes from 48 and 57)	Response to Command (Target to Controller)	Query (Instruction Code & Qualifier)	Response to Query (Target to Controller)
Reset DPC power to factory default	DPD=	None	Command only. <b>NOTE: THIS COMMAND TAKES NO ARGUMENTS.</b> Resets Dynamic Power Control and the Entry Channel Mode Tx Base Power value to the factory default. <b>CAUTION – YOU SHOULD QUERY THE ENTRY CHANNEL MODE TX BASE POWER SETTING (&lt;0/EBP=?[cr]) BEFORE USING THIS COMMAND. YOU MAY RESTORE THE ENTRY CHANNEL MODE TX BASE POWER VALUE WITH THE ‘EBP’ COMMAND.</b> <b>EXAMPLE:</b> <0/DPD[cr]	DPD= DPD *	N/A	N/A
Force Reboot	FRB=	N/A	Command only. <b>NOTE: THIS COMMAND TAKES NO ARGUMENTS.</b> Forces the system to reboot. <b>CAUTION – TAKE CARE WHEN USING THIS COMMAND. THE SYSTEM WILL REQUEST NO CONFIRMATION AND WILL NOT WARN YOU BEFORE SYSTEM REBOOT OCCURS.</b> <b>EXAMPLE:</b> <0/FRB[cr]	FRB= FRB*	N/A	N/A
Ping Host	PING[sp]	16 bytes	Command only. Execute PING to send four 64-byte ICMP echo request packets to the host. A valid connection triggers an ICMP response. The host IP Address is in the form xxx.xxx.xxx.xxx. <b>EXAMPLE:</b> <0/PING[sp]xxx.xxx.xxx.xxx[cr]	PING =	N/A	N/A



# Appendix A. REFERENCE DOCUMENTATION

## A.1 Overview



- 1) UNLESS OTHERWISE NOTED – This appendix collectively refers to the Comtech EF Data Advanced VSAT Series ODM-840 Remote Router, ODMR-840 Reduced Form Factor Remote Router, and ODMR-840B Remote Router Board Set as the ODM-840.
- 2) This appendix describes features that may be monitored or controlled by the user, or otherwise processed by the ODM-840. For detailed reading about the operational features of the Advanced VSAT Series group of products, consult the adjunct documentation that is specified in this appendix and is available for download from Comtech EF Data's web site ([www.comtechefdata.com](http://www.comtechefdata.com)).

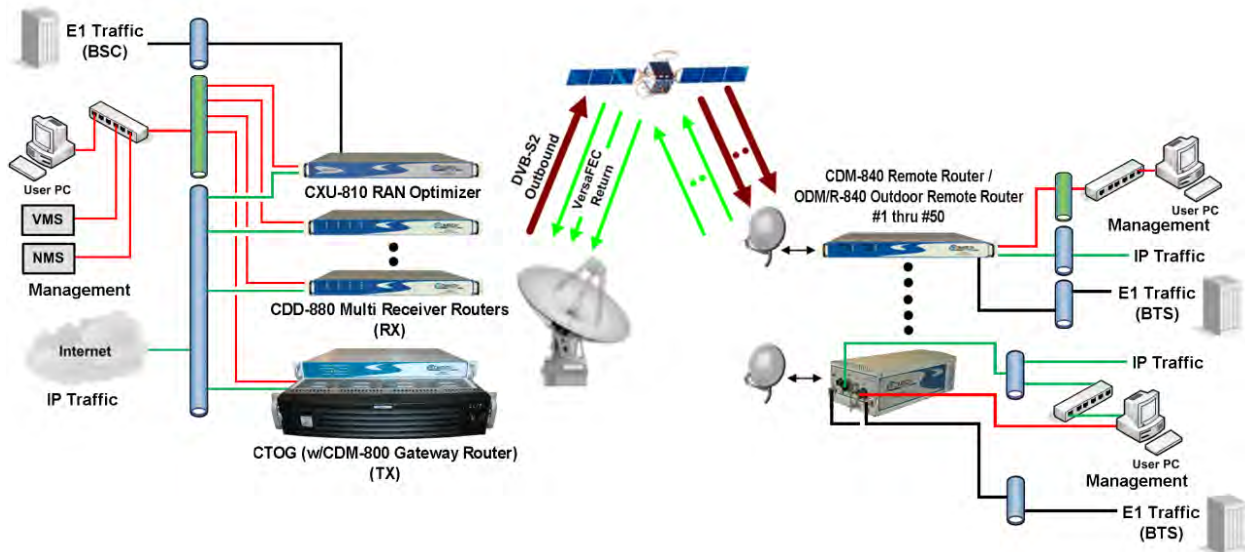

Figure A-1. Advanced VSAT Series Hub and Remote Site Products

---

## A.2 FEC (Forward Error Correction) Options

The method of FEC used among Comtech EF Data's Advanced VSAT series of products differs according to Advanced VSAT Series product. This includes **VersaFEC®**, a family of short-block Low Density Parity Check (LDPC) codes with very low latency. **VersaFEC®** is a patent pending technology wholly owned and developed by Comtech EF Data and Comtech AHA Enterprise Products Group (the **VersaFEC** name is a trademark registered to Comtech AHA).

**For the ODM-840 and CDM-840 Remote Routers:** The FEC method used by the remote site CDM-840 and ODM-840 Remote Routers depends on the direction of signal processing in use:

- **The Rx (receive) side** of the 840 operates with error correction based upon the DVB-S2 standard for QPSK, 8-PSK, 16-APSK and 32-APSK with concatenated LDPC and Bose-Chaudhuri-Hocquenghem (BCH).
- **The Tx (transmit) side** of the 840 uses the **VersaFEC®** family of short-block LDPC codes.



- **Appendix B. FEC (FORWARD ERROR CORRECTION) OPTIONS in this manual.**
- **Appendix B. FEC (FORWARD ERROR CORRECTION) OPTIONS in the Comtech EF Data CDM-840 Remote Router Installation and Operation Manual (CEFD P/N MN-CDM840)**

- **For the CDD-880 Multi Receiver Router:** The hub site CDD-880 Multi Receiver Router uses the **VersaFEC®** family of short-block LDPC codes.



- **Appendix B. FEC (FORWARD ERROR CORRECTION) OPTIONS in the Comtech EF Data CDD-880 Multi Receiver Router Installation and Operation Manual (CEFD P/N MN-CDD880)**

**For the CDM-800 Gateway Router via the CTOG-250 Comtech Traffic Optimization Gateway:** The hub site CDM-800 uses the FEC method based upon the DVB-S2 standard for QPSK, 8-PSK, 16-APSK and 32-APSK with concatenated LDPC and BCH.



- **Appendix B. FEC (FORWARD ERROR CORRECTION) OPTIONS in the CTOG-250 Comtech Traffic Optimization Gateway with CDM-800 Gateway Router Installation and Operation Manual (CEFD P/N MN-CTOG250)**

---

### A.3 ACM/VCM (Adaptive Coding and Modulation / Variable Coding and Modulation) Operation

The VersaFEC® Adaptive Coding and Modulation (ACM) feature is a patents-pending technology owned and developed by Comtech EF Data and Comtech AHA Enterprise Products Group.

ACM allows modulation and code rate (ModCod) to change on a frame-by-frame basis subject to current link conditions. As ACM converts available link margin into increased capacity, average capacity gain of 100% or more is possible. This maximizes each remote's throughput under all conditions which, in turn, maximizes network efficiency and availability. ACM maximizes throughput regardless of link conditions (noise or other impairments, clear sky, rain fade, etc).

Return Link ACM operation is available in the CDM-840 and ODM-840 Remote Routers and in the CDD-880 Multi Receiver Routers. Outbound ACM operation is available in the CDM-800 Gateway Router via the CTOG-250 Comtech Traffic Optimization Gateway.



- **Appendix D. VERSAFEC RETURN LINK ACM (ADAPTIVE CODING AND MODULATION) in this manual.**
- **Appendix D. VERSAFEC RETURN LINK ACM (ADAPTIVE CODING AND MODULATION) in the Comtech EF Data CDM-840 Remote Router Installation and Operation Manual (CEFD P/N MN-CDM840)**
- **Appendix H. VERSAFEC RETURN LINK ACM (ADAPTIVE CODING AND MODULATION) in the Comtech EF Data CDD-880 Multi Receiver Router Installation and Operation Manual (CEFD P/N MN-CDD880)**
- **Appendix E. OUTBOUND ACM (ADAPTIVE CODING AND MODULATION) in the CTOG-250 Comtech Traffic Optimization Gateway with CDM-800 Gateway Router Installation and Operation Manual (CEFD P/N MN-CTOG250)**

---

## A.4 ECM (Entry Channel Mode) Operation

ECM operation is available in the CDM-840 and ODM-840 Remote Routers, and in the CDD-880 Multi Receiver Router. ECM is a feature based on slotted Aloha with random retransmission backoff. It supports multiple carriers through frequency assignments, which provide simplified deployment and scalability.

While a Remote Router is in Entry Channel Mode, it allows the passing of management traffic only – it will not transmit user data traffic. An ECM-enabled Remote Router may remain in the entry channel for an extended period if “online” communications are not required, or if dSCPC (dynamic Single Carrier Per Channel) resources are unavailable. While idle or waiting in the entry channel, the Remote Router sends periodic health status messages to the CTOG-250 and Vipersat Management System (VMS) while it continues to service VMS recovery logic timers.



- **Appendix F. ECM (ENTRY CHANNEL MODE) in this manual.**
- **Appendix G. ECM (ENTRY CHANNEL MODE) in the Comtech EF Data CDM-840 Remote Router Installation and Operation Manual (CEFD P/N MN-CDM840)**
- **Appendix D. ECM (ENTRY CHANNEL MODE) in the Comtech EF Data CDD-880 Multi Receiver Router Installation and Operation Manual (CEFD P/N MN-CDD880)**

---

## A.5 dMesh (VMS Dynamic Mesh) Connectivity

dMesh (Dynamic Mesh) operation is available in the CDM-840 and ODM-840 Remote Routers, and in the CDD-880 Multi Receiver Router. Mesh connectivity minimizes the requirement for communications that are routed through a hub and re-routed back to the remote segments of an Advanced VSAT Network.

Comtech EF Data leverages the concept of Bandwidth-on-Demand (BoD) by taking advantage of Dynamic Single Channel per Carrier (dSCPC) in a mesh environment and adapting it to Comtech EF Data's Advanced VSAT Network platform. This adds dynamic point-to-multipoint SCPC mesh circuits to the network's existing hub and remote link, and DVB-S2 outbound and VersaFEC dSCPC to the return link. Comtech EF Data manages these elements, and provides BoD in a mesh environment through its Vipersat Management System (VMS), the software switching engine behind our Vipersat technology.



- **Appendix K. dMesh (VMS DYNAMIC MESH) SOLUTIONS in this manual.**
- **Appendix L. dMesh (VMS DYNAMIC MESH) SOLUTIONS in the Comtech EF Data CDM-840 Remote Router Installation and Operation Manual (CEFD P/N MN-CDM840)**
- **Appendix F. dMesh (VMS DYNAMIC MESH) SOLUTIONS in the Comtech EF Data CDD-880 Multi Receiver Router Installation and Operation Manual (CEFD P/N MN-CDD880)**
- **Appendix G. dMesh (VMS DYNAMIC MESH) SOLUTIONS in the CTOG-250 Comtech Traffic Optimization Gateway with CDM-800 Gateway Router Installation and Operation Manual (CEFD P/N MN-CTOG250)**

---

## A.6 DPC (VMS Dynamic Power Control) Operation

The DPC (Dynamic Power Control) feature, provided in Comtech EF Data's CDM-840 and ODM-840 Remote Routers, provides a mechanism whereby remote satellite uplinks have their transmit power levels adjusted in order to optimize the receive signal quality as measured by the corresponding demodulator  $E_s/N_0$  (the ratio of energy per symbol to noise density). This optimization process acts to either increase or decrease transmitted signal levels in order to:

- Achieve a minimum level of received  $E_s/N_0$  consistent with providing an error free link or set margin.
- Reduce transmit power where sufficient link margin exists in order to optimize group station uplink saturation and/or satellite transponder power usage reducing costs.
- Increase link availability when margins apply (typically Ku-Band or Ka-Band).
- Maintain proper power backoff to eliminate high power amplifier saturation and carrier distortion.



- **Appendix L. DPC (VMS DYNAMIC POWER CONTROL) in this manual**
- **Appendix M. DPC (VMS DYNAMIC POWER CONTROL) in the Comtech EF Data CDM-840 Remote Router Installation and Operation Manual (CEFD P/N MN-CDM840)**
- **Appendix G. DPC (VMS DYNAMIC POWER CONTROL) in the Comtech EF Data CDD-880 Multi Receiver Router Installation and Operation Manual (CEFD P/N MN-CDD880)**
- **Appendix H. DPC (VMS DYNAMIC POWER CONTROL) in the CTOG-250 Comtech Traffic Optimization Gateway with CDM-800 Gateway Router Installation and Operation Manual (CEFD P/N MN-CTOG250)**

# Appendix B. FEC (FORWARD ERROR CORRECTION) OPTIONS



**UNLESS OTHERWISE NOTED** – This appendix collectively refers to the Comtech EF Data Advanced VSAT Series ODM-840 Remote Router, ODM-840 Remote Router, ODMR-840 Reduced Form Factor Remote Router, and ODMR-840B Remote Router Board Set as the ODM-840.

---

## B.1 FEC Overview

The method of FEC (Forward Error Correction) used by the ODM-840 Remote Router depends on the direction of signal processing in use:

- **The receive (Rx) side** of the ODM-840 operates with error correction based on the DVB-S2 standard for QPSK, 8PSK, 16APSK and 32APSK with concatenated Low Density Parity Code (LDPC) and Bose-Chaudhuri-Hocquenghem (BCH).
- **The transmit (Tx) side** of the ODM-840 uses a family of short-block, very low latency, Low Density Parity Check (LDPC) codes called **VersaFEC**<sup>®</sup>. VersaFEC is ideal for lower data rates that demand the shortest possible latency. It is a patent pending technology wholly owned and developed by Comtech EF Data and Comtech AHA Enterprise Products Group (the VersaFEC name is a trademark registered to Comtech AHA).

---

## B.2 DVB-S2: LDPC and BCH

The DVB-S2 specification defines a generation of performance that boosts throughput by about 30% over DVB-S while using the same amount of bandwidth. The result is coding and modulation that surpasses the capability of concatenated Viterbi and Reed Solomon coding. LDPC and BCH is also a concatenated error correction technique; the LDPC coding scheme features significant, Near-Shannon Bound Performance.

In some cases, LDPC error correction starts flaring toward an error floor as the carrier-to-noise ratio increases. To compensate, BCH error correction follows LDPC and eliminates the flare for any practical range of error rates.

LDPC also functions differently than Viterbi decoding by using iterative decoding. In this process, the data initially corrected by the LDPC decoder is re-encoded and run through the decoder

again to correct additional errors. Through soft decision output from the LDPC decoder and a high-speed processor operating at a rate much higher than the data rate, the iterative process is run as many times as possible before corrected data is finally output to make way for a new block of data entering the decoder.

LDPC also uses interleaving to spread the errors. In contrast, Viterbi error correction operates by passing data through the convolutional error correction process using a single error correction pass.

The error correcting capability of LDPC is enhanced by use of large block sizes. Although large block sizes can increase latency in low bitrate applications (typically less than 2Mbps), this is not a drawback in one-way broadcast applications. Links with LDPC normally operate at multi-megabit data rates where latency effects are minimal. The standard block size for LDPC is 64,800 bits and, for lower data rate applications, a short frame block at 16,800 bits suffers only a small error correcting loss (0.2 to 0.5 dB) compared to the standard block.

## B.2.1 Range of Data Rates



See Sect. 1.4.1 Product Specifications in this manual for the range of available data rates.

## B.2.2 BER, QEF, Eb/No, Es/No Spectral Efficiency, and Occupied Bandwidth

Depending on the operating mode, the DVB standard uses different modes of specifying performance with a unit in IF Loop and Additive White Gaussian Noise (AWGN):

- **DVB-S2 standard: "Quasi Error Free" (QEF)** is defined as "less than one uncorrected error-event per transmission hour at the level of a 5 Mbits/s single TV service decoder", approximately corresponding to a Transport Stream Packet Error Ratio equal to a  $PER < 10^{-7}$  before demultiplexer. A packet is defined as a block of 188-byte MPEG frame size data.
- **Es/No vs. Eb/No:** The DVB-S2 standard commonly refers to the use of Es/No instead of Eb/No. When links operate at a constant symbol rate this is a good method for comparing the performance of different modulation types and code rates.

The relation between the two quantities is given by:

$$E_b/N_o = E_s/N_o - 10_{\log}(\text{Spectral Efficiency})$$



### B.3 VersaFEC (Short-block LDPC)

While LDPC coding represents a significant development in the area of FEC and its performance is exceptional in terms of coding gain, its higher latency is considered disadvantageous in some applications.

Comtech EF Data’s development of LDPC incorporated research into ways to reduce the block size of LDPC (and hence its latency) while preserving the coding gain performance very close to the Shannon bound. The result is development of a set of VersaFEC codes with two distinct purposes:

1. To provide an expanded choice of combinations of modulation and coding that **significantly** reduces latency without compromising coding gain performance.
2. To provide combinations of modulation and coding (**ModCods**), which are suitable for not only Constant Coding and Modulation (**CCM**) applications, but are also the basis for a patent-pending Adaptive Coding and Modulation (**ACM**) system.

VersaFEC offers a sufficient range of code rates and modulation types that optimize link performance under most conditions. **Figure B-1** compares the performance of the VersaFEC codes with the Shannon bound. Note that the chart uses SNR in place of  $E_b/N_0$  – a convention for comparing ACM ModCods. SNR is defined as  $E_b/N_0 + 10_{\log}$  (**Spectral Efficiency**).

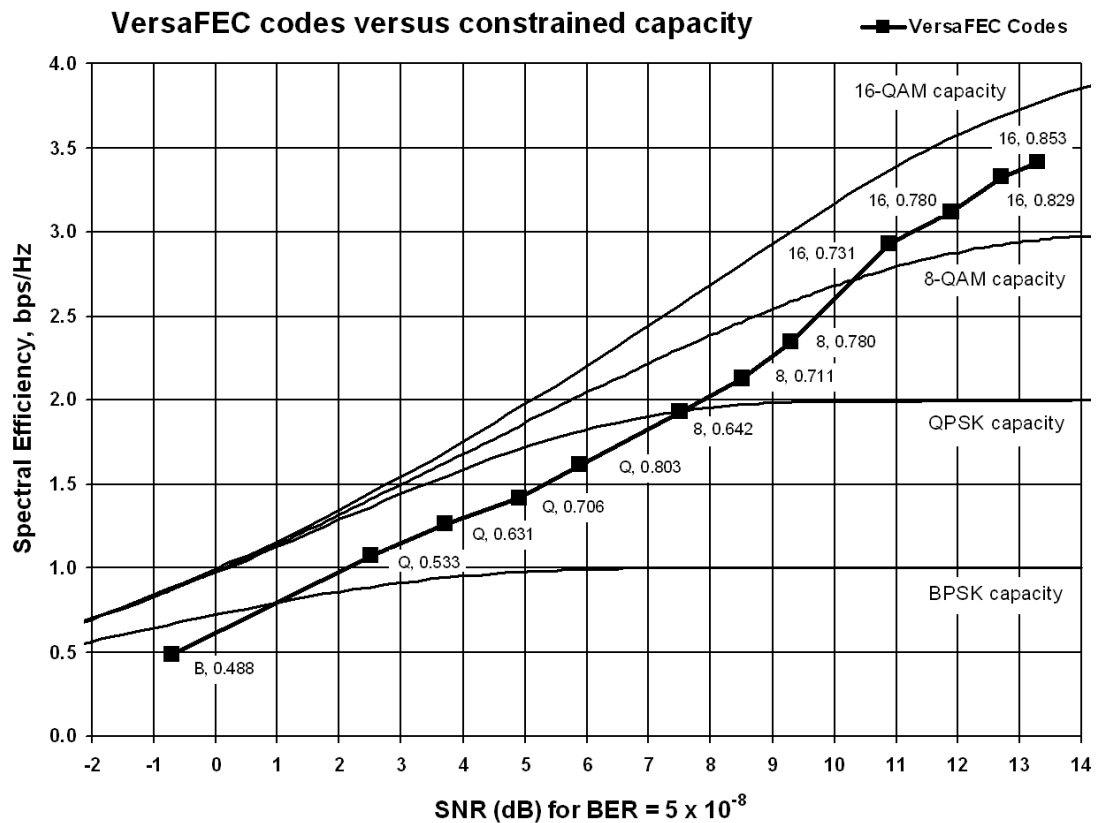

**Figure B-1. The VersaFEC Codes versus Shannon Capacity**

**Table B-1** specifies the 12 modulation types / code rates that comprise the VersaFEC ModCod Set. These chosen modulation types (BPSK, QPSK, 8-QAM and 16-QAM) and code rates afford a continuous progression of performance in terms of both Eb/No and spectral efficiency – essential aspects of a well-engineered ACM system.

**Table B-1. The VersaFEC ModCod Set**

Modulation	Code Rate	Spectral Efficiency, bps/Hz	Block size, kbits	Typical Eb/No, in dB, for BER = $5 \times 10^{-8}$	Latency at 64 kbps, in milliseconds (ms)	Min. Data Rate, CCM mode, in kbps	Max. Data Rate, CCM mode, Mbps
BPSK	0.488	0.49	2	2.4	26	16.00	2.19
QPSK	0.533	1.07	4.1	2.2	53	17.07	4.80
QPSK	0.631	1.26	4.1	2.7	59	20.19	5.67
QPSK	0.706	1.41	4.1	3.4	62	22.577	6.34
QPSK	0.803	1.61	4.1	3.8	66	25.69	7.22
8-QAM	0.642	1.93	6.1	4.6	89	30.83	8.67
8-QAM	0.711	2.13	6.1	5.2	93	34.14	9.60
8-QAM	0.780	2.34	6.1	5.6	97	37.44	10.53
16-QAM	0.731	2.93	8.2	6.3	125	46.80	13.26
16-QAM	0.780	3.12	8.2	7.0	129	49.92	14.04
16-QAM	0.829	3.32	8.2	7.5	131	53.04	14.91
16-QAM	0.853	3.41	8.2	8.0	132	54.60	15.35

### B.3.1 Range of Data Rates



See Sect. 1.4.1 Product Specifications in this manual for the range of available data rates.

---

## B.4 ODM-840 Rx/Tx Error Performance Characteristics

**For Rx DVB-S2 Operation:** Figure B-2 through Figure B-5 show the guaranteed error performance characteristics of the ODM-840 while receiving with Normal frames (64,800 bits), Pilots ON.

**For Tx VersaFEC Operation:** Figure B-6 through Figure B-9 illustrate the guaranteed error performance characteristics of the ODM-840.

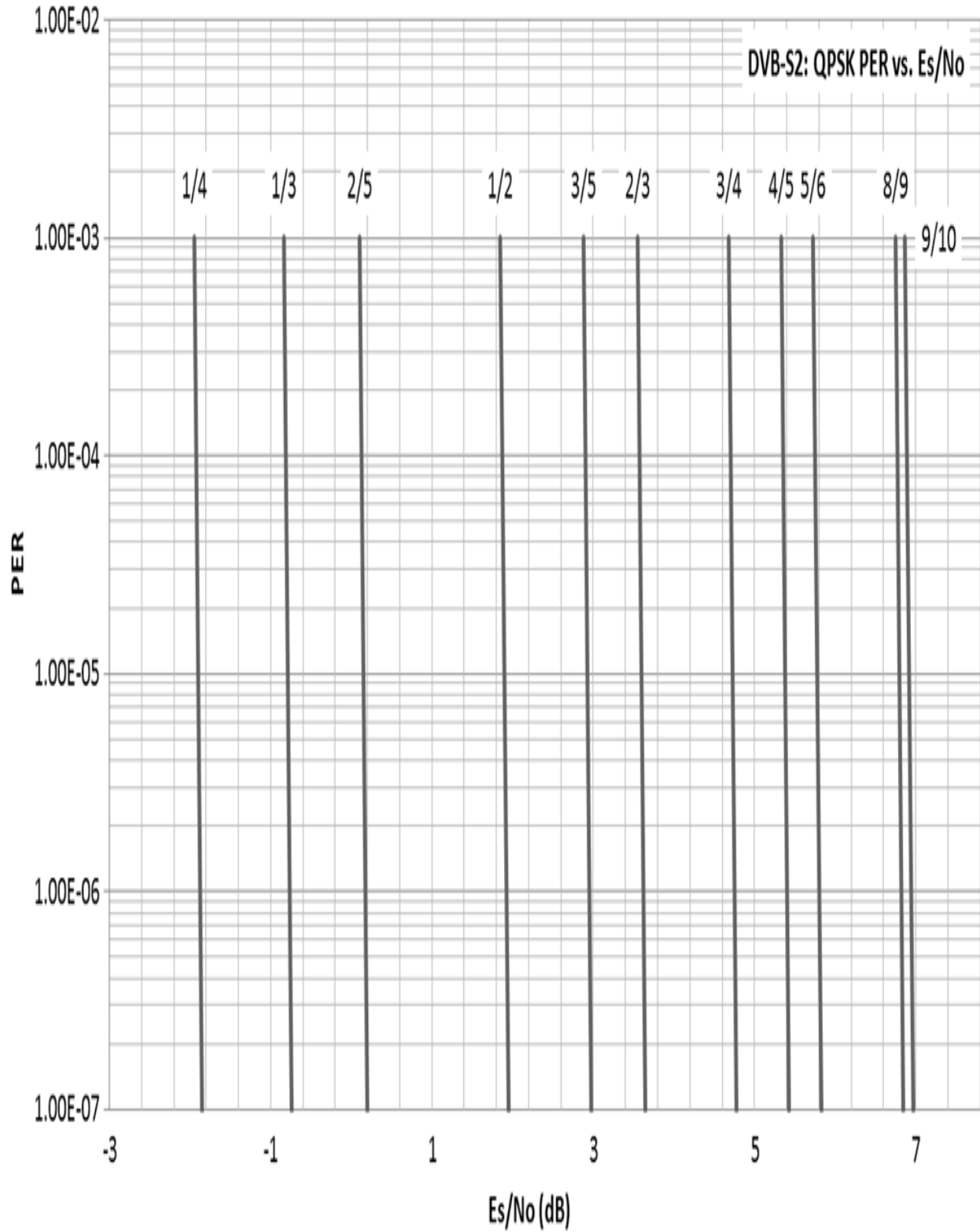

Figure B-2. DVB-S2 QPSK Packet Error Rate versus Es/No

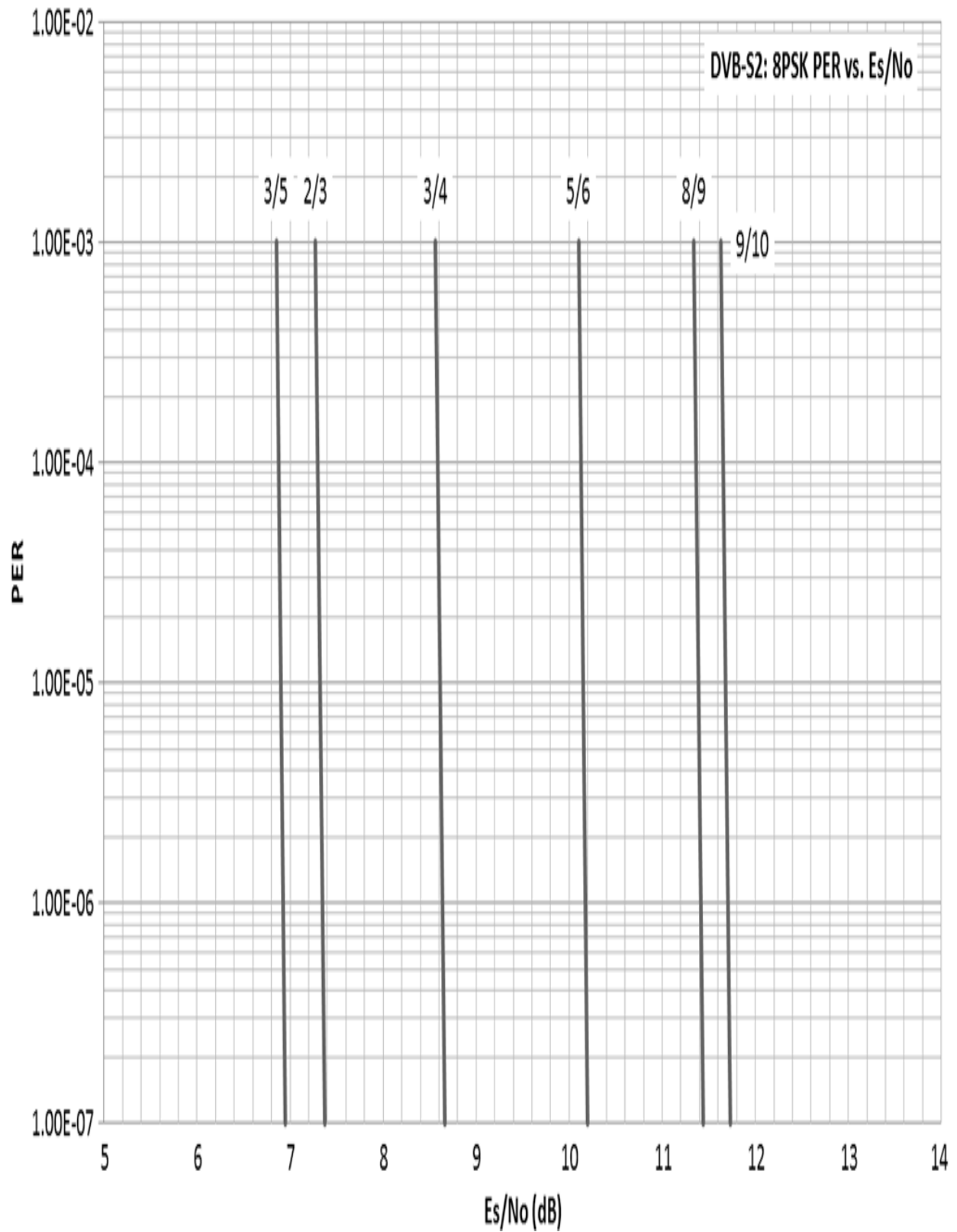

Figure B-3. DVB-S2 8PSK Packet Error Rate versus Es/No

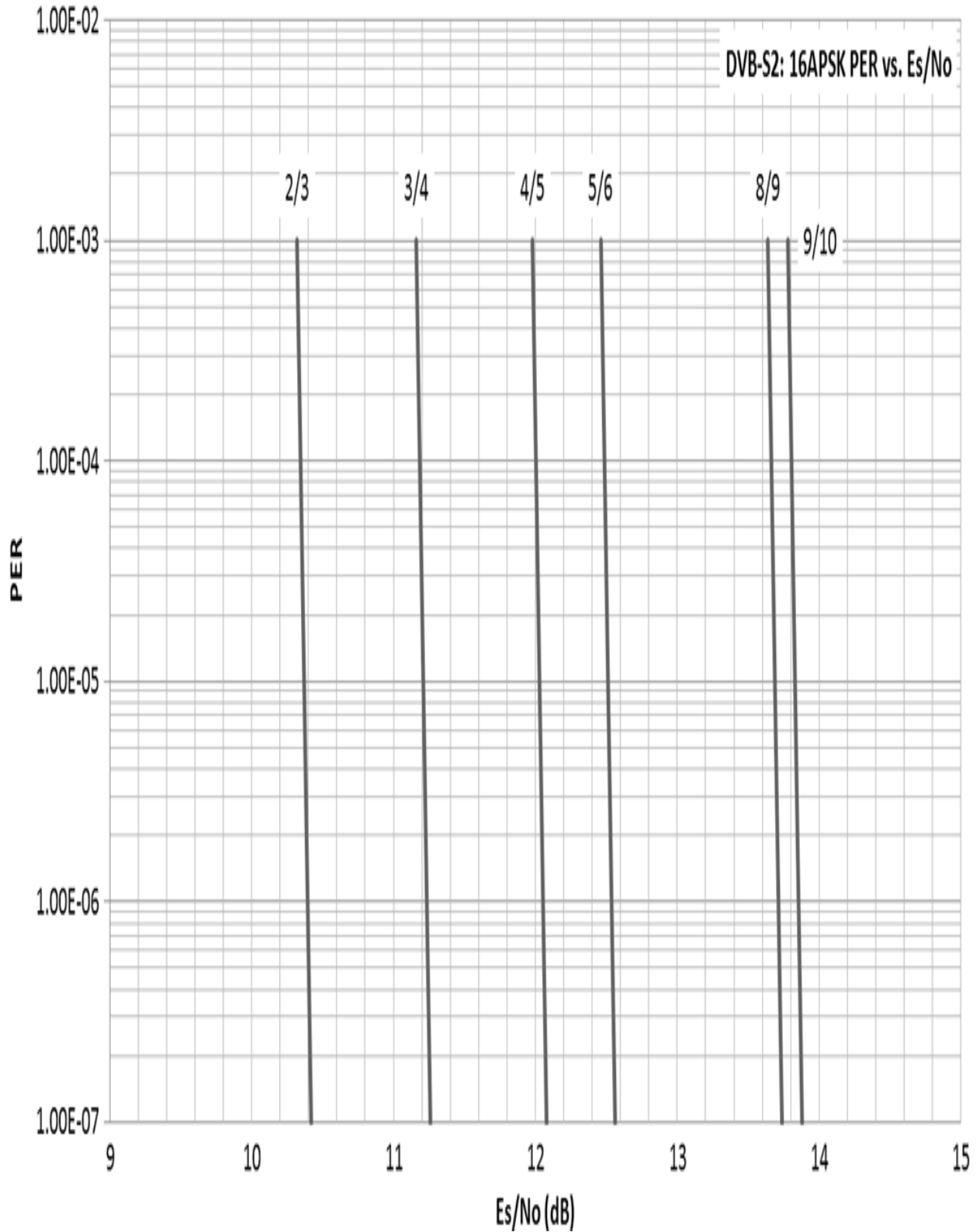

Figure B-4. DVB-S2 16APSK Packet Error Rate versus Es/No

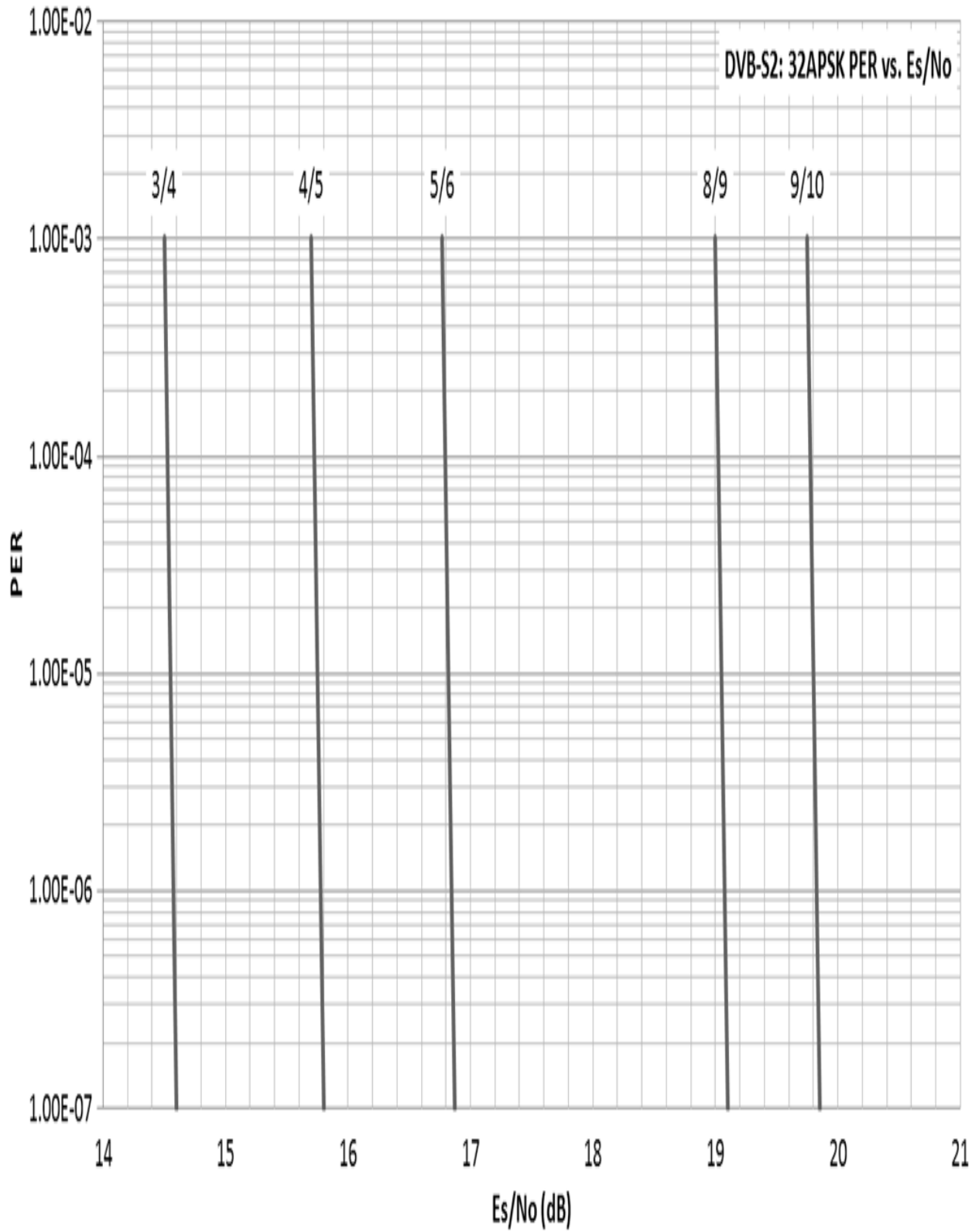

Figure B-5. DVB-S2 32APSK Packet Error Rate versus Es/No

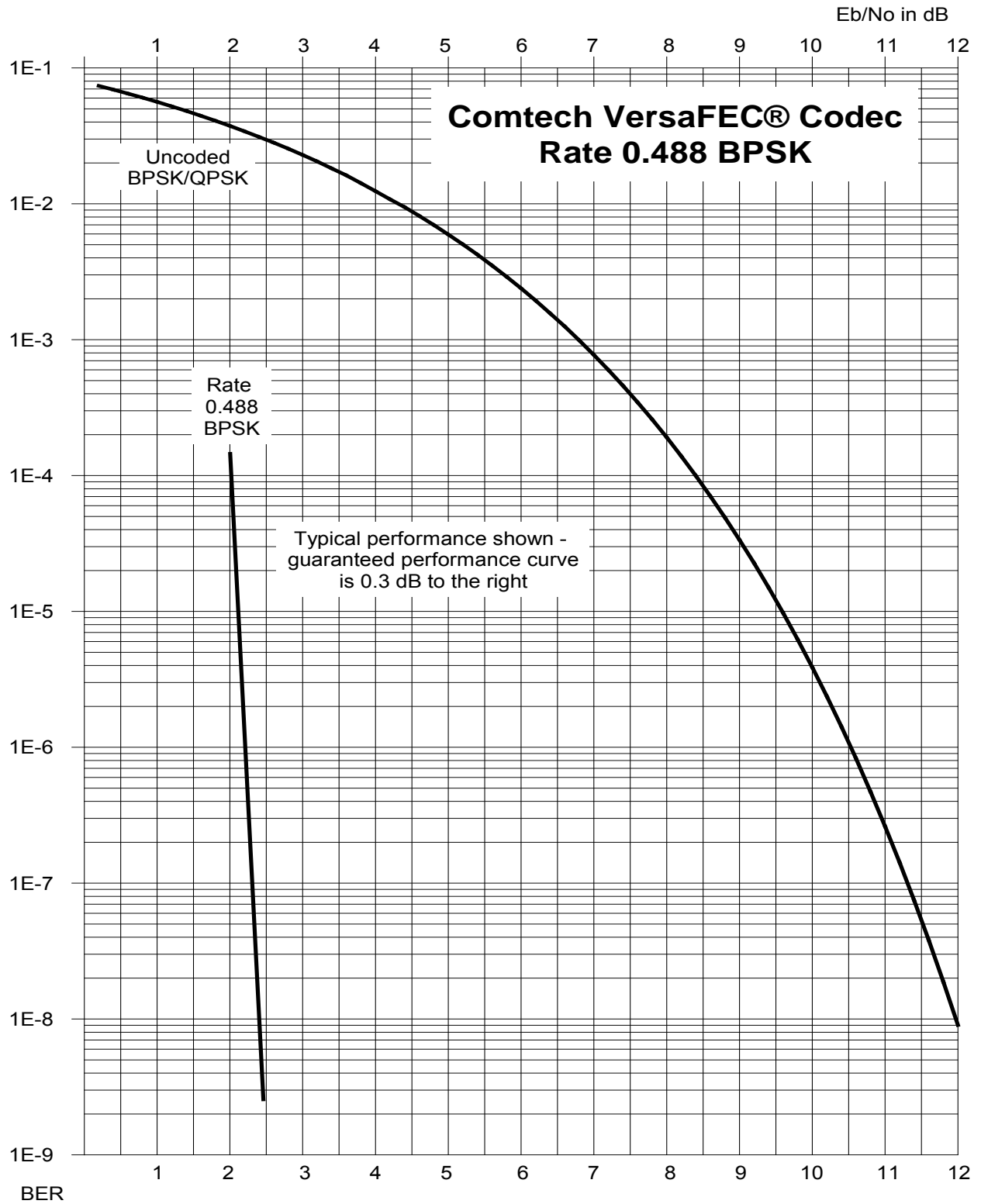

Figure B-6. VersaFEC Codec – BPSK, Rate 0.488

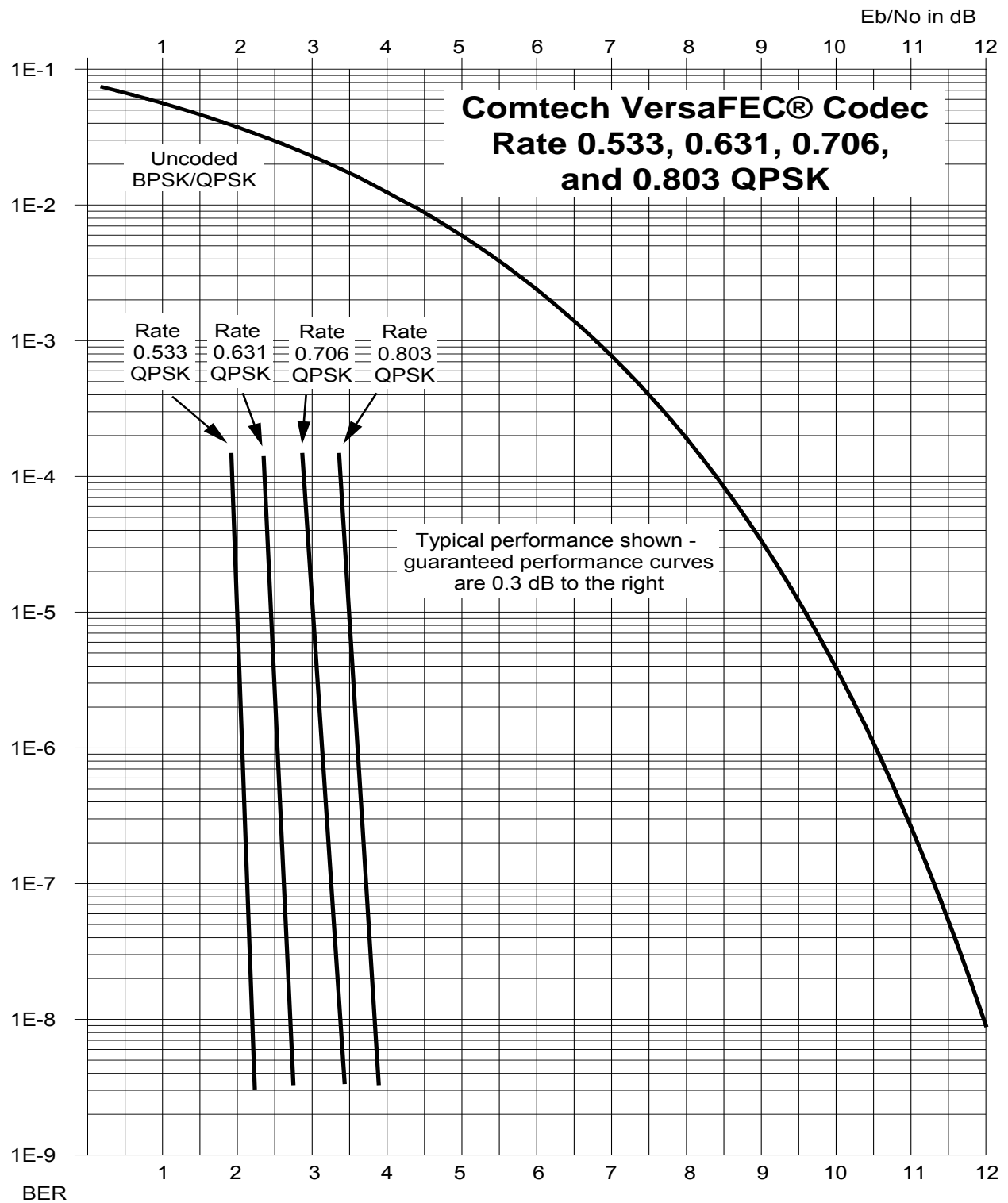

Figure B-7. VersaFEC Codec – QPSK, Rates 0.533, 0.631, 0.706 and 0.803



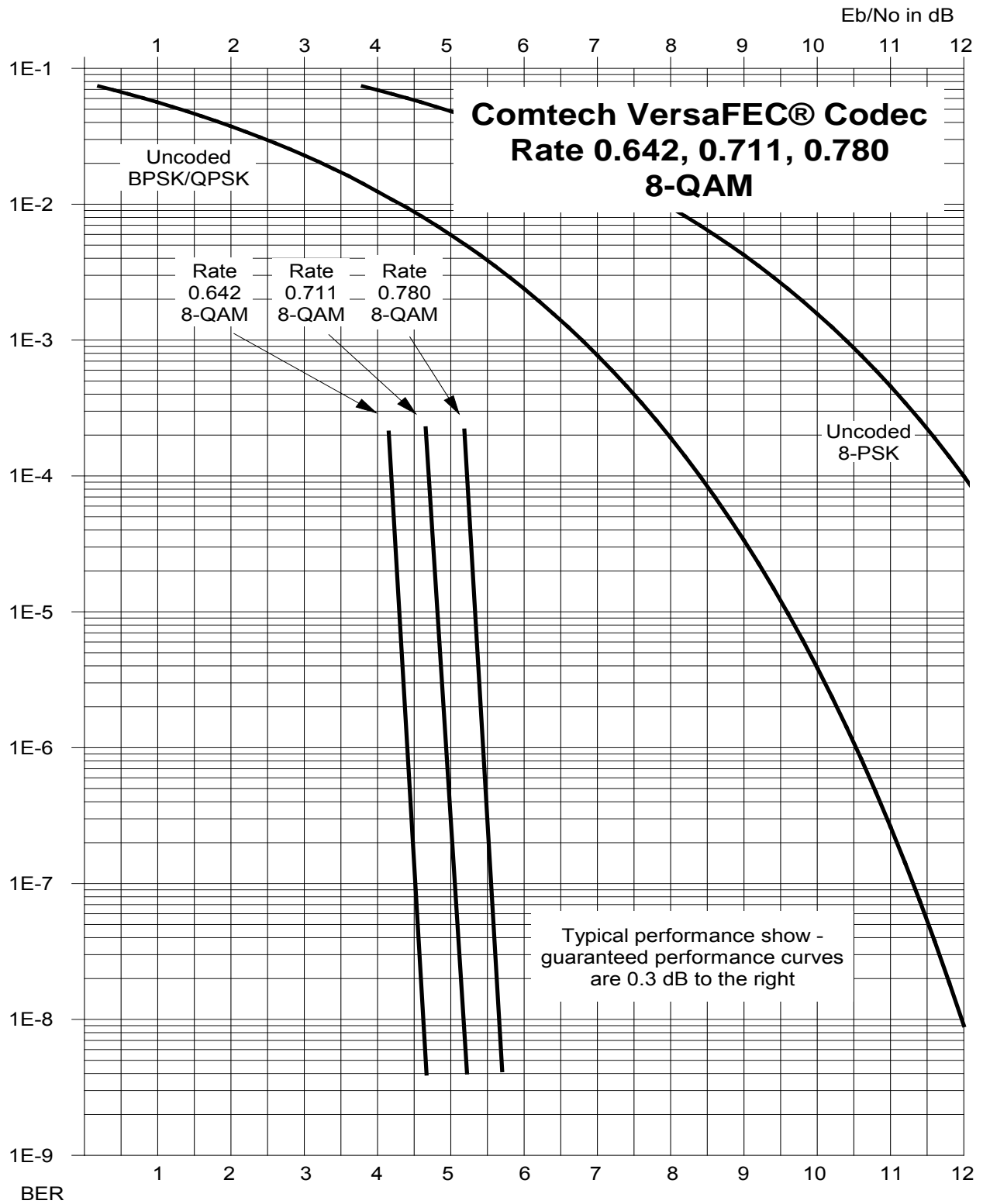
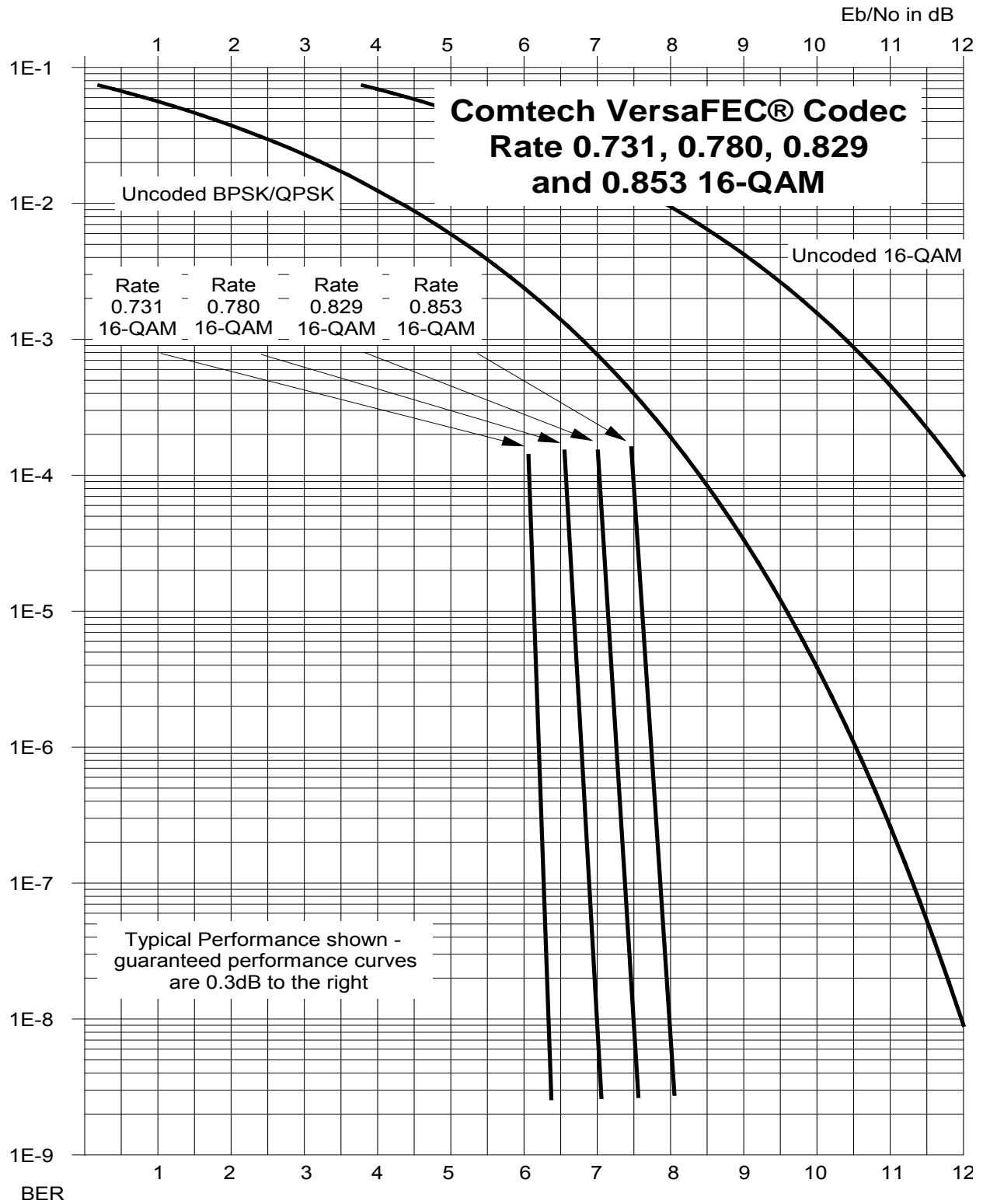

Figure B-8. VersaFEC Codec – 8-QAM, Rates 0.642, 0.711, and 0.780



**Figure B-9. VersaFEC Codec – 16-QAM, Rates 0.731, 0.780, 0.829 and 0.853**

# Appendix C. DATA COLLECTION



**UNLESS OTHERWISE NOTED** – This appendix collectively refers to the ODM-840 Remote Router, ODMR-840 Reduced Form Factor Remote Router, and the ODMR-840B Remote Router Board Set as the ODM-840.

---

## C.1 Data Collection Overview

This appendix provides you with the necessary steps that you must follow to collect diagnostic information from an onsite (field-installed) ODM-840 Remote Router. Should you experience an operational issue (such as degraded performance or loss of IP access), it is mandatory that you collect this diagnostic information from the onsite unit in question before contacting Comtech EF Data Product Support. Comtech EF Data can then use this information to properly investigate and resolve the issue.

The procedures described here require that you use a user-supplied, Windows-based PC, equipped with a user-supplied terminal emulation program (e.g., Tera Term or HyperTerminal), and a custom Serial Adapter Cable<sup>1</sup> to connect your User PC to the ODM-840. See **Sect. C.2** for details about your initial setup requirements.

Once you are properly configured for data collection, you must do these steps, in this order:

1. **Sect. C.3** instructs you to obtain *pre-reboot* information\* from the onsite ODM-840. You will use your User PC terminal emulator to perform a text capture. Use the emulator to access the ODM-840 Serial Interface, for serial communication between the ODM-840 and your User PC. An example of the Serial Interface is shown here (your firmware revision letter and version number may differ):

```
COM1:38400baud - Tera Term VT
File Edit Setup Control Window Help
*****
** COMTECH EF DATA ODM-840 SERIAL INTERFACE **
*****
IP Address = 192.168.1.12/24 Status = Up, 100Mbps (full-duplex)
Firmware = FW-000040BAL, 1.6.2.4
Please type 'help' or '?' for the complete list of supported commands.
Please type 'info' to display the initial information.
Please configure your serial terminal to 'echo' if you can not see the characters typed.
ODM-840>
```

---

<sup>1</sup> See **Sect. C.5** in this appendix for information required to fabricate the Serial Adapter Cable that must be provided by the user for use in this procedure.



**\* You must gather this information while the issue exists. Do not reboot the ODM-840 for any reason until otherwise instructed in this appendix.**

2. Once you gather this initial pre-reboot information, you must reboot the ODM-840 to re-initialize and restore service.
3. Once you collect the pre-reboot Serial Interface text capture file, and after the ODM-840 reboots, **Sect. C.4** instructs you to you must retrieve the modem's onboard data collection files via Ethernet connection, and transfer these files to your User PC:
  - The "**cdm840slot0.xml**" file, which contains the ODM-840 modem configuration settings;
  - The "**log0**", "**log1**", and "**log2**" files, which contain debug information.
  - The "**demodulator.log**" and "**modulator.log**" files, which contain traffic information.
4. Assuming that your User PC is equipped with the appropriate Internet access and e-mail capabilities (Internet Explorer, for example), you must e-mail these pre- and post-reboot files to Comtech EF Data Product Support for evaluation.

## C.2 Initial Setup of Communications Between the ODM-840 and the User PC



**CAUTION** – Obey precautions for handling electrostatic-sensitive devices.

Do these steps, in this order:

1. Connect the custom Serial Adapter Cable between the ODM-840 “**CONSOLE/REDUNDANCY**” port and an available RS-232 serial port on your User PC.
2. Connect a CAT5 Ethernet cable between ODM-840 “**ETHERNET T/M**” port and an available Ethernet network RJ-45 port on your User PC.
3. Use your terminal emulator program to configure the serial port communication and terminal display operation as follows:
  - 38400 bps (Baud Rate)
  - 8 Data Bits
  - 1 Stop Bit
  - Parity = NO
  - Port Flow Control = NONE
  - Display New line Rx/Tx: CR
  - Local Echo = ON
4. After you properly set up communications between your User PC and the ODM-840 Serial Interface, the “->” remote command prompt will display on your terminal emulator.
5. Using Windows Command-line (**Start > Run... > cmd.exe**), create a folder (directory) named “**temp**” (or some other easy-to-remember name) on your User PC for placement of the text capture file, ODM-840 configuration file, and the data collection files:

**Example:** `C:\>md temp`

6. Set your terminal emulator program to capture the Serial Interface session to a text file. Be sure to specify your “temp” folder as the destination path for this text file.



**Read your terminal emulator program User Guide or Help feature for instructions on configuring the serial port communications and for creating and saving text capture files.**

***You are now ready to begin pre-reboot collection of diagnostic information from the ODM-840.***

### C.3 Collect the Pre-Boot Diagnostic Information from the ODM-840



**CAUTION** – This procedure applies only to units running Firmware Version 1.6.2.6 or newer.

Step	To do this:	Type this at the Serial Interface “->” prompt:
1	Confirm that the Interfaces are operational.	-> <b>info</b>
2	Enable diagnostic information display.	->Shift 6 <cr> -> <b>display_diag_info</b>  <i>Note: You may be prompted to press “enter” and press “y &lt;CR&gt;” a few times.</i>
3	Collect log files.	-> <b>LoggerSnapshot</b>  <i>Wait 30 seconds.</i>
4	Enable traffic logger.	->wan_dll_traffic_log_start()  <i>Allow traffic to run for a brief period.</i>
5	Disable traffic logger.	->wan_dll_traffic_log_stop()
6	End the Serial Interface text capture session. Make sure to verify that you save the file to your “temp” folder successfully before rebooting.	->exit  <i>Refer to your terminal emulator program User Guide or Help feature.</i>

**You may now reboot the ODM-840 and proceed to C.4 Collect and Report the Post-Reboot Diagnostic Information from the ODM-840.**

## C.4 Collect and Report the Post-Reboot Diagnostic Information from the ODM-840

Do these steps, in this order:

### 1. “Ping” the ODM-840 to verify the connection and communication:

- a) Set the IP address of the ODM-840 so that it is in the same IP Subnet as the User PC.  
Using the ODM-840 Serial Interface:

- *Connect your Serial Adapter Cable as shown or described previously for initial setup and for collecting information.*
- *Press ‘Enter’ until you see the **ODM-840>** prompt.*
- *Set the IP Address and Subnet using the following command (configure your terminal emulator Local Echo=ON to see what you type):*

```
ODM-840> <0 / IPA=xxx . xxx . xxx . xxx / ss
```

Where **xxx.xxx.xxx.xxx** is the IP Address and **ss** is the number of Subnet bits.

**Example:** `<0 / IPA=192.168.0.1 / 24`

- b) Use Command-line to “ping” the ODM-840.

At the Windows Command-line prompt, type `ping xxx.xxx.xxx.xxx` (where “xxx.xxx.xxx.xxx” is the Traffic/Management IP Address of the ODM-840).

*The results should confirm whether or not the ODM-840 is connected and communicating.*

### 2. Collect the diagnostic and traffic log files from the ODM-840 using File Transfer Protocol (FTP):

Step	To do this:	Type this at the Windows Command-line prompt:
(a)	Change to your User PC “temp” folder.	<code>CMD&gt;cd /temp</code>
(b)	Open the FTP session to the ODM-840.	<code>CMD&gt;ftp xxx.xxx.xxx.xxx</code> (where “xxx.xxx.xxx.xxx” is the ODM-840 Traffic/Management IP Address).
(c)	Log in as Administrator.	(At the prompts, the default username is <code>comtech123</code> , and the default password is <code>comtech123</code> )
(d)	Select binary transfer mode.	<code>ftp&gt;bin</code>
(e)	Change to “tffs” folder.	<code>ftp&gt;cd /tffs</code>

<b>Step</b>	<b>To do this:</b>	<b>Type this at the Windows Command-line prompt:</b>
<b>(f)</b>	Retrieve the ODM-840 configuration file.	<code>ftp&gt;get cdm840slot0.xml</code>
<b>(g)</b>	Collect the diagnostic log files (they may or may not exist).	<code>ftp&gt;get log0</code> <code>ftp&gt;get log1</code> <code>ftp&gt;get log2</code>
<b>(h)</b>	Collect the traffic log files.	<code>ftp&gt;get demodulator.log</code> <code>ftp&gt;get modulator.log</code>
<b>(j)</b>	Terminate the FTP session.	<code>ftp&gt;quit</code>

**3. Forward the data collection files to Comtech EF Data Product Support:**

- a) Prepare your e-mail describing the operational issue, and address it to Comtech EF Data Product Support (esc@comtechefdata.com).
- b) Attach the Serial Interface capture (“cdm840slot0.xml”) and any diagnostic log files (“log0”, “log1”, “log2”) and traffic log files (“demodulator.log”, “modulator.log”) to your e-mail.
- c) Send your e-mail to Comtech EF Data Product Support.

***The Data Collection and Reporting Process is now complete.***



---

## C.5 Serial Adapter Cable Fabrication Specifications Reference



**CAUTION** – This cable will connect your User PC 9-pin serial port to the ODM/R-840 19-pin “CONSOLE/REDUNDANCY” port or to the ODMR-840B Board Set 26-pin “CONSOLE/REDUNDANCY” header/connector.

To ensure proper operation, fabrication of this Serial Adapter Cable requires that :

- You must contact Comtech EF Data Product Support to receive the diagrams and pinout tables required to fabricate your Serial Adapter Cable.
- The European EMC Directive (EN55022, EN50082-1) requires using properly shielded cables for DATA I/O. These cables must be double-shielded from end-to-end, ensuring a continuous ground shield:
  - Your Type ‘D’ connector (at the User PC end) and circular connector (at the OMD/R-840 end) must have back-shells with continuous metallic shielding, and continuous outer shields (either foil or braid, or both). The shields must be bonded to the connector back-shells.

### C.5.1 Customer Assistance

---

#### C.5.1.1 Product Support

For all product support, please call:

+1.240.243.1880

+1.866.472.3963 (toll free USA)

---

#### C.5.1.2 Comtech EF Data Headquarters

<http://www.comtechefdata.com>

Comtech EF Data Corp.

2114 West 7th Street

Tempe, Arizona USA 85281

+1.480.333.2200



# Appendix D. VERSAFEC RETURN LINK ACM (ADAPTIVE CODING AND MODULATION) OPTION



**UNLESS OTHERWISE NOTED** – This appendix collectively refers to the Comtech EF Data Advanced VSAT Series ODM-840 Remote Router, ODMR-840 Reduced Form Factor Remote Router, and ODMR-840B Remote Router Board Set as the ODM-840.

---

## D.1 Functional Overview



**VersaFEC® is a technology that is wholly owned and developed by Comtech EF Data and Comtech AHA Enterprise Products Group. VersaFEC is a registered trademark of Comtech AHA Enterprise Products Group.**

Satellite users have traditionally relied on worst-case link margin to overcome rain fade and other impairments, which leads to significant inefficiencies. ACM (Adaptive Coding and Modulation) allows modulation and code rate (ModCod) to change on a frame-by-frame basis subject to current link conditions. As ACM converts available link margin into increased capacity, average capacity gain of 100% or more is possible. This maximizes each remote's throughput under all conditions which, in turn, maximizes network efficiency and availability.

Advanced VSAT supports ACM in the forward direction as well as the return direction:

- With CCM (Constant Coding and Modulation) systems, severe rain fading can cause the total loss of the link, and zero throughput. ACM keeps the link up (with lower throughput) and can yield much higher system availability.
- ACM turns fade margin into increased link capacity by automatically adapting the modulation type and FEC code rate to give highest possible throughput. Gains of 100% or more are possible, compared to traditional CCM.
- ACM maximizes throughput regardless of link conditions (noise or other impairments, clear sky, rain fade, etc). After initial setup, ACM requires no further user intervention.

You may use ACM with VersaFEC for modems running Firmware Version 1.5.2.X or later.

## D.1.1 Background

ACM has been used for some time in wireless communications, including terrestrial microwave applications and, more recently, over satellite links. The primary function of ACM is to optimize throughput in a wireless data link, by adapting the modulation order used and the Forward Error Correction code rate – both of which directly affect spectral efficiency (expressed in bits per second per Hertz) according to the noise conditions (or other impairments) on the link. Implicit in this concept is that the symbol rate (and power) of the wireless communication system *must remain constant*. This ensures that the bandwidth allocated for a particular link is never exceeded.

Given that the symbol rate does not change, if modulation and coding are changed, the data rate must therefore be modified. This is expressed in the simple equation:

$$\text{Symbol rate} = \text{bit rate} / (\text{modulation order} * \text{code rate})$$

For example, for Rate 3/4 QPSK (where modulation order = 2):

$$\text{Symbol rate} = \text{bit rate} * 0.666$$

Re-arranging:

$$\text{Bit rate} = \text{symbol rate} * \text{modulation order} * \text{code rate}$$

So, in changing to a higher modulation order or code rate, the bit rate is **increased**, and in changing to a lower modulation order or code rate, the bit rate is **reduced**. However, some important factors must be considered:

- **The digital communications system must be able to tolerate a change in bit rate.**

Synchronous serial interfaces (such as G.703 E1, which operated at a fixed data rate of 2.048 Mbps) are totally unsuitable in a scheme where data rate is changing. The only practical application for this scheme is a packet-based scheme that will tolerate a change in data rate, and which has mechanisms within its protocols to recognize when increased or reduced bandwidth is available. The best example of this is Ethernet, and this discussion is limited to schemes that employ it. The ODM-840 supports both IP and E1 (internally packetized) operation with ACM. The ODMR-840 Reduced Form Factor Remote Router and ODMR-840B Remote Router Board Set support IP operation with ACM only.

- **The bit rate cannot be changed arbitrarily.**

The link noise conditions, described in terms of Eb/No or SNR, must be able to support reliable communications for the given modulation order and code rate. This is a key point as, in fact, *the link SNR is the input that drives the adaptation*.

## D.2 VersaFEC ACM

VersaFEC covers a family of 18 short-block LDPC ModCods, specifically designed for low latency and ACM applications. However, the VersaFEC codes are equally well suited to Constant Coding and Modulation (CCM) applications.

The shortest possible LDPC codes that give performance at or very close to DVB-S2 with significantly reduced latency in comparison.

The family of VersaFEC short-block LDPC codes is presented in **Table D-1**. The modulation types include BPSK, QPSK, 8-QAM, and 16-QAM. This table shows that, in order to maintain a constant number of symbols per block, the block size in bits (data + parity) must necessarily change, depending on both the modulation type (which affects the number of bits per symbol) and the code rate. For VersaFEC, the block size varies between 2k and 8.2k bits. At worst, therefore, the VersaFEC codes are 50% shorter than the ‘short’ DVB-S2 codes.

**Table D-1. The VersaFEC ModCod set**

Modulation	Code Rate	Spectral efficiency, bps/Hz	Block size, kbits	Typical Eb/No, in dB, for BER = $5 \times 10^{-8}$	Latency at 64 kbps, in Milliseconds (ms)	Min. Data Rate, CCM mode (kbps)	Max. Data Rate, CCM mode (Mbps)
BPSK	0.488	0.49	2	2.4	26	16.00	2.19
QPSK	0.533	1.07	4.1	2.2	53	17.07	4.80
QPSK	0.631	1.26	4.1	2.7	59	20.19	5.67
QPSK	0.706	1.41	4.1	3.4	62	22.577	6.34
QPSK	0.803	1.61	4.1	3.8	66	25.69	7.22
8-QAM	0.642	1.93	6.1	4.6	89	30.83	8.67
8-QAM	0.711	2.13	6.1	5.2	93	34.14	9.60
8-QAM	0.780	2.34	6.1	5.6	97	37.44	10.53
16-QAM	0.731	2.93	8.2	6.3	125	46.80	13.26
16-QAM	0.780	3.12	8.2	7.0	129	49.92	14.04
16-QAM	0.829	3.32	8.2	7.5	131	53.04	14.91
16-QAM	0.853	3.41	8.2	8.0	132	54.60	15.35

The VersaFEC codes compared with the Shannon bound are shown in **Figure D-1**. It can be seen that the performance of VersaFEC at or near the DVB-S2 performance with 16 kbit blocks.

Note that SNR is used in place of Eb/No, a convention for comparing ACM ModCods. SNR is defined as  $\text{Eb/No} + 10_{\log}(\text{Spectral Efficiency})$ .

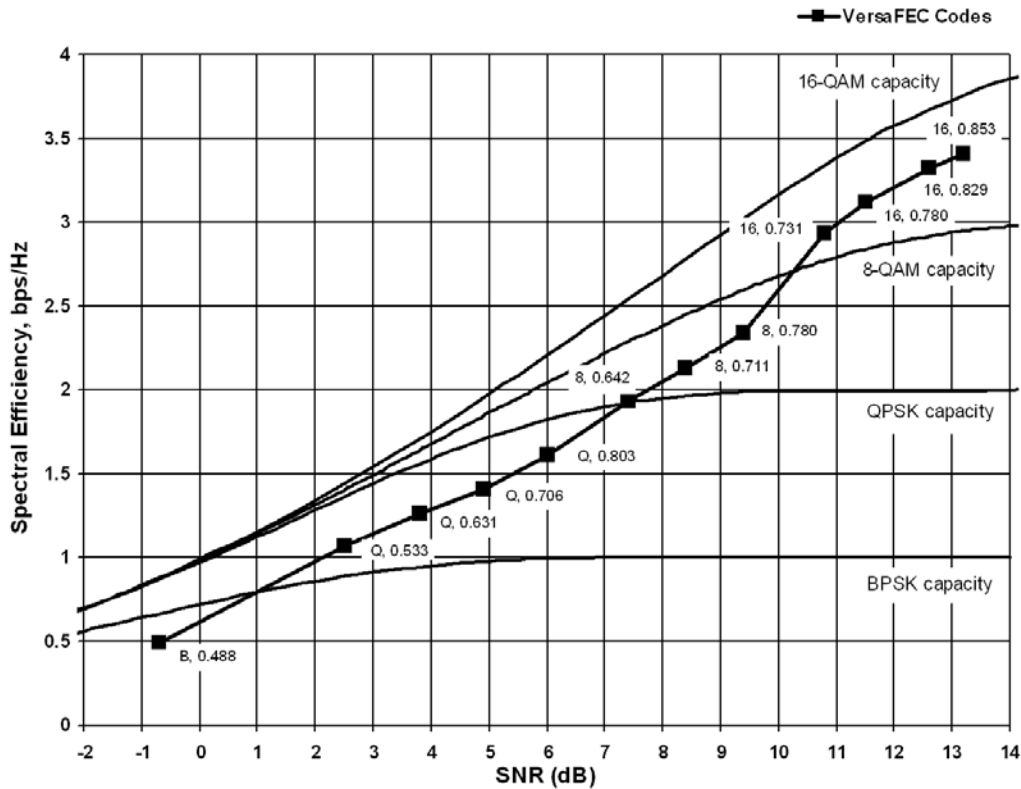

Figure D-1. VersaFEC Codes vs. Constrained Capacity

### D.2.1 VersaFEC ACM Latency

Examining the data in **Table D-2**, latency for each ModCod is shown for the example of VersaFEC ACM at a fixed 100 ksymbols/second rate. Of particular note is that even though the ModCods span a 7:1 variation in throughput, the latency is only varying between 25 and 34 milliseconds. In the example shown the worst-case latency for this ACM scheme is 34 milliseconds.

**Table D-2. VersaFEC Implementation of ACM – 100 ksymbols/sec Example Case**

ModCod	Modulation	Code Rate	Spectral efficiency, bps/Hz	Bit rate (throughput)	Minimum Latency, In milliseconds
00	BPSK	0.488	0.49	49 kbps	34
01	QPSK	0.533	1.07	107 kbps	32
02	QPSK	0.631	1.26	126 kbps	30
03	QPSK	0.706	1.41	141 kbps	28
04	QPSK	0.803	1.61	161 kbps	26
05	8-QAM	0.642	1.93	193 kbps	30
06	8-QAM	0.711	2.13	213 kbps	28
07	8-QAM	0.780	2.34	234 kbps	27
08	16-QAM	0.731	2.93	293 kbps	27
09	16-QAM	0.780	3.12	312 kbps	26
10	16-QAM	0.829	3.32	332 kbps	25
11	16-QAM	0.853	3.41	341 kbps	25
<b>OVERALL SYSTEM LATENCY = Worst-case ModCod (ModCod0)</b> <b>Latency = 34 milliseconds, NOT INCLUDING WAN BUFFER OR SATELLITE PATH</b>					

---

## D.3 ODM-840 VersaFEC ACM Operation

The ODM-840 provides several means for configuring VersaFEC ACM operation via Remote Product Control with a user-supplied PC:

- ODM-840 HTTP (Web Server) Interface using a compatible Web browser.
- Ethernet-based Simple Network Management Protocol (SNMP) using a Network Management System (NMS) and Management Information Base (MIB) File Browser.



**COMTECH EF DATA RECOMMENDS USE OF THE SERIAL-BASED REMOTE CONTROL INTERFACE AND THE ETHERNET-BASED SNMP INTERFACE ONLY FOR ADVANCED USERS. COMTECH EF DATA STRONGLY ENCOURAGES USE OF THE ODM-840 HTTP INTERFACE FOR MONITOR AND CONTROL (M&C) OF THE ODM-840.**

**THE HTTP INTERFACE FIGURES AS FEATURED THROUGHOUT THIS APPENDIX ARE INTENDED FOR USER REFERENCE ONLY AND ARE SUBJECT TO CHANGE. THE FIRMWARE INFORMATION (I.E., REVISION LETTERS, VERSION NUMBERS, ETC.) AS DISPLAYED MAY DIFFER FROM YOUR SETUP.**

### D.3.1 VersaFEC ACM Operation Using the HTTP Interfaces



**YOU MAY PROCEED WITH ETHERNET-BASED REMOTE PRODUCT MANAGEMENT (HTTP OR SNMP), ASSUMING THAT:**

- **YOUR ODM-840 IS OPERATING WITH THE LATEST VERSION FIRMWARE FILES.**
- **YOUR ODM-840 IS CONNECTED TO A USER-SUPPLIED, WINDOWS-BASED PC AS FOLLOWS:**
  - **THE PC SERIAL PORT IS CONNECTED TO THE ODM-840 ‘CONSOLE/ REDUNDANCY’ PORT WITH A USER-SUPPLIED 19-PIN-TO-9-PIN ADAPTER SERIAL CABLE.**
  - **THE PC ETHERNET PORT IS CONNECTED TO THE ODM-840 ‘ETHERNET T/M’ ETHERNET PORT WITH A USER-SUPPLIED HUB, SWITCH, OR DIRECT WEATHERPROOF ETHERNET CABLE CONNECTION.**
  - **THE PC IS RUNNING A TERMINAL EMULATION PROGRAM (FOR OPERATION OF THE ODM-840 SERIAL INTERFACE) AND A COMPATIBLE WEB BROWSER (FOR OPERATION OF THE HTTP INTERFACE).**
- **YOU HAVE NOTED THE ODM-840 MANAGEMENT IP ADDRESS USING THE ODM-840 SERIAL INTERFACE.**

**Figure D-2** shows the ODM-840 HTTP Interface “splash” page, and the menu tree for accessing VersaFEC ACM operation. Page functionality that is not specific to VersaFEC ACM operation appears dimmed.

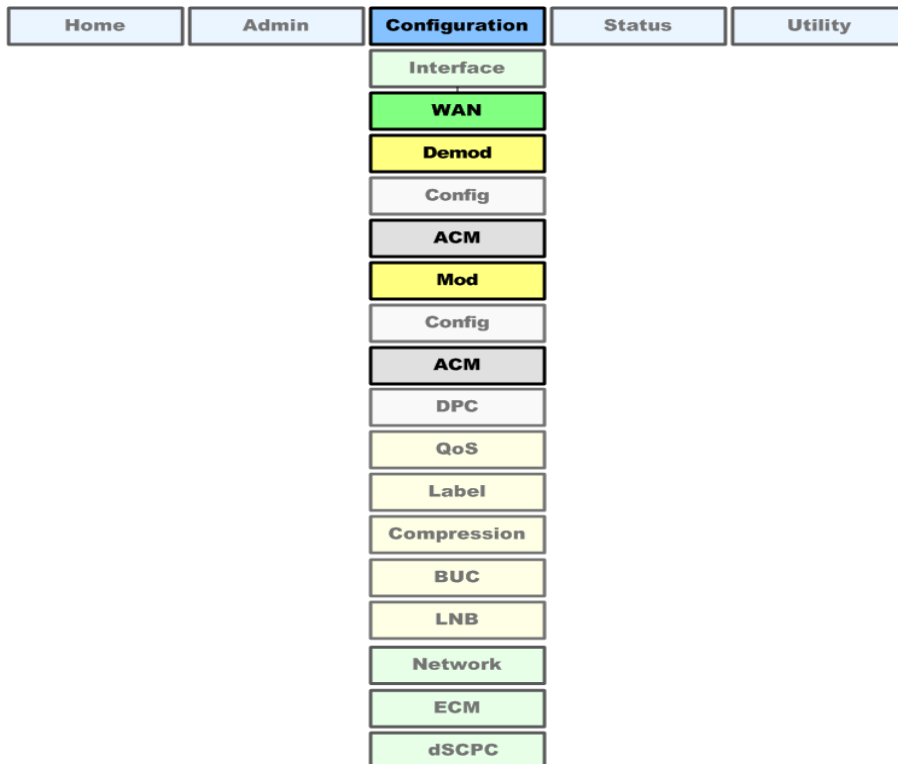
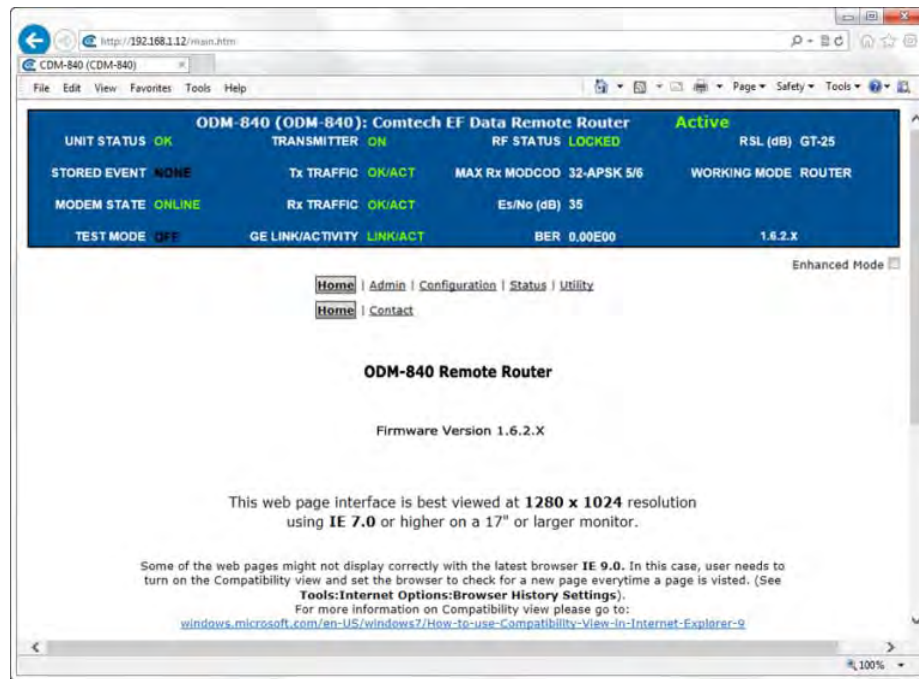

**Figure D-2. ODM-840 HTTP Interface and Menu Tree – VersaFEC ACM Operation (FW Ver. 1.6.2.X)**



Do these steps to configure the ODM-840 for VersaFEC ACM operation from the specified HTTP Interfaces:

1. Configure a route from the CDD-880 to the CTOG-250 for the Management IP Address of the ODM-840.



- Comtech EF Data CTOG-250 Comtech Traffic Optimization Gateway with CDM-800 Gateway Router Installation and Operation Manual (CEFD P/N MN-CTOG250)

- Comtech EF Data CDD-880 Multi Receiver Router Installation and Operation Manual (CEFD P/N MN-CDD880)

2. Use the ODM-840 HTTP Interface ‘Configuration | WAN | Mod | ACM’ page (Figure D-3) to configure the Target Es/No margin and the Max ModCod.



Sect. 6.3.3.2.2 Configuration | WAN | Mod | ACM (Adaptive Coding and Modulation) in Chapter 6. ETHERNET-BASED REMOTE PRODUCT MANAGEMENT



- 1) The recommended value for the target margin in order to maintain the link at Ku is at least 0.5db.
- 2) The Max ModCod should be configured to the maximum ModCod that this terminal can achieve given the link budget, antenna, look angle, BUC power, etc.

3. Enable ACM.

The screenshot shows the 'Tx ACM Configuration' page. At the top, there are navigation tabs: Home, Admin, Configuration (selected), Status, and Utility. Under 'Configuration', there are sub-tabs: Interface, WAN (selected), Network, ECM, dSCPC, and MEO. Under 'WAN', there are further sub-tabs: Demod, Mod (selected), QoS, Label, Compression, BUC, and LNB. Under 'Mod', there are sub-tabs: Config (selected), ACM, and DPC.

The main content area is titled 'Tx ACM Configuration' and contains the following fields:

- ACM Enable:
- Max MODCOD:
- Target Es/No Margin:
- 

Below this is the 'Tx ACM Status (List all 880s)' section, which contains a table with the following data:

Seconds since last LQRM:	Max Seconds since last LQRM:	IP Source of last LQRM:	Last Reported Es/No:	Current Modcod	Current DataRate
ACM Disabled	13313	Not yet received first msg	Unlocked	QPSK .706 (3)	200 Kbps

At the bottom is the 'Tx ACM Events' section, which contains a table with the following data:

Date	Time	Reported Es/No	New ModCod	New Tx DataRate	880 IP
		0	0	0	0.0.0.0

There is a 'Clear ACM Events' button at the bottom right of the events table.

Figure D-3. ODM-840 HTTP Interface – Configuration | WAN | Mod | ACM Page

### D.3.2 Troubleshooting

Confirm that the "Seconds since last LQRM" is being reset to '0' periodically, which indicates that the LQRMs are being received by the ODM-840.

Confirm that the proper Management IP Address appears in the CDD\_880 Demod screen. It will be populated automatically.

### D.3.3 Monitoring ACM Performance

The ODM-840 provides several ways to determine the current state of the ACM system.

The current Tx and Rx ModCod, along with the Remote SNR, are displayed on the 'Configuration | WAN | Mod | ACM' page (Figure D-3). The SNR displays values between -3.0 dB and +25.0 dB, with a resolution of 0.1 dB. This page updates dynamically, so if a ModCod changes, the parameters are refreshed.

This information is also available through the SNMP interface.

If you have access to an Oscilloscope in X-Y mode, the ODM-840 rear panel 'ALARMS' connector provides analog voltages to monitor the constellation.

### D.3.4 ModCod Switch Points

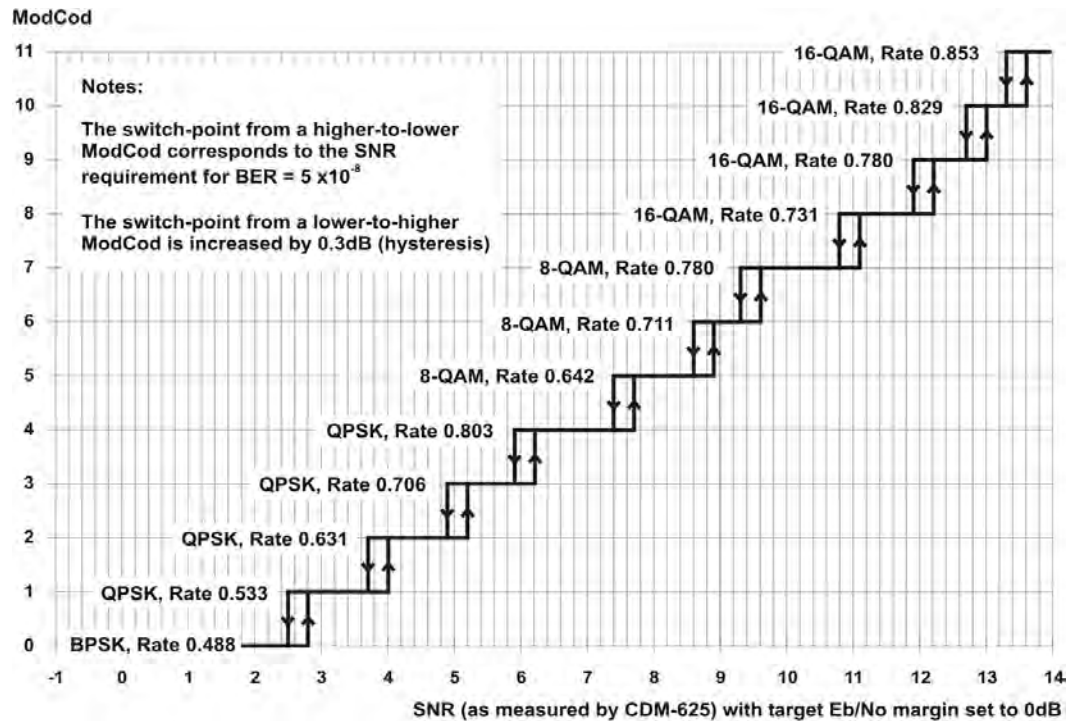

Figure D-4. ODM-840 – ACM ModCod Switch Points

The Figure D-4 graph shows the switch points with the Target Eb/No margin set to 0dB. However, the switch points can be moved (increased) by configuring the Target Eb/No margin

parameter, which can vary from 0 to 4.5 dB, in 0.5dB steps. In a fading environment, it is strongly recommended to add sufficient margin to maintain an adequate link quality (and to maintain demod lock) during the interval between the Eb/No degrading and the ACM controller responding by lowering the ModCod. See **Section D.5 Notes and Recommendations**.

## D.4 ACM Congestion Control

When the ACM controller switches from a lower to a higher ModCod the bandwidth of the Ethernet link is instantaneously increased. This is not a problem, and the link will adapt to push more packets/second through the link.

Conversely, when the ACM controller switches from a higher to a lower ModCod the bandwidth of the Ethernet link is instantaneously reduced. Unless the FIFO in the WAN encapsulator is configured to be very large, the FIFO will tend to overflow, and packets will be lost before the network recognizes that there is congestion, and reduces the rate at which packets are sent.

In order to mitigate packet loss when bandwidth is reduced, the ODM-840 ACM system incorporates a method for congestion control that is illustrated in **Figure D-5**.

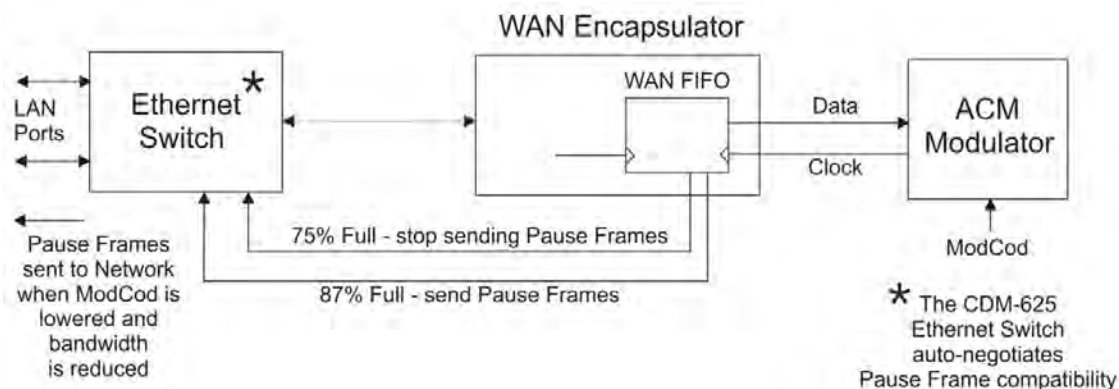

**Figure D-5. ODM-840 – ACM Congestion Control**

The WAN FIFO (the size of which is configurable in the IP Switch setup) produces two control signals that enable and disable the sending of Ethernet **Pause Frames**. A Pause Frame is an Ethernet frame designed to implement flow control at the MAC layer. A switch supporting 802.3x can send a Pause Frame (with Pause time set to 0xFFFF) to force the link partner to stop sending data. Devices use the Auto-Negotiation protocol to discover the Pause Frame capabilities of the device at the other end of the link.

In the diagram it can be seen that when the WAN FIFO reaches a fill state of 87%, it signals the Ethernet Switch to send Pause frames back to the LAN to inhibit the sending of further data. The Pause Frames continue to be sent until the FIFO fill state has reduced to 75%. At this point, normal operation is resumed by sending a Pause Frame with Pause time set to 0x0000. This mechanism has been shown to be very effective at mitigating packet loss when the ACM controller reduces bandwidth.

---

## D.5 Notes and Recommendations

- VersaFEC is for point-to-point applications. It is required that both directions on the link run in ACM mode, although the symbol rates do not need to be equal. For VersaFEC, if you wish to constrain one direction to run in CCM, simply set the Min and Max ModCod to be equal.
- ACM constitutes a closed-loop control system and it should be remembered that like all control systems, the speed at which the system can react is governed by a number of factors, including the time taken to estimate SNR to the required accuracy, and the transport delay over the satellite. Realistically, it can cope with fading and other link impairments that do not exceed 1 dB/second (more if Target Eb/No margin is increased).
- The ACM controller algorithm that resides in the ODM-840 modem exhibits a different response depending on whether SNR is increasing or decreasing. If the SNR is improving, the ACM controller switches to higher ModCods sequentially until the highest possible ModCod has been reached. It may, therefore, take several seconds for the link to reach maximum throughput. Conversely, if SNR is degrading rapidly (in a fade) then it can change, if needed, directly from ModCod11 to ModCod0 (VersaFEC example). This gives the fastest possible response and helps keep the link intact under fast fading events.
- While ACM can do remarkable things, the fundamentals still apply. Don't expect the demod to run at a 16-ARY ModCod if the SNR instantaneously drops to 0 dB – the demod will lose lock and the system will recover by switching to ModCod0 (if so configured, in VersaFEC).



**To achieve the most robust link performance, Comtech EF Data strongly recommends that you set the Minimum ModCod to 0 (the ModCod of last resort), and set the Unlock Action to 'Go to minimum ModCod'.**

- For VersaFEC running in ACM mode the demodulator is performing *blind acquisition* – meaning that it has no *a priori* knowledge of the modulation type or code rate. For this reason the demodulator acquisition time will be slower than in CCM mode. However, the acquisition time is typically under 1 second for all symbol rates and noise conditions.
- Running the ACM link with the Target Eb/No Margin set to 0 dB will give the best utilization of link power, but in conditions of fast fading may cause demod unlock events, or highly degraded BER just prior to the switch to a lower ModCod. In order to mitigate this, we recommend a Target Eb/No Margin of at least 0.5 dB – more if the fading events are particularly severe and/or frequent.
- The BER versus Eb/No performance of the ModCods is identical to the VersaFEC CCM modes described in **Appendix B. FEC (FORWARD ERROR CORRECTION) OPTIONS**.
- To achieve minimum latency, set the WAN buffer to the smallest practical value This will depend on how well the connected equipment implements rate limiting, and the variation in IP packet size. The default setting is 20 ms.
- All IP features that are available in the ODM-840 (VLAN, QoS, etc) are available while in ACM mode.

- ACM maximizes throughput not only when Eb/No varies due to atmospheric conditions, but will also mitigate the effects of other impairments, such as antenna pointing error, excessive phase noise and certain types of interference. However, rapidly fluctuating impairments (i.e., ~ less than 1 second) such as scintillation at low antenna look-angles at C-band will generally not be improved by ACM.

## D.6 Summary of Specifications

<b>System type</b>		Adaptive Coding and Modulation, using BPSK, QPSK, 8-QAM , 16-QAM and VersaFEC short-block LDPC coding - total of 12 ModCods			
<b>Symbol Rate Range</b>		16 ksp/s to 4500 ksp/s			
<b>Interface</b>		10/100 BaseT Ethernet, with auto-negotiated Congestion Control			
<b>Remote SNR reporting</b>		Automatically reported from remote modem – built in function at the physical layer – requires no additional overhead			
<b>Max span of data rate</b>		7:1 over range of adaptation			
<b>Switch point (decreasing SNR)</b>		Corresponds to SNR (Es/No) that gives BER = $5 \times 10^{-8}$ (margin set to 0 dB)			
<b>Switch point hysteresis</b>		0.3 dB			
<b>Max fading rate</b>		Approximately 1 dB/second (higher if Target Eb/No margin > 1 dB)			
<b>Max ModCod update rate</b>		1 update every 2 seconds			
<b>Configurable parameters</b>		<ul style="list-style-type: none"> <li>• Minimum and Maximum ModCod (ModCod0 through ModCod11)</li> <li>• Remote Demod Unlock Action: Maintain current ModCod Go to minimum ModCod</li> <li>• Target SNR margin (0 to 4.5 dB, 0.5 dB steps)</li> </ul>			
<b>System latency</b>		34 milliseconds max (not including WAN buffer, or satellite path)			
<b>Monitored parameters</b>		<ul style="list-style-type: none"> <li>• Tx and Rx ModCods</li> <li>• Local and Remote SNR (-3.0 dB to +22.0 dB, 0.1 dB resolution, +/- 0.5 dB accuracy)</li> <li>• Config and monitor menus displaying data rate, modulation and code rate update dynamically with ModCod</li> </ul>			
Modulation	Code Rate	Spectral Efficiency, bps/Hz	Typical Eb/No, for BER = $5 \times 10^{-8}$ (dB)	Min. Data Rate, ACM mode (kbps)	Max. Data Rate, ACM mode (Mbps)
BPSK	0.488	0.49	2.4	16.00	2.19
QPSK	0.533	1.07	2.2	17.07	4.80
QPSK	0.631	1.26	2.7	20.19	5.67
QPSK	0.706	1.41	3.4	22.577	6.34
QPSK	0.803	1.61	3.8	25.69	7.22
8-QAM	0.642	1.93	4.6	30.83	8.67
8-QAM	0.711	2.13	5.2	34.14	9.60
8-QAM	0.780	2.34	5.6	37.44	10.53
16-QAM	0.731	2.93	6.5	46.80	13.26
16-QAM	0.780	3.12	7.1	49.92	14.04
16-QAM	0.829	3.32	7.7	53.04	14.91
16-QAM	0.853	3.41	8.1	54.60	15.35



# Appendix E. CARRIER ID (DVB-CID METACARRIER<sup>®</sup>)



**UNLESS OTHERWISE NOTED – This appendix collectively refers to the Comtech EF Data Advanced VSAT Series ODM-840 Remote Router, ODMR-840 Reduced Form Factor Remote Router, and ODMR-840B Remote Router Board Set as the ODM-840.**

---

## E.1 Functional Overview

The ODM-840 Remote Router incorporates a patent-pending carrier identification (CID) technique that uses MetaCarrier<sup>®</sup> spread spectrum technology to embed a unique carrier identification sequence for the transmitted carrier.

The ODM-840 with MetaCarrier<sup>®</sup> is used in tandem with the Comtech EF Data MCDD-100 MetaCarrier<sup>®</sup> Detection Device to provide a complete MetaCarrier embedding and decoding solution.

Since the initial release of this technology, the European Telecommunications Standards Institute (ETSI) has adopted a modified version of Comtech's original scheme, which is defined in **ETSI TS 103 129 – Digital Video Broadcasting (DVB) Framing Structure, Channel Coding and Modulation of a Carrier Identification System (DVB-CID) for Satellite Transmission**. ODM-840s running Firmware Version 1.6.2.4 or later fully comply with this new ETSI specification.

### E.1.1 About MetaCarrier

The DVB-CID (MetaCarrier) concept employs a low-speed data sequence containing identifying information about a host carrier that is spread using Direct Sequence Spread Spectrum (DSSS), and then combined, at a low power level, directly underneath that host carrier. The composite signal therefore carries its own embedded identification. The power level and bandwidth of the MetaCarrier is sufficiently low that it is completely hidden below the host carrier, and has minimal effect on system  $E_b/N_0$  (approximately 0.1 dB).

DVB-CID operates independent of the modulation and Forward Error Correction (FEC) rate of the host carrier. In configurations where the carrier is encrypted or uses cryptographic technologies, the information carried in the DVB-CID is not affected.

Traditionally, the method for identifying an interfering carrier involves using a geo-location system that, in turn, uses the phase offset from an adjacent satellite to triangulate the approximate location on the surface of the earth where the interference is being generated. While such “tried-and-true” geo-locating methods have proven beneficial to satellite operators and service providers, they are nevertheless imprecise. For example, to find the exact location of the transmission source in a densely populated area, you must dispatch a helicopter equipped with a feed horn and spectrum analyzer; the time and cost associated with such methods are significant.

By contrast, Comtech EF Data’s DVB-CID provides you with the interference source’s identification information within seconds. Once you identify the offending carrier, you may then contact the uplinking station and request that the station shut down or otherwise remove the identified transmission from service.

## E.1.2 Functional Description

In a typical network, there can be many ODM-840s with DVB-CID, and one (or more) MCDD-100 MetaCarrier Detection Devices to verify the presence of the DVB-CID on each carrier. In an interference situation, the MCDD-100 may be used to decode the DVB-CID of an interfering carrier that may not be part of one’s own transmission network, as long as the interfering carrier has an embedded DVB-CID.

The ODM-840 creates a composite carrier by first sizing the appropriate MetaCarrier, and then by adding the spread spectrum CID (at a highly reduced power spectral density compared with that of the host carrier).

The size of the MetaCarrier is determined based purely on symbol rate and is totally independent of modulation and coding, resulting in two (2) discrete sizes of MetaCarrier being combined with the host carrier. The MetaCarrier parameters are shown below:

Host Carrier	Embedded DVB-CID MetaCarrier	DVB-CID psd relative to host carrier psd
128 ksps to < 512 ksps	112 kchips per sec *	-27.5 dB
512 ksps to < 2048 ksps	224 kchips per sec	-27.5 dB
2048 ksps to < 4096 ksps	224 kchips per sec	-24.5 dB
4096 ksps to < 8192 ksps	224 kchips per sec	-21.5 dB
8192 ksps to 12500 ksps	224 kchips per sec	-18.5 dB

\*kchips per sec refers to the direct sequence spread spectrum chipping rate

As shown here, the bandwidth of the host carrier is always wider than the MetaCarrier, the worst case being a 112 kcps MetaCarrier underneath a 128 ksps host carrier. In all configurations of the combined carrier, the MetaCarrier raises the transmission power less than 0.1 dB above the original carrier.



**In accordance with the DVB specification, Carrier ID is only available when the Transmit symbol rate is greater than or equal to 128 ksps.**



The CID message is composed of the following information:

- **ODM-840 MAC Address**
- **Contact Telephone number**
- **Latitude and Longitude**
- **Custom message**

---

## E.2 ODM-840 Carrier ID Operation

Carrier ID operation requires that you first enable Carrier ID feature operation, and then create a MetaCarrier Custom Message. All other parameters (center frequency, symbol rate, and the ODM-840's MAC address) are set automatically.

The ODM-840 provides several means for configuring Carrier ID operation via Remote Product Control with a user-supplied PC:

- ODM-840 HTTP (Web Server) Interface using a compatible Web browser.
- Ethernet-based Simple Network Management Protocol (SNMP) using a Network Management System (NMS) and Management Information Base (MIB) File Browser.
- Serial-based Remote Control Interface using a terminal emulation program or Windows Command-line.



**COMTECH EF DATA RECOMMENDS USE OF THE SERIAL-BASED REMOTE CONTROL INTERFACE AND THE ETHERNET-BASED SNMP INTERFACE ONLY FOR ADVANCED USERS. COMTECH EF DATA STRONGLY ENCOURAGES USE OF THE ODM-840 HTTP INTERFACE FOR MONITOR AND CONTROL (M&C) OF THE ODM-840.**

**THE SERIAL AND HTTP INTERFACE FIGURES AS FEATURED THROUGHOUT THIS APPENDIX ARE INTENDED FOR USER REFERENCE ONLY AND ARE SUBJECT TO CHANGE. THE FIRMWARE INFORMATION (I.E., REVISION LETTERS, VERSION NUMBERS, ETC.) AS DISPLAYED MAY DIFFER FROM YOUR SETUP.**

### E.2.1 CID Operation – ODM-840 HTTP Interface



**Chapter 6. ETHERNET-BASED REMOTE PRODUCT MANAGEMENT**



**YOU MAY PROCEED WITH ETHERNET-BASED REMOTE PRODUCT MANAGEMENT (HTTP OR SNMP), ASSUMING THAT:**

- **YOU ARE OPERATING THE ODM-840 WITH THE LATEST VERSION FIRMWARE FILES.**
- **YOU HAVE CONNECTED THE ODM-840 TO A USER-SUPPLIED, WINDOWS-BASED PC AS FOLLOWS:**

- THE PC SERIAL PORT IS CONNECTED TO THE ODM-840 ‘CONSOLE/ REDUNDANCY’ PORT WITH A USER-SUPPLIED 19-PIN-TO-9-PIN ADAPTER SERIAL CABLE.
- THE PC ETHERNET PORT IS CONNECTED TO THE ODM-840 ‘ETHERNET T/M’ ETHERNET PORT WITH A USER-SUPPLIED HUB, SWITCH, OR DIRECT WEATHERPROOF ETHERNET CABLE CONNECTION.
- THE PC IS RUNNING A TERMINAL EMULATION PROGRAM (FOR OPERATION OF THE ODM-840 SERIAL INTERFACE) AND A COMPATIBLE WEB BROWSER (FOR OPERATION OF THE HTTP INTERFACE).
- YOU HAVE NOTED THE ODM-840 TRAFFIC/MANAGEMENT IP ADDRESS USING THE ODM-840 SERIAL INTERFACE.

Figure E-1 shows the ODM-840 HTTP Interface “splash” page, and the menu tree diagram for accessing Carrier ID operation. Page functionality that is not specific to ODM-840 Carrier ID operation appears dimmed.

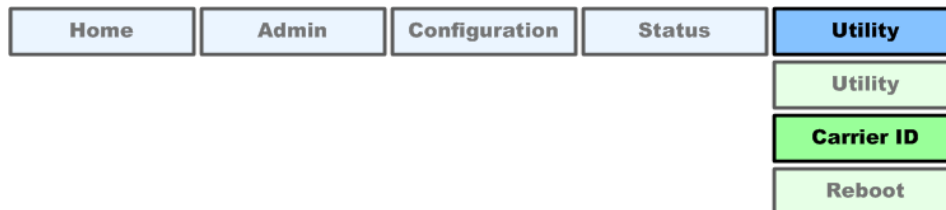
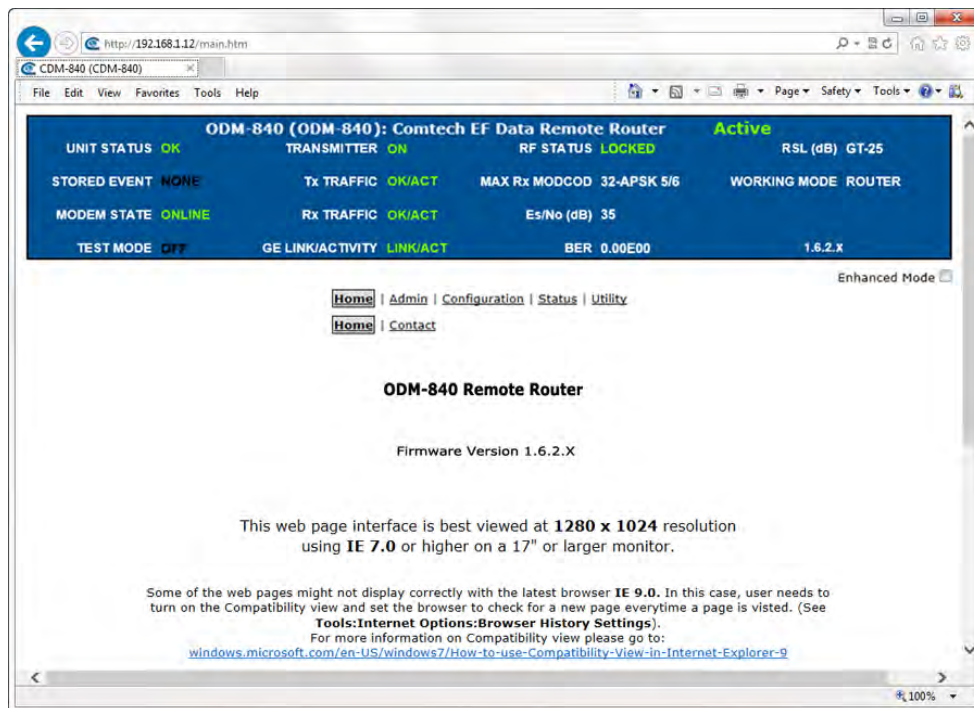
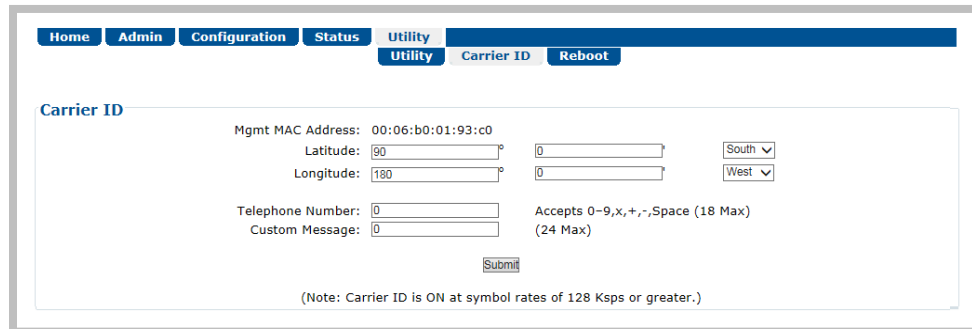

Figure E-1. ODM-840 HTTP Interface and Menu Tree – Carrier ID Operation (FW Ver. 1.6.2.X)

To open the Carrier ID page (**Figure E-2**), click the **Utility** navigation tab, and then select the **CARRIER ID** page tab.



The screenshot shows the Carrier ID configuration page. At the top, there is a navigation bar with tabs: Home, Admin, Configuration, Status, Utility, Carrier ID, and Reboot. The Utility tab is selected. Below the navigation bar, the Carrier ID page is displayed. It contains the following fields and options:

- Mgmt MAC Address: 00:06:b0:01:93:c0
- Latitude: 90° (input field) [0] (input field) [South] (dropdown menu)
- Longitude: 180° (input field) [0] (input field) [West] (dropdown menu)
- Telephone Number: [0] (input field) Accepts 0-9,x,+,-,Space (18 Max)
- Custom Message: [0] (input field) (24 Max)
- [Submit] button
- (Note: Carrier ID is ON at symbol rates of 128 Kbps or greater.)

**Figure E-2. Utility | Carrier ID Page**

## Carrier ID

- **Mgmt MAC Address** – This is the *read-only* **MAC Address** for the ODM-840's M&C card.
- **Latitude** – Set the modem's physical location in **Latitude** in the form **DDMM.mmC**, where:
  - **DD** = degrees (00 to 90);
  - **MM.mm** = whole (00 to 60) and fractional (0 to 99 – tenths or hundredths) minutes;
  - **C** = Use the drop-down list to set the compass cardinal point as **North** or **South**.
- **Longitude** – Set the modem's physical location in **Longitude** in the form **DDDMM.mmC**, where:
  - **DDD** = degrees (000 through 180);
  - **MM.mm** = whole (00 to 60) and fractional (0 to 99 – tenths or hundredths) minutes;
  - **C** = Use the drop-down list to set the compass cardinal point as **East** or **West**.
- Enter a **Telephone Number** to provide a valid emergency contact number to call to resolve operational issues – e.g., in case the modulator's Tx output is causing interference on the satellite. Providing this phone number allows a satellite operator to quickly call the person(s) responsible for correcting any issues.
- Create a **Custom Message** to provide additional information that may be useful in resolving operational issues, e.g., to quickly resolve interference.

Click [**Submit**] to save.

## E.2.2 CID Operation – Serial Remote Control



### Chapter 7. SERIAL-BASED REMOTE PRODUCT MANAGEMENT

The ODM-840's serial remote product management interface is an electrical interface that is either an EIA-485 multi-drop bus (for the control of multiple devices) or an EIA-232 connection (for the control of a single device). The interface uses ASCII characters in asynchronous serial form to transmit data between the Controller (e.g., a User PC) and Target (e.g., the modem and ODU). This data consists of control and status information, transmitted in packets of variable length in accordance with the structure and protocol explained in detail in Chapter 7.

The Controller is in charge of the process of monitor and control, and is the only device that is permitted to initiate, at will, the transmission of data. Targets are only permitted to transmit when they have been specifically instructed to do so by the Controller.

The exchange of information is transmitted, Controller-to-Target and Target-to-Controller, in 'packets'. Each packet contains a finite number of bytes consisting of printable ASCII characters, excluding ASCII code 127 (DELETE).

In this context, the Carriage Return and Line Feed characters are considered printable. With one exception, all messages from Controller-to-Target require a response – this will be either to return data that has been requested by the Controller, or to acknowledge reception of an instruction to change the configuration of the Target.

Controller-to-Target (Issued Command or Query)						
Start of Packet	Target Address	Address Delimiter	Instruction Code	Code Qualifier	Optional Arguments	End of Packet
< ASCII Code 60  (1 character)	0000 (default)  (4 characters)	/ ASCII Code 47  (1 character)	  (3 characters)	= or ? ASCII Codes 61 or 63  (1 character)	  (n characters)	Carriage Return ASCII Code 13  (1 character)

Packet "issued command" example: <0000/MSG=Comtech EF Data[cr]

Packet "issued query" example: <0000/MSG?[cr]

Target-to-Controller (Response to Command or Query)						
Start of Packet	Target Address	Address Delimiter	Instruction Code	Code Qualifier	Optional Arguments	End of Packet
> ASCII Code 62  (1 character)	0000 (default)  (4 characters)	/ ASCII Code 47  (1 character)	  (3 characters)	=, ?, !, *, #, ~ (ASCII Codes 61, 63, 33, 42, 35, or 126)  (1 character)	  (n characters)	Carriage Return ASCII Code 13  (1 character)

Packet example – response received for issued query: >0000/MSG=Comtech EF Data[cr][lf]

The operands available for Carrier ID configuration and operation through ODM-840 Serial-based Remote Product Management are identified in the following table – details on using these CID-specific remote commands and queries are explicitly defined in **Chapter 7**.

<b>Operand</b>	<b>Description</b>
LAT	Sets or returns device Longitude.
LNG	Sets or returns device Latitude.
MSG	Sets or returns the assigned Custom Message.
MUT	Sets or returns the mute mode (operational state).
PHN	Sets or returns the assigned Telephone Number.



# Appendix F. ECM (ENTRY CHANNEL MODE)



**UNLESS OTHERWISE NOTED – This appendix collectively refers to the ODM-840 Remote Router, ODM-840 Remote Router, ODMR-840 Reduced Form Factor Remote Router, and the ODMR-840B Remote Router Board Set as the CDM-840 or the ODM-840.**

---

## F.1 Functional Overview

### F.1.1 ECM Terminology

Abbreviation	Term	Comments
<b>ASR</b>	Application Switch Request	ASR is a private protocol used by the CDM-840 to request bandwidth from the VMS.
<b>BUC</b>	Block Up Converter	The BUC is used in the Tx (uplink) of satellite signals to convert a band of frequencies from a lower frequency to a higher frequency.
<b>CDRP</b>	Comtech Dynamic Routing Protocol	CDRP is used to simplify the deployment of Comtech EF Data's Advanced VSAT solution in an IP-routed network.
<b>dSCPC</b>	Dynamic Single Channel Per Carrier	dSCPC is a Comtech EF Data FAST Feature used to enable dynamic allocation and sharing of bandwidth among users.
<b>HCC</b>	Hub Channel Controller	The HCC is a dedicated CDD-880 that generates the TAP and is responsible for all request transactions from each CDM-840 while in Entry Channel Mode.
<b>LNB</b>	Low-Noise Block Down Converter	The LNB is the receiving device on a parabolic satellite dish used for the Rx (downlink) of satellite signals
<b>RID</b>	Remote Identification	The RID is a message, presented to the Hub Channel Controller upon each transmission into the Aloha channel, which contains the IP Address and control flag.

Abbreviation	Term	Comments
SAS	Set of Aloha Slots	SAS is used as random access for initial request messaging from the CDM-840s.
SRS	Set of Registration Slots	SRS is used for time sensitive management message transactions.
SUM	Status Update Message	SUM is used for updating VMS device control parameters, such as Tx Frequency, Data Rate, Current MODCOD, Eb/No, Es/No, ACM information, etc.
TAP	Transmission Announcement Protocol	The TAP is the time and frequency reference message sent on intervals to synchronize any listening CDM-840s into the Entry Channel.
VMS	Vipersat Management System	A VMS is a configuration, management, and control tool that is used to configure the Advanced VSAT Network and respond to network anomalies.

### F.1.2 ECM Overview



- Comtech EF Data CDD-880 Multi Receiver Router Installation and Operation Manual (CEFD P/N MN-CDD880)
- Comtech EF Data CDM-840 Remote Router Installation and Operation Manual (CEFD P/N MN-CDM840)

Figure F-1 illustrates the processing diagram for Entry Channel Mode (ECM) messaging. ECM is a feature based on slotted Aloha with random retransmission backoff. ECM supports multiple carriers through frequency assignments, which provide simplified deployment and scalability.

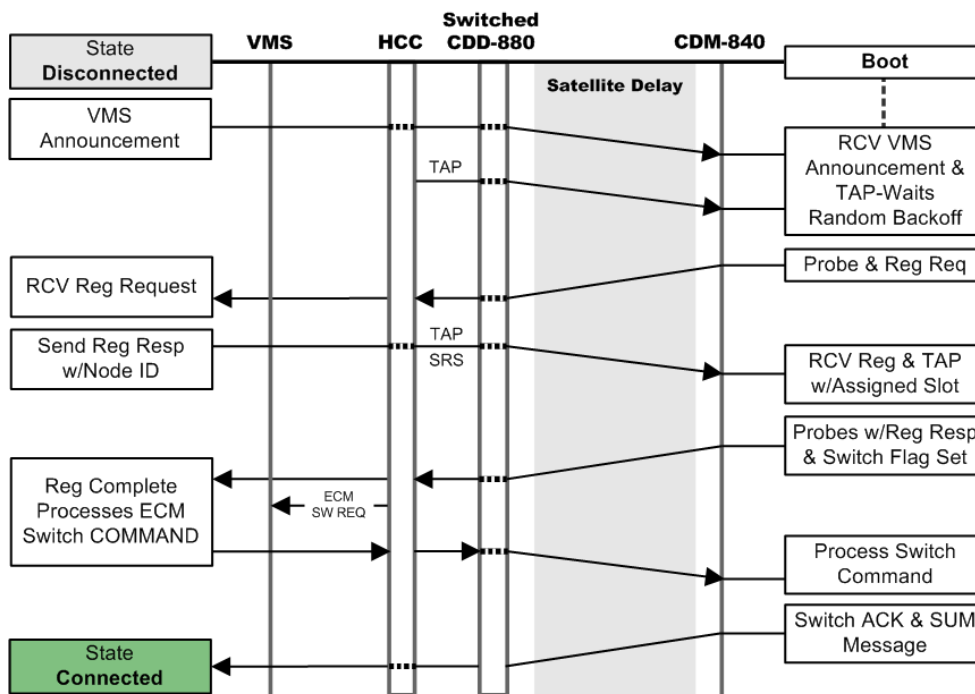

Figure F-1. ECM – Message Processing Diagram



In a typical Comtech EF Data Advanced VSAT System network, the CDD-880 Multi Receiver Router serves as the HCC – Hub Channel Controller – a dedicated hub demodulator selected (mode set) as an ECM controller; Comtech EF Data’s CDM-840 or ODM/R-840/B Remote Router support ECM as an installed component of a typical remote site cluster.

While an ODM-840 is in Entry Channel Mode, it allows the passing of management traffic only – it will not transmit user data traffic. An ECM-enabled ODM-840 may remain in the entry channel for an extended period if “online” communications are not required, or if dSCPC (Dynamic Single Carrier Per Channel) resources are unavailable. While idle or waiting in the entry channel, the ODM-840 sends periodic health status messages while it continues to service VMS recovery logic timers.

Note that a “channel” refers to a fixed carrier slot on the satellite that allows the ODM-840 Remote Router random access (in time) to a readied HCC (CDD-880) for transacting each acquired transmission. Each CDD-880 supports only one Entry Channel; this channel is always assigned to Demod #1.

The HCC uses a TAP (Transmission Announcement Protocol) message to broadcast a key subset of transmit parameters that match its receive configuration, but assumes all other site specific parameters were preconfigured at the time of antenna commissioning. In addition, the TAP provides timing information in the form of slot parameters that define the required acquisition time of the receiver and the amount of time allowed for data transmission. The TAP also contains a list of ODM-840s that successfully transmitted during the previous cycle. The list of ODM-840s from which the HCC expected – but did not receive – a response is also provided; these ODM-840s are assigned a slot for the next cycle.

Each associated ODM-840 achieves loose time synchronization via the broadcast TAP message transmitted at periodic intervals. Since the TAP transmits via the satellite, all ODM-840s receive it at effectively the same time, with delay differences (due to geographic variation of each remote site cluster) compensated with a specified guard time. Upon receipt of the TAP message, the ODM-840 resets its ECM time reference and uses the slot information to determine/select the next transmit opportunity:

- If the ODM-840 has transmitted in the previous cycle, and does not indicate it is finished, it receives an assigned slot as indicated by its IP Address.
- If the ODM-840 does not have an assigned slot, it randomly picks one from the available contention slots.
- If no contention slots are available, the ODM-840 waits for the next cycle.

This process allows each ODM-840 to transmit at a discrete time to minimize the chance of collision. To reduce slot contention further, a random backoff (next slot) algorithm is deployed if the transmission was not received. Each ODM-840 attempts to enter the network by gauging its transmissions from this timing reference, randomly picking one of the Set Aloha Slots (SAS) presented by the TAP message. The transmit “on” time is of a fixed duration, allowing sufficient time for the receiving CDD-880 to acquire and pass the management signaling messages. The

ODM-840 will continue to attempt access on cadence intervals using random backoffs, selecting a different SAS until receiving positive acknowledgement from the HCC.

Upon valid reception, the HCC processes the Remote Identification (RID) packet containing the ODM-840 IP Address, TAP (Group) ID, and ECM state flags. Each ODM-840 sign-on IP Address is added to a list of ODM-840(s) that are queued and await assignment.

Depending on the ECM state flag, the ODM-840 either remains idle in the channel or is assigned one of the next available time-sensitive slots. Each slot, labeled as a Set of Registration Slot (SRS), is also assigned through the TAP and allows the ODM-840 to complete any necessary transaction without further contention.

The ODM-840 then holds an SRS until it receives its assignment into dSCPC or determines that all necessary transactions are complete; at this time, it releases the slot by signaling the HCC through the RID message.

Upon release of the slot, the HCC re-assigns it to the group of contention slots. This cycle repeats until all ODM-840s either have been switched to dSCPC channels or require no further interaction.

Once the ODM-840 indicates that registration with VMS is complete (via one of the flags in the RID message), on behalf of the ODM-840 the HCC requests dSCPC assignment by placing the ODM-840 IP Address into the “switch pending” list and sending an ECM type switch request message to the VMS. The VMS, upon receipt, either *grants* the request and signals the HCC to remove the ODM-840 from its list, or *ignores* the request and leaves the ODM-840 in the “switch pending” list. The HCC repeats this request at 12-second intervals up to five times before it removes the ODM-840 from the “switch pending” list. While the ODM-840 is in this “switch pending” ECM state, it continues to send SUM health status update messages to the VMS on timed intervals. Since all ECM transmissions from the ODM-840 contain a RID, this causes the ODM-840 to be placed back in the “switch pending” list. This cycle continues until the ODM-840 switches, or is set to ECM Wait state, or goes offline.

The VMS is the last step in the entry process that provides network registration, and grants or ignores dSCPC resources. If resources are limited because of bandwidth, hardware, or unavailability, the ODM-840s will remain in the entry channel pending assignment.



**The VMS plays no role in ECM timing or control.**

### F.1.3 ODM-840 ECM Message Processing

Figure F-2 illustrates the internal logic diagram of the remote processing registration message.

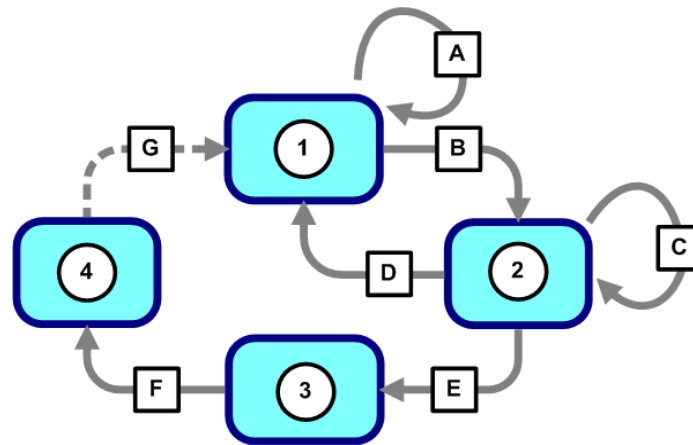

Processing Segment	Description	Remarks	Action	Remarks
1	ALOHA	"Not Registered" or "Reverted"	A	Random registration attempts with backoff until in TAP
2	REGISTRATION		B	In TAP
3	SWITCH PENDING		C	Complete the registration protocol
4	SWITCHED		D	Not in TAP
			E	Registration complete – no more Slots needed
			F	Received "Switch Command" message from VMS
			G	Received "Revert" message from VMS

**Figure F-2. ECM Message Processing – ODM-840 Remote Router**

- The ODM-840s are configured to receive the outbound carrier and are given a TAP (Group) identifier number (default 1) that sets the internal filtering if multiple TAPs are used.
- Upon receipt of the TAP message, the ODM-840 sets modem transmission parameters (if required), initializes timing, and picks at random an SAS to start entry by sending a *probe* (slot transmission).
- The ODM-840, based on its current ECM state, either requests an *assigned slot* or waits to be *switched*:
  - An *assigned slot request* indicates to the HCC if the ODM-840 has more data (e.g. registration protocol) to send.
  - A *switch request* indicates that the ODM-840 is requesting dSCPC bandwidth. These two flags are independent.

### F.1.4 CDD-880 ECM Message Processing

Figure F-3 illustrates the internal logic diagram of the HCC processing of remote messages.

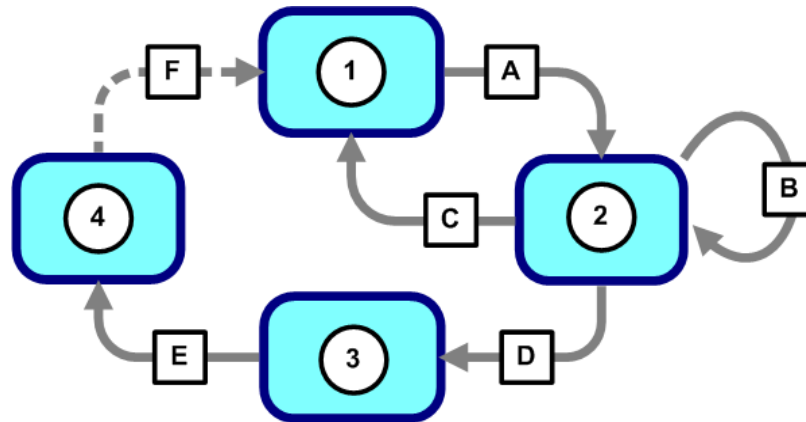

Processing Segment	Description	Remarks
1	ALOHA	
2	TAP	In "Assigned Slot" list
3	SWITCH PENDING	In "Switch Pending" list – Switch Request sent to VMS up to 5X in 12-second intervals until response
4	SWITCHED	

Action	Remarks
A	RID Detected – add to Detection List of TAP
B	RID Detected – add to Detection List of TAP
C	Missed 'N' Consecutive Cycle
D	Registration complete – no more slots needed
E	"Disable" message received from VMS
F	ODM-840 received "Revert" message from VMS

Figure F-3. ECM Message Processing – CDD-880 Multi Receiver Router

---

## F.2 ECM Operational Scenarios

### F.2.1 Scenario 1 – VMS Initial Registration Process

For proper registration with the VMS, initialization (power-up and bootup) of the ECM-enabled ODM-840 is required.

Upon initialization, the ODM-840:

1. Receives a VMS Announcement, sets up an active VMS IP Address, and initializes ECM TAP processing;
2. Transmits a registration request using a selected SAS, and sets a “Needs Slot” flag in the RID message;
3. Receives the HCC response, through the TAP, assigning an SRS;
4. Continues to transmit the registration request message in SRS;
5. Receives registration from the VMS (Standard Processing);
6. Transmits a registration acknowledgement to the VMS in SRS – it signals the HCC by clearing “Needs Slot” and sets the “Registered with VMS” and “Need to be Switched” flags in the RID message.
7. Receives the HCC response, through the TAP, as an acknowledgement – the HCC then clears the SRS allocation and sends ECM switch requests to the VMS on behalf of the ODM-840 (Standard Processing);
8. Waits for VMS dSCPC assignment (Standard Processing).

### F.2.2 Scenario 2 – Reverted or Auto-Recovered Messages

“Revert” or “Auto Recover” of an already registered ODM-840 is required when:

- The ODM-840 was forced into or dropped back to ECM mode;
- The ODM-840 transmits into an SAS setting due to a “Need to be Switched” flag in the RID message;
- The HCC sends ECM switch requests to the VMS on behalf of the ODM-840 (Standard Processing).

---

### F.2.2.1 ECM Revert Cycle Timing

When an ODM-840 reverts from dSCPC to ECM, there is typically no wait because the ODM-840 is always monitoring TAP cycles to synchronize. It then randomly selects a slot in the next cycle and transmits. If the probe is not detected at the corresponding CDD-880 (as indicated by the next TAP to the ODM-840), it backs off by doubling the cycle and selecting another random slot. If the revert happened near the end of the cycle the ODM-840 wait for next TAP.

The ECM TAP cycle duration is designed to be approximately 3 seconds in order to correlate with a recommended VMS message timeout of 5 seconds. This allows the ODM-840 to respond to most VMS requests before the VMS times out and goes into “retry” mode. This optimizes for normal conditions, but may result in slight delays in the event of a catastrophic recovery when a large number of ODM-840s are all trying to transition from ECM to dSCPC mode.

The **Slots in Frame** setting is determined automatically by the HCC, based on the target cycle of 3 seconds and the assigned data rate of the ECM Channel. Essentially, the HCC determines the required acquisition time based on the symbol rate and the data slot time based on the data rate. (Note that only MODCOD 0 (BPSK .488) is supported for ECM so the data rate is approximately half the symbol rate.) These are added to the Guard Band; the result (total time per slot) is divided by 3 seconds, and that result is then rounded up to the next integer number of slots. For example, for a typical Entry Channel at 64 Kbps with a Guard Band of 50 ms, this results in a total of 8 slots per cycle.

---

### F.2.2.2 ECMv2 Backoff Algorithm

The ECMv2 Backoff Algorithm optimizes between quick entry in a quiet network and minimal collisions in an active network. Its key feature is the concept of fixed-length data slots within a repeating frame (or cycle). Each total slot consists of three components:

- Acquisition Preamble
- Data Segment for Management Messages
- Guard Band to resolve timing uncertainty

An integral number of VersaFEC blocks are used for both the preamble and the data segment; the Guard Band will vary due to system timing uncertainties and propagation delay due to the geographic dispersion of the ODM-840s.



**A Guard Band of 50ms is sufficient in most cases to accommodate geographical latency differences and internal timing errors.**

The preamble is pre-determined based on calibration tables for receiver acquisition at the current data rate and MODCOD 0 (BPSK .488) (actual value is based on symbol rate; starting with 14 blocks and increasing by 1 block for every 556 kbps). The data segment is sized to support the largest messages needed to complete the Entry Channel handshake protocol and maintain status and CDRP (fixed at 6 VersaFEC blocks (765 bytes)). The actual size (in milliseconds) of each slot is

therefore a function of the data rate and the number of bits in a VersaFEC block for the ModCod of the ECM channel.

When an ODM-840 is ready to transmit, it waits for receipt of a TAP message that establishes time synchronization between all ODM-840s. The TAP message also describes the configuration of the Entry Channel Control receiver. The ODM-840 uses the information in the TAP to configure its own Tx parameters and then checks for available Aloha Slots. If slots are available, it randomly selects one of the available slots.



**During heavy use, it is possible that all available slots will be dedicated to ODM-840s that have already initiated the entry handshake although this situation should never last more than two cycles unless there are collisions or degraded link state.**

The slot number, multiplied by the total slot length (in milliseconds) provides the start time for transmission, which is always relative to the receipt of the last TAP message.



**The total slot length is the sum of the Guard Band, Preamble, and Data Segment that are all provided in the TAP message.**

After transmitting its request, the ODM-840 waits for the next TAP message that indicates if that transmission was detected by the Entry Channel Controller. If the transmission is detected, the ODM-840 receives an assigned slot in the current frame and continues to receive assigned slots until it indicates it has completed its entry protocol. If the next TAP does *not* include an assigned slot, the ODM-840 assumes a collision occurred and begins the backoff algorithm.

The backoff is based on contention levels of  $2^n$  (where  $n = 0$  to  $4$ ; i.e.  $2^0=1$ ,  $2^1=2$ ,  $2^2=4$ ,  $2^3=8$ , and  $2^4=16$ ). The Contention Level always starts at 0, which means the ODM-840 transmits in the next frame when it receives a TAP message. If the transmission is not detected, the ODM-840 goes to Contention Level 1 and picks a random slot in one of the next two frames. If it is *still* not detected, Contention Level goes to 3 and the ODM-840 randomly picks a slot in one of the next four frames.

If the ODM-840 is not detected by Contention Level 4 (16 frames), it then resets to Contention Level 0 and tries again – the ODM-840 uses one random number to select a frame at the current contention level and another random number to select a slot within the frame.



**Since the ODM-840s are not aware of each other, their Contention Levels are independent and determined only by when they were initially ready to transmit.**

---

## F.3 ECM Operation



For detailed information, see:

- **F.1.1 ECM Terminology and F.1.2 ECM Overview in this appendix, for descriptions of the terms used in this section.**
- **Chapter 6. ETHERNET-BASED REMOTE PRODUCT MANAGEMENT and Chapter 7. SERIAL-BASED REMOTE PRODUCT MANAGEMENT in this manual.**
- **Chapter 6. ETHERNET-BASED REMOTE PRODUCT MANAGEMENT and Chapter 7. SERIAL-BASED REMOTE PRODUCT MANAGEMENT in the CDD-880 Multi Receiver Router Installation and Operation Manual (CEFD P/N MN-CDD880).**
- **Appendix G. ENTRY CHANNEL MODE SWITCHING in the adjunct CEFD publication VMS v3.x.x VIPERSAT Management System User Guide (CEFD P/N MN/22156).**

The ODM-840 and CDD-880 provide several means for configuring ECM operation via Remote Product Control with a user-supplied PC:

- Serial-based Remote Control Interface using a terminal emulation program or Windows Command-line. See **Sect. 0**.
- ODM-840 and CDD-880 HTTP (Web Server) Interfaces using a compatible Web browser. See **Sect.F.3.2**.
- Ethernet-based Simple Network Management Protocol (SNMP) using a Network Management System (NMS) and Management Information Base (MIB) File Browser.



**COMTECH EF DATA RECOMMENDS USE OF THE ETHERNET-BASED SNMP INTERFACE AND SERIAL-BASED REMOTE CONTROL INTERFACE ONLY FOR ADVANCED USERS. COMTECH EF DATA STRONGLY ENCOURAGES USE OF THE ODM-840 AND CDD-880 HTTP INTERFACES FOR MONITOR AND CONTROL (M&C) OF THE ODM-840 OR CDD-880.**

**THE SERIAL AND HTTP INTERFACE FIGURES FEATURED THROUGHOUT THIS APPENDIX ARE INTENDED FOR USER REFERENCE ONLY AND ARE SUBJECT TO CHANGE. THE FIRMWARE INFORMATION (I.E., REVISION LETTERS, VERSION NUMBERS, ETC.) AS DISPLAYED MAY DIFFER FROM YOUR SETUP.**



### F.3.1 ECM Operation – ODM-840 Serial Remote Control



#### Chapter 7. SERIAL-BASED REMOTE PRODUCT MANAGEMENT

The ODM-840’s serial remote product management interface is an electrical interface that is either an EIA-485 multi-drop bus (for the control of multiple devices) or an EIA-232 connection (for the control of a single device). The interface uses ASCII characters in asynchronous serial form to transmit data between the Controller (e.g., a User PC) and Target (e.g., the modem and ODU). This data consists of control and status information, transmitted in packets of variable length in accordance with the structure and protocol explained in detail in Chapter 7.

The Controller is in charge of the process of monitor and control, and is the only device that is permitted to initiate, at will, the transmission of data. Targets are only permitted to transmit when they have been specifically instructed to do so by the Controller.

The exchange of information is transmitted, Controller-to-Target and Target-to-Controller, in ‘**packets**’. Each packet contains a finite number of bytes consisting of printable ASCII characters, excluding ASCII code 127 (DELETE).

In this context, the Carriage Return and Line Feed characters are considered printable. With one exception, all messages from Controller-to-Target require a response – this will be either to return data that has been requested by the Controller, or to acknowledge reception of an instruction to change the configuration of the Target.

Controller-to-Target (Issued Command or Query)						
Start of Packet	Target Address	Address Delimiter	Instruction Code	Code Qualifier	Optional Arguments	End of Packet
< ASCII Code 60  (1 character)	0000 (default)  (4 characters)	/ ASCII Code 47  (1 character)	  (3 characters)	= or ? ASCII Codes 61 or 63  (1 character)	  (n characters)	Carriage Return ASCII Code 13  (1 character)

**Packet “issued command” example:** <0000/MSG=Comtech EF Data[cr]

**Packet “issued query” example:** <0000/MSG?[cr]

Target-to-Controller (Response to Command or Query)						
Start of Packet	Target Address	Address Delimiter	Instruction Code	Code Qualifier	Optional Arguments	End of Packet
> ASCII Code 62  (1 character)	0000 (default)  (4 characters)	/ ASCII Code 47  (1 character)	  (3 characters)	=, ?, !, *, #, ~ (ASCII Codes 61, 63, 33, 42, 35, or 126)  (1 character)	  (n characters)	Carriage Return ASCII Code 13  (1 character)

**Packet example – response received for issued query:** >0000/MSG=Comtech EF Data[cr][lf]

The operands available for ECM configuration and operation through ODM-840 Serial-based Remote Product Management are identified in the following table – details on using these ECM-specific remote commands and queries are explicitly defined in **Chapter 7**.

Operand	Description
EMD	Enable or disable ECM Mode operation
EBP	Configure or query the Tx base power
EMI	Configure or query the VMS Multicast IP Address
EGI	Configure or query the ECM Group ID
EPH	Configure or query the ECM Mode power hunt function
ERF	Configure or query the Rx LO frequency
ETF	Configure or query the Tx LO frequency

### F.3.2 ECM Operation – HTTP Interfaces



**YOU MAY PROCEED WITH ETHERNET-BASED REMOTE PRODUCT MANAGEMENT (SNMP OR WEB SERVER), ASSUMING THAT:**

- **YOU ARE OPERATING THE ODM-840 WITH THE LATEST VERSION FIRMWARE FILES.**
- **YOU HAVE CONNECTED THE ODM-840 TO A USER-SUPPLIED, WINDOWS-BASED PC AS FOLLOWS:**
  - **THE PC SERIAL PORT IS CONNECTED TO THE ODM-840 ‘CONSOLE/ REDUNDANCY’ PORT WITH A USER-SUPPLIED 19-PIN-TO-9-PIN ADAPTER SERIAL CABLE.**
  - **THE PC ETHERNET PORT IS CONNECTED TO THE ODM-840 ‘ETHERNET T/M’ ETHERNET PORT WITH A USER-SUPPLIED HUB, SWITCH, OR DIRECT WEATHERPROOF ETHERNET CABLE CONNECTION.**
  - **THE USER PC IS RUNNING A TERMINAL EMULATION PROGRAM (FOR OPERATION OF THE ODM-840 SERIAL INTERFACE) AND A COMPATIBLE WEB BROWSER (FOR OPERATION OF THE ODM-840 HTTP (WEB SERVER) INTERFACE).**
- **YOU HAVE NOTED THE ODM-840 TRAFFIC/MANAGEMENT IP ADDRESS USING THE ODM-840 SERIAL INTERFACE.**
- **YOU HAVE INSTALLED AND ENABLED THE OPTIONAL VIPERSAT MANAGEMENT SYSTEM (VMS).**

**Figure F-4** shows the ODM-840 HTTP Interface “splash” page, and the menu tree diagram for accessing ECM operation. Page functionality not specific to ECM operation appears dimmed in this diagram.

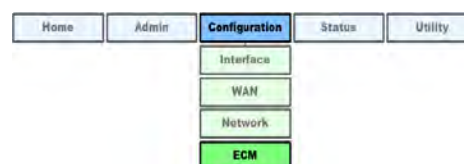

(TOP) ODM-840 HTTP Interface  
(BOTTOM) CDD-880 HTTP Interface

**Figure F-4. HTTP Interfaces – Splash Pages and ECM Operation Menu Trees (FW Ver. 1.6.2.X)**

Note that ECM uses Demod 1 as the ALOHA channel. Proper deployment of ECM in the Advanced VSAT Network requires complimentary configuration of both the hub site CDD-880(s) and the remote site ODM-840(s) using each product’s HTTP Interface ‘**Configuration | ECM**’ page (Figure F-5):

- Use the CDD-880 HTTP Interface to configure a basic set of parameters that define the channel group. The settings consist of Enabling, TAP Multicast IP Address, TAP (group) ID, and Guard Band.
- Use the ODM-840 HTTP Interface to configure one of three modes (states) of ECM operation: **Online**, **Wait** or **Offline**.

You must also specify an LNB LO Frequency and Satellite Frequency Conversion to accommodate mismatches between the hub site LNB and remote site BUCs. Channel parameters are determined from the CDD-880 configuration settings. If spectral inversions apply, all hub receiving CDD-880s that are part of that downlink chain must be set to match.

### F.3.2.1 ODM-840 HTTP Operation – Remote Router Terminals

Click the **Configuration** tab, and then the **ECM** tab to open the page (Figure F-5).

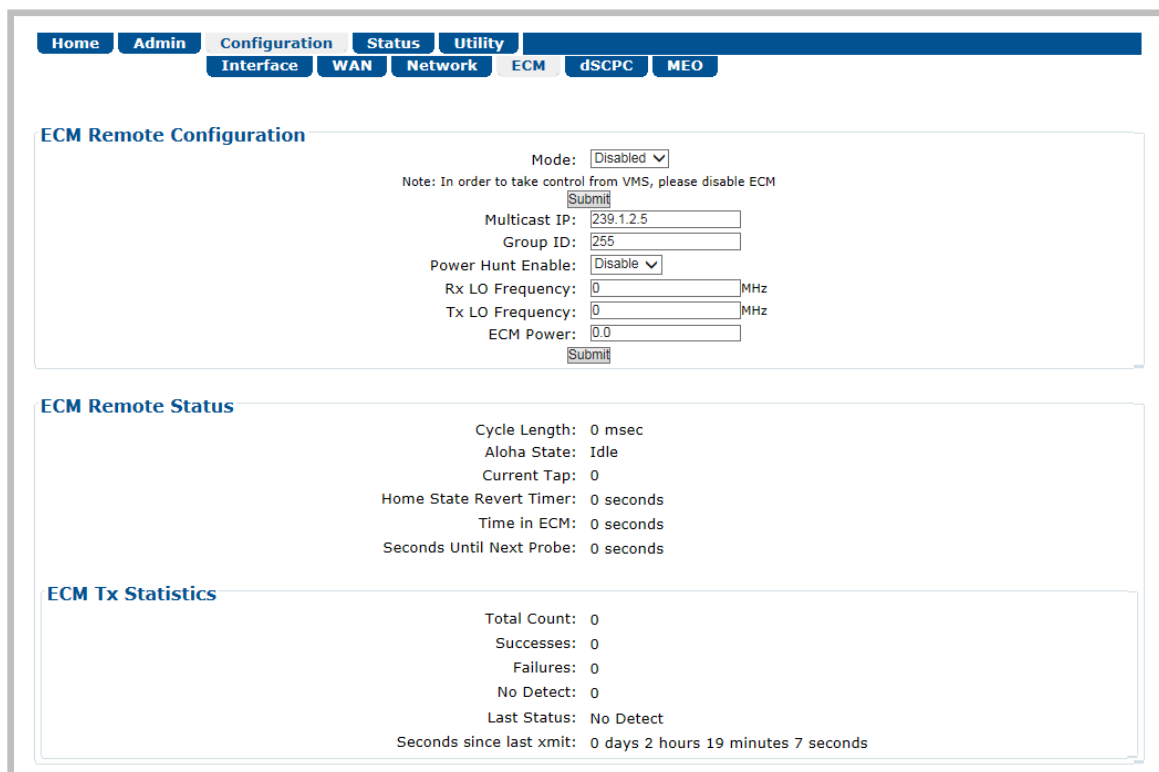

**ECM Remote Configuration**

Mode:

Note: In order to take control from VMS, please disable ECM

Multicast IP:

Group ID:

Power Hunt Enable:

Rx LO Frequency:  MHz

Tx LO Frequency:  MHz

ECM Power:

**ECM Remote Status**

Cycle Length: 0 msec

Aloha State: Idle

Current Tap: 0

Home State Revert Timer: 0 seconds

Time in ECM: 0 seconds

Seconds Until Next Probe: 0 seconds

**ECM Tx Statistics**

Total Count: 0

Successes: 0

Failures: 0

No Detect: 0

Last Status: No Detect

Seconds since last xmit: 0 days 2 hours 19 minutes 7 seconds

Figure F-5. ODM-840 HTTP Interface – Configuration | ECM Page

#### ECM Remote Configuration

- **Mode:** – Use the drop-down list to select operation as **Disabled**, **Offline**, **Wait**, or **Online**. Each ECM state establishes a different role for the ODM-840 in the overall Advanced VSAT Network operations:
  - **Online** – This is the most common ECM state, whereby the ODM-840 powers up, requests network registration, and switches to dSCPC at the minimum site policy data rate setting.
  - **Wait** – Allowing all ODM-840s in the network to automatically request dSCPC bandwidth can result in *oversubscription*, where some percentage of ODM-840s wait their turn for SCPC pooled resources. To avoid oversubscription, the ECM Wait State provides the network operator with the ability to selectively control the ODM-840s through manual, scheduled, or externally switched request commands.

With the ODM-840s set to **Wait**, they continue to send their health status update messages to the VMS and to the CTOG-250 Comtech Traffic Optimization Gateway (with integrated CDM-800 Gateway Router). The VMS messages update connected link status;

when dynamic routing mode is enabled, the ACM, CDRP, and data traffic statistics messages sent to the CTOG-250 maintain the forward path ACM and routing tables.

- **Offline** – In this ECM state, the ODM-840 does not transmit and remains idle until a new ECM state is selected either locally or from the VMS. Examples for use of this particular ECM state are COTM (communications on the move) or military maneuvers providing radio silence conditions.

Click **[Submit]** to save.

- **Multicast IP:** – Enter the IP address for the Multicast of the Transmission Announcement Protocol (TAP) message that is sent out by the CDD-880 to all of the associated ODM-840s in that group.
- **Group ID:** (0 to 255) – Enter the Group ID number for the CDD-880 to which this unit belongs.
- **Power Hunt Enable:** – Use the drop-down list to select this function as **Disable** or **Enable**. When enabled, the transmission power control feature for the unit modulator is activated while in ECM. This function provides compensation during periods of impaired transmission or for instances when the initial (baseline) power value is insufficient, and assists in maintaining return link integrity.

The Power Hunt feature starts with nominal power under ideal conditions, and will probe/listen for a response. If a response is not received, it could be the result of either insufficient power or a collision with another remote. A backoff sequence is attempted and, if there is no response, then the probing sequence is repeated with an increase of Tx output power, in 3dB increments up to a total increase of 9dB.



#### Appendix L. DPC (VMS DYNAMIC POWER CONTROL)

- **Rx LO Frequency:** – Assign a value, in MHz, to the Rx LO (Low Oscillator) Frequency.
- **Tx LO Frequency:** – Assign a value, in MHz, to the Tx LO (Low Oscillator) Frequency.
- **ECM Power:** (-40.0 to 0.0) – Enter the power level, in dBm, for transmission of the Aloha ECM signal. This level was determined for this unit when its terminal was commissioned, and must be calibrated with the satellite provider.

Click **[Submit]** to save.

### ECM Remote Status

This section provides the following *read-only* information:

- **Cycle Length:** – The Cycle Length is the total length of time, in milliseconds, between the start of a transmission and the completion of the transmission cycle (TAP) transmitted by

the CDD-880 to the ODM-840s in the ECM group. It is the product of the number of slots and the slot length (consisting of the preamble, data slot size, and Guard Band).

- **Aloha State:** – The Aloha State indicates the current state of this unit during the ECM cycle:
  - **Idle** – The unit is not transmitting; either inactive or waiting for switching assignment.
  - **Active** – The unit is actively transmitting (probing) to the Hub for either registration or request for switching to dSCPC.
  - **Switched** – the Remote has successfully switched from ECM to dSCPC.
- **Current Tap:** – Indicates current value of sequential progression of TAP message transmission. Ranges from 0 to 255, then repeats.
- **Current Slot:** – The time slot number that has been assigned to this unit in the transmission cycle for switching from ECM to dSCPC.



**This number is only valid for the current cycle and is intended mostly for diagnostic purposes during troubleshooting.**

- **Home State Revert Timer:** – The time, in seconds, that must pass without receiving communications from the HCC (Hub Channel Controller – i.e., Demod #1 on the CDD-880, the designated ECM controller) TAP message before this unit is reverted from dSCPC mode back to ECM to re-establish communications settings for receiving the TAP. *This parameter is set in the VMS.*
- **Probing Duration:** – Amount of time, in seconds, that this unit has been transmitting to the HCC to request registration and switchover.
- **Seconds Until Next Probe:** – The time period, in seconds, before this unit will again transmit to the HCC.



**If this number is greater than 3 seconds, it means that the modem is in backoff mode.**

## ECM Tx Statistics



**Whenever the modem reverts from dSCPC to ECM, the statistics will clear.**

This section provides the following *read-only* information:

- **Total Count:** – This is the total number of transmissions since the modem entered Entry Channel Mode.
- **Successes:** – This is the number of successful (entire) transmissions received by the hub.
- **Failures:** – This is the number of incomplete transmissions that were detected by the hub.

- **No Detect:** – This is the number of transmissions that were undetected by the hub.
- **Last Status:** – This displays the status of the most recent transmission as **Success**, **Failure**, or **No Detect**.
- **Seconds since last xmit:** – This is the number of seconds since the last transmission, regardless of status.

### F.3.2.2 CDD-880 HTTP Operation – Hub Channel Controller (HCC)

Click the **Configuration** tab, and then the **ECM** tab to open the page (Figure F-6).

The screenshot displays the 'ECM Hub Configuration' page. At the top, there are navigation tabs: Home, Admin, Configuration (selected), Status, and Utility. Under 'Configuration', there are sub-tabs: Interface, WAN, Network, ECM (selected), and MEO. The main content area is titled 'ECM Hub Configuration' and contains several configuration fields:

- Enable:  (with a dropdown arrow)
- 
- Multicast IP:
- Group ID:
- Guard Band:
- Preamble:
- Data Slot Size:
- Slots in Frame:
- Cycle Length:
- LNB LO Frequency:  MHz
- Satellite Frequency Conversion:  MHz
- 

Below the configuration fields is the 'ECM Hub Status' section. It includes a table with the following data:

Index	IP	State	Frames Transmitted	Error Frames
0	0.0.0.0		0	0

Current contention slots available: 0

Figure F-6. CDD-880 HTTP Interface – Configuration | ECM Page

#### ECM Hub Configuration

The acceptable/valid operating ranges for items in this section are provided in parentheses.

- **Enable:** – This feature activates Demod-1 (Rx TRAFFIC 1) on this unit to function as the ECM Controller for a group of ODM-840s. Use the drop-down list to select operation as **Enable** or **Disable**, and then click **[Submit]** to save.
- **Multicast IP:** – Enter the IP address for the Multicast of the TAP message that is sent out by this CDD-880 to all of the associated ODM-840s in that group.
- **Group ID:** (0-255) – Assigning a unique Group ID number to this CDD-880 (i.e., the HCC) and its associated ODM-840s defines the group of equipment that will respond to the output of the controller. Enter the Group ID number for the CDD-880.



**While “0” is an acceptable assignment, the preferred practical range is from 1 to 255.**

- **Guard Band:** (1-1000) – Enter the Amount of Transmit Off time, in milliseconds, between slots to prevent signal overlap.
- **Preamble:** – This *read-only* value identifies the preamble length in VersaFEC frames.
- **Data Slot Size:** – This *read-only* value identifies the minimum number of Versa FEC blocks in a data slot.
- **Slots in Frame:** – This *read-only* value identifies the allowable total number of slots for each frame. When assigned slots are needed, they are taken from this pool.
- **Cycle Length:** – This *read-only* value identifies the total cycle length, in milliseconds, of the TAP message.
- **LNB LO Frequency:** – Assign the LNB LO value, used to send RF frequency values in TAP messages. Resolution = 100Hz.
- **Satellite Frequency Conversion:** – Assign the correct **Satellite Frequency Conversion** value, in MHz, for this hub unit based on the RF equipment used at this site.

Click [**Submit**] to save.

### ECM Hub Status (*read-only*)

- **Current Contention slots available** – “Contention slots” are the number of time slots in the TAP transmission cycle that are available for assignment to requesting (probing) Remotes.

*From left to right:*

Column	Description
Index	This is the automatically assigned internal table index number.
IP	IP address for the identified ODM-840 Remote Router.
State	Current state of this ODM-840 – one of the following will apply: <ul style="list-style-type: none"> <li>• <b>Probing</b> – The unit is requesting service (registration / switching) from the VMS.</li> <li>• <b>Registered</b> – The unit has been registered with the VMS.</li> <li>• <b>Waiting to switch</b> – the Unit is awaiting dSCPC switch command from the VMS.</li> </ul>
Frames Transmitted	Count of frames received from this ODM-840.
Error Frames	Count of frames received with errors from this ODM-840.



### F.3.2.2.1 Tap Message

The TAP message is a standard UDP/IP multicast forward over the outbound channel with a payload containing the following sections:

- Standard Vipersat Header (distinguishes TAP from other Vipersat messages)
- Timestamp field (set by ODM-840 [at WAN interface] when TAP is received)
- Aloha Channel Frequency Plan (Frequency, Data Rate, Modulation, and Coding)
- Slot and Timing Control
- Lists of ODM-840s with Assigned Slots (previous transmission succeeded / failed)
- List of ODM-840s that have completed their handshake in the last cycle

As noted previously, receipt of a TAP causes all listening ODM-840s to synchronize internal transmit timing clock in order to minimize collisions in the Aloha channel.

### F.3.2.2.2 HCC Configuration

The TAP IP Address specifies the multicast address that all ODM-840s in the group use to receive the TAP:

- Timing as exposed to the user is message interval;
- Total slot count that derives the Cycle Length is set in milliseconds;
- All other parameters are calculated based on current rate;
- The Date Slot Size is fixed at 6, and VersaFEC Blocks and Preamble is computed in milliseconds based on the specified data rate;
- Guard Band is determined during terminal commissioning.

### F.3.2.2.3 Hub Operation

After configuration and initialization, the HCC broadcasts the TAP message on cycle intervals waiting for Aloha channel RID messages. Successful reception of the RID places the indicated ODM-840 IP Address along with its ECM state flag (i.e., **Online**, **Wait**, or **Offline**) into the first queued list. The controller checks the flag to determine next operation. If the ECM state is **Online**, an SRS is assigned for next TAP processing.

- The ODM-840 receives the TAP with its IP Address in the SRS list and, based on where its place is in the sequential order, determines the slot assignment. By design convention, assigned slots are at the end of the cycle and whatever remains is used for contention at the

beginning of the cycle. With the assignment, the ODM-840 transmits management data in its assigned slot and awaits acknowledgment and next assignment.

- After the ODM-840 completes its registration protocol, it releases the active flag in the next RID cycle. At this point, the HCC will remove the processing ODM-840's IP Address from the list clearing the SRS allocation. If the ODM-840 is not switched out of ECM mode, it will proceed to send a Status Update Message (SUM) every minute (or as configured by VMS during registration) in order to maintain its active status with VMS. Typically, a SUM should only require one transmission unless there is contention, in which case the ODM-840 will go into back-off mode until the ODM-840 received acknowledgment from the HCC that the SUM was successfully transmitted.

# Appendix G. HEADER AND PAYLOAD COMPRESSION



**UNLESS OTHERWISE NOTED** – This appendix collectively refers to the ODM-840 Remote Router, ODMR-840 Reduced Form Factor Remote Router, and the ODMR-840B Remote Router Board Set as the ODM-840.

---

## G.1 Functional Overview

Header and Payload Compression are standard features provided in Comtech EF Data's Advanced VSAT Series group of products, including the ODM-840 Remote Router.

The ODM-840 implements Payload Compression via the presence of a GZIP ASIC on the ODM-840 main board. This integrated circuit provides the transmit compression and receive decompression capabilities for maximum throughput and efficiency.

With Header Compression, the compression library that is incorporated into the ODM-840 for all IP traffic can reduce 40-byte IP/UDP/RTP headers to as little as one (1) byte, or as little as three (3) bytes for TCP/IP. For Voice-over-IP (VoIP), Header Compression provides bandwidth savings greater than 64%.

For example, using an 8kbps G.729E voice codec requires 24 kbps of IP bandwidth once encapsulated into an IP/UDP/RTP datagram. With Comtech EF Data's Header Compression enabled, the same voice call requires only an approximate 8.5 kbps – a savings of almost 65%. Additionally, bandwidth requirements for typical Web/HTTP traffic can be reduced by 10% or more with TCP/IP Header Compression operation enabled.

With Payload Compression, the required satellite bandwidth can be reduced by as much as 40 to 50% based on Calgary Corpus files. The compression algorithm can be applied to all data, SLE, and DVB-S2 header excluded. Compression statistics are fed back to the Quality of Service (QoS) system in order to maximize WAN utilization while maintaining priority, latency, and jitter.

## G.1.1 Traffic Optimization

Traffic optimization through payload compression is provided on the ODM-840 using Comtech AHA Enterprise Products Group compression technology via its installed ASIC. The ODM-840 ostensibly supports a hardware-accelerated compression algorithm based on GZIP, a file format standard where the underlying compression algorithm is called **Deflate**. Deflate is a compression algorithm that is widely available as an open-source software tool; it does not require the use of a software license.

Deflate-compressed blocks are wrapped with a header and footer to become GZIP files. Typically, when a classical, single, general purpose CPU performs GZIP compression, the compression performance is scaled back either to maximize data throughput speeds, or the CPU runs slow.

To negate either deficiency, an efficient solution is to offload the compression task to a hardware-based GZIP function, as is accomplished with the ODM-840. Hardware-based GZIP compression offloads lossless data compression and frees up the system's main CPUs. This allows the compression functions to operate not only independently, but also at much higher data rates if needed. The ASIC takes in uncompressed input data, compresses it, and outputs the data in compressed form.

The compression hardware does many tasks in parallel, only offloaded from the central CPUs of the ODM-840. This effectively eliminates the multi-pass and iterative nature typical of a classical, single, general purpose CPU that is over tasked with executing the Deflate algorithm.

## G.1.2 Compression Performance

Compression performance is classically measured by two metrics – size reduction and data throughput:

- Size reduction is usually reported as a ratio of the uncompressed original size divided by the compressed size.
- Data throughput is measured in bytes per second (bps) as measured on the uncompressed side of the GZIP ASIC.

Data complexity has no effect on data throughput. Easy-to-compress data files that compress with a high ratio pass through the co-processor at the same high data rate as very complex data, which achieves lower compression ratios.

**Table G-1** provides Comtech AHA GZIP compression ratio results as compared with the Calgary Corpus and Canterbury Corpus industry standard file sets and algorithms. The HTML file set is from a collection of Internet dynamic content; LZS (Lempel-Ziv-Stac) compression results are based on publicly available descriptions of the LZS algorithm.

**Table G-2** outlines the comparison the effects of the CTOG specification for current operation, based on a session-based compression for which the current performance specifications are given.

**Table G-1. Comtech AHA GZip Performance Comparisons**

File Sets	Comtech AHA363-PCle	LZS	ALDC
Calgary Corpus	2.7:1	2.2:1	2.1:1
Canterbury Corpus	3.6:1	2.7:1	2.7:1
HTML	4.4:1	3.4:1	2.65:1

**Table G-2. Comtech AHA GZip Performance Specifications Support**

Description	Specification
Number of TX compression sessions supported	64,000
Session history size supported	2048
Granularity of control	Per route basis
Refresh rate	1 to 600 packets or 1 second whichever comes first
Compatibility	Packets compressed by the ODM-840 transmitter will be decompressed without error by the ODM-840 receiver.

---

## G.2 ODM-840 Header and Payload Compression Operation

The ODM-840 provides several means for configuring Header and Payload Compression Carrier ID operation via Remote Product Control with a user-supplied PC:

- ODM-840 HTTP (Web Server) Interface using a compatible Web browser.
- Ethernet-based Simple Network Management Protocol (SNMP) using a Network Management System (NMS) and Management Information Base (MIB) File Browser.



**COMTECH EF DATA RECOMMENDS USE OF THE ETHERNET-BASED SNMP INTERFACE ONLY FOR ADVANCED USERS. COMTECH EF DATA STRONGLY ENCOURAGES USE OF THE ODM-840 HTTP INTERFACE FOR MONITOR AND CONTROL (M&C) OF THE ODM-840. THE HTTP INTERFACE FIGURES AS FEATURED THROUGHOUT THIS APPENDIX ARE INTENDED FOR USER REFERENCE ONLY AND ARE SUBJECT TO CHANGE. THE FIRMWARE INFORMATION (I.E., REVISION LETTERS, VERSION NUMBERS, ETC.) AS DISPLAYED MAY DIFFER FROM YOUR SETUP.**

### G.2.1 Compression Operation – ODM-840 HTTP Interface



**Chapter 6. ETHERNET-BASED REMOTE PRODUCT MANAGEMENT**



**YOU MAY PROCEED WITH ETHERNET-BASED REMOTE PRODUCT MANAGEMENT (WEB SERVER OR SNMP), ASSUMING THAT:**

- **YOU ARE OPERATING THE ODM-840 IS OPERATING WITH THE LATEST VERSION FIRMWARE FILES.**
- **YOU HAVE CONNECTED THE ODM-840 TO A USER-SUPPLIED, WINDOWS-BASED PC AS FOLLOWS:**
  - **THE PC SERIAL PORT IS CONNECTED TO THE ODM-840 ‘CONSOLE/ REDUNDANCY’ PORT WITH A USER-SUPPLIED 19-PIN-TO-9-PIN ADAPTER SERIAL CABLE.**
  - **THE PC ETHERNET PORT IS CONNECTED TO THE ODM-840 ‘ETHERNET T/M’ ETHERNET PORT WITH A USER-SUPPLIED HUB, SWITCH, OR DIRECT WEATHERPROOF ETHERNET CABLE CONNECTION.**
  - **THE PC IS RUNNING A TERMINAL EMULATION PROGRAM (FOR OPERATION OF THE ODM-840 SERIAL INTERFACE) AND A COMPATIBLE WEB BROWSER (FOR OPERATION OF THE ODM-840 HTTP INTERFACE).**
- **YOU HAVE NOTED THE ODM-840 MANAGEMENT/TRAFFIC IP ADDRESS USING THE ODM-840 SERIAL INTERFACE.**

**Figure G-1** shows the menu tree for accessing Header and Payload Compression under the ODM-840 HTTP Interface. Page functionality that is not specific to ODM-840 Header and Payload Compression operation appears dimmed.

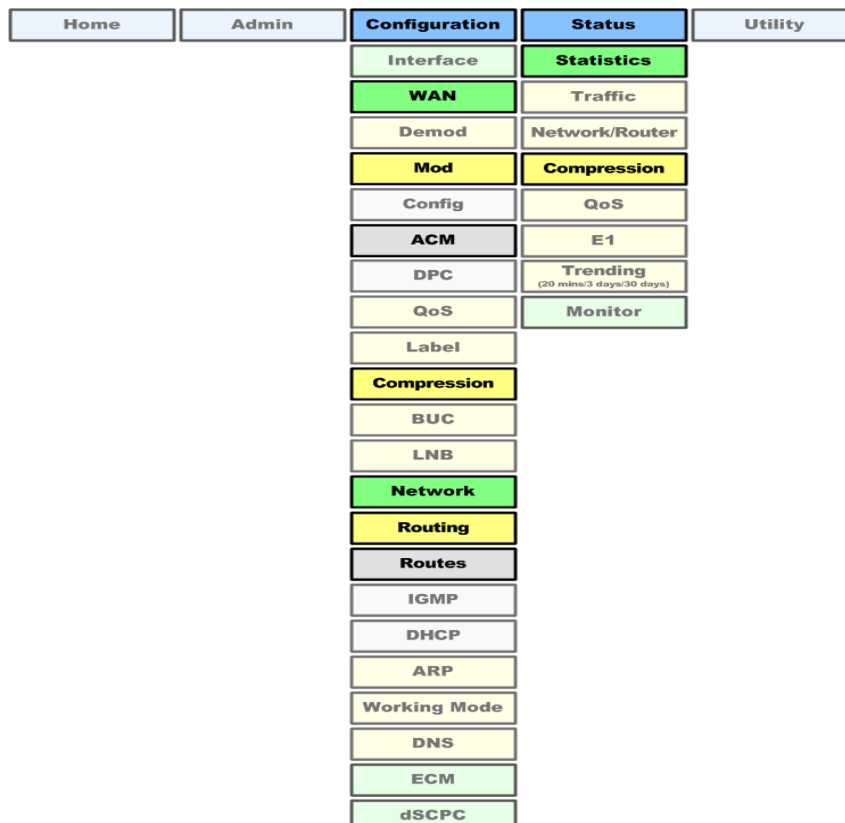
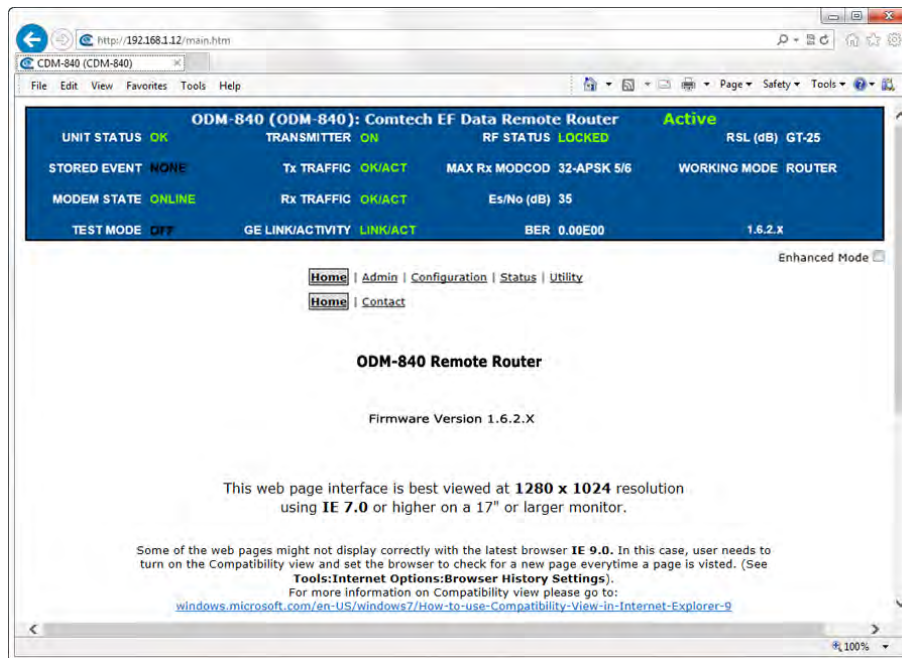

**Figure G-1. HTTP Interface Menu Tree – Compression Operations (FW Ver. 1.6.2.X)**

## G.2.2 Enable or Disable Header and Payload Compression Operation

Use the 'Configuration | Network | Routing | Routes' page (Figure G-2) to enable or disable Header and Payload Compression operation when operating in Router Mode.

**Add New Route**

Index	Description	Dest. IP/Mask	Interf.	Next Hop IP	Header Comp.	Payload Comp.
2			To WAN	0.0.0.0	Disabled	Disabled

**Delete Route**

Enter Route Index to Delete

**Route Table (Edit)**

Index	Description	Dest. IP/Mask	Interf.	Next Hop IP	Header Comp.	Payload Comp.	
1	default	0.0.0.0/0	To WAN	N/A	Disabled	Disabled	Change

**Figure G-2. Configuration | Network | Routing | Routes Page**

When **enabled**, the ODM-840 automatically identifies supported packets for Header Compression. The only configurable settings are the Header and Payload Compression Refresh Rates.



Header and Payload Compression is independent from QoS. The enabling or disabling of this feature is required only on the sending Comtech EF Data VSAT products (CDM-840, ODM-840, CTOG-250/CDM-800 or standalone CDM-800 for FW Versions V1.5.1 or older). The need to Header and Payload Decompress incoming packets on the ODM-840 or CDD-880 is automatic and transparent to the user.



### G.2.3 Configure Header and Payload Compression Refresh Rates

Use the ‘**Configuration | WAN | Compression**’ page (Figure G-3) to define the Header and Payload Compression Refresh Rates. These settings control how many compressed header packets are sent before a single full header packet is sent.



**Bridge Point-to-Multipoint (BPM) Mode, a feature available with the CDM-840 Remote Router, is not available with the ODM-840. The “Bridge Point-to-Multipoint (BPM) Mode Configuration” section of this page is therefore non-functional.**

**Figure G-3. Configuration | WAN | Compression page**

The supported refresh rates are based on the runtime characterization that there will be, at most, 600 packets seen between refreshes. Additionally, even though the runtime supports 64,000 Tx compression sessions, it is only necessary to have context storage for a small number over those 600 packets. Based on this specification, the ODM-840’s compression performance is defined in **Table G-3** ( $\pm 5\%$  with different compression refresh rates).

**Table G-3. Compression Performance**

Packet Size	% Savings per Compression Refresh Rate				
	1	25	50	300	600
40	23%	50%	53%	53%	55%
420	40%	51%	51%	51%	51%
800	46%	53%	53%	53%	53%
1200	49%	54%	54%	53%	54%
1472	50%	55%	55%	55%	55%



**While some compressed header traffic can be lost during deteriorated satellite link conditions, the ODM-840 tries to minimize that when Adaptive Coding and Modulation (ACM) is enabled (Figure G-4). Sending a full packet allows the return of the traffic stream; you may increase the Refresh Rate (smaller value) when poor satellite link conditions are prevalent or, conversely, decrease the rate (larger value) under clear sky condition operations.**

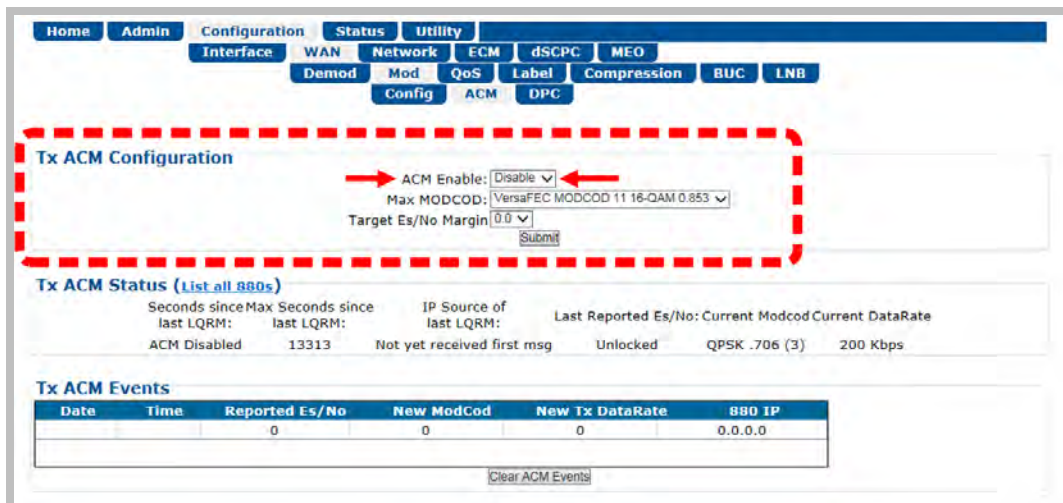

Figure G-4. Configuration | WAN | MOD | ACM Page

## G.2.4 View Header and Payload Compression Statistics

Use the ‘Status | Statistics | Compression’ page (Figure G-5) to review Header and Payload Compression statistics – the total bytes of the pre-compressed and post-compressed traffic and effective compression ratio.

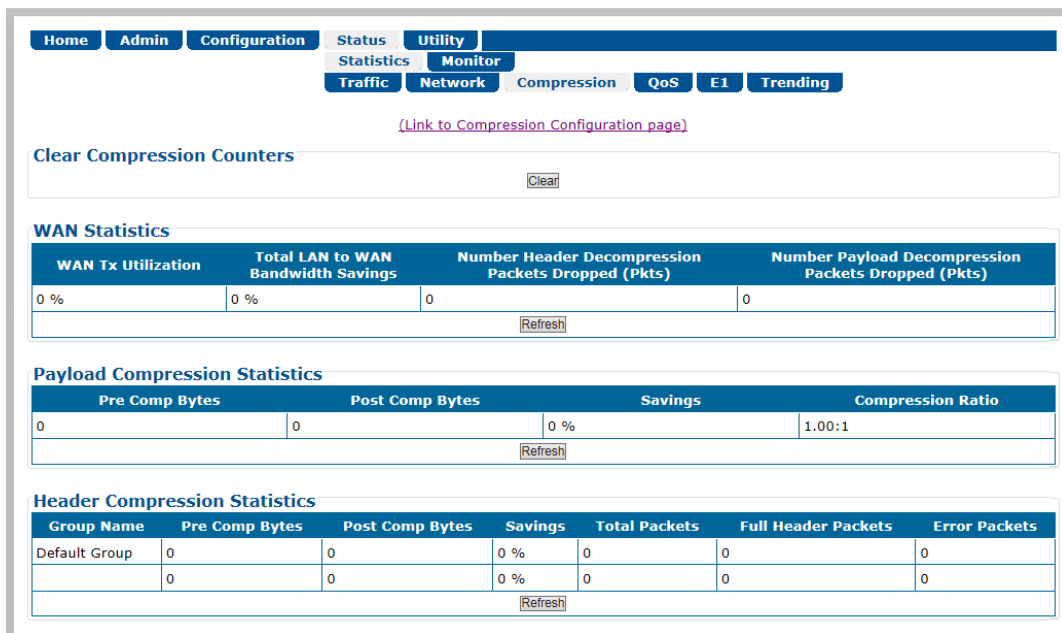

Figure G-5. Status | Statistics | Compression Page

The ODM-840 supports header compression for Ethernet, and Layer 3, 4, and 5 headers.



The ODM-840 supports Router Mode operation only, so Layer 2 headers are not transmitted over the satellite link. Therefore, there is no need for Layer 2 header compression.

Supported Ethernet Headers		
• Ethernet 2.0	• 803.3+802.2+SNAP+VLAN tag	• 803.3+802.2+SNAP
• Ethernet 2.0+MPLS	• Ethernet 2.0+VLAN tag	• 803.3+SNAP+MPLS
• 802.3-raw+VLAN tag	• 802.3-raw	
• 803.3+802.2+VLAN tag	• 803.3+802.2	

Supported Layer 3 and Layer 4 Headers		
• IP	• TCP	
• RTP (Codec Independent)	• UDP	



# Appendix H. RETURN GROUP QoS (QUALITY OF SERVICE)



**UNLESS OTHERWISE NOTED** – This appendix collectively refers to the Comtech EF Data Advanced VSAT Series ODM-840 Remote Router, ODMR-840 Reduced Form Factor Remote Router, and ODMR-840B Remote Router Board Set as the ODM-840.

---

## H.1 Overview

Quality of Service (QoS) enables a network to use WAN bandwidth more efficiently by managing delay, jitter (delay variation), throughput, and packet loss. The ODM-840 Remote Router provides Return 2-level Group QoS while classifying packets up to Layer 4 (the Transport Layer) of the Open Systems Interconnection (OSI) Model.

QoS is fully integrated with ACM (Adaptive Coding and Modulation), dSCPC (Dynamic Single Carrier Per Channel), and header and payload compression to achieve highest bandwidth utilization while providing desired levels of service.

### H.1.1 QoS Terminology

- **CIR** – CIR (Committed Information Rate) is used to reserve capacity through the QoS system. CIR is entered in kbps but is enforced in 1k Bytes per second increments. The CIR will be honored unless there is not enough bandwidth/symbols on the transmitter.
- **CIR Availability** – The reported CIRs Availability statistics is the percentage of time over the last 1, 15 or 60 minutes for which the CIR was demanded of the QoS system and the system was able to honor the packet throughput demand. CIR Availability is intended to provide a metric for operators to trend over time to determine if there is enough satellite bandwidth allocated to meet customer demands. This metric allows operators the ability to “safely” oversubscribe the satellite bandwidth purchased.
- **Clipping** – The process of the QoS Scheduler’s discard of packets, when the traffic level for a queue exceeds the Max BW (Maximum Bandwidth) or MIR (Maximum Information Rate).
- **Jitter** – The amount of variation that is measured, in milliseconds, between two consequent frames at the receiving end.

- **Latency** – The time it takes for a packet to be transmitted, as measured from one point to another. For the purposes of Advanced VSAT, latency is the amount of delay that is measured, in milliseconds, from the Ethernet interface of the near-end modem to the Ethernet interface of the far-end modem.
- **Maximum Clipping Rate** – In Max/Pri (Maximum/Priority), Min/Max (Minimum/Maximum), and Pri-Weighted (Priority/Weighted) QoS Control Modes, you can define the maximum amount of data rate to be allocated to a queue. Maximum Clipping Rate can also be referred to as Max BW or MIR.
- **Priority** – In Max/Pri and Pri-Weighted QoS Control Modes, you may define a Priority level of 1 through 8 for a flow. For example, a Priority 1 queue schedules and drains before a Priority 2 queue; similarly, Priority 2 packets will schedule and drain before Priority 3 packets, etc.
- **QoS Queue Size** – The QoS queue size varies and is equal to 1 second's worth of TX data at the current data rate.
- **Round-robin** – The simplest scheduling process, where all packets are equal in priority and are processed in the order they arrive.
- **Tail Drop** – The process of discarding packets when a queue is full. Tail Drop is the most basic queue management process where all packets are treated identically and newly arriving packets are dropped while the queue is at capacity.
- **Traffic Shaping** – Also known as 'packet shaping,' this is the practice of regulating network data transfer to assure a certain level of QoS for some applications or users or to increase available bandwidth for some other purpose.
- **Weight** – This is the user-configurable parameter when using Pri-Weighted QoS Control Mode. The valid Weight ranges are 1 through 9 – the greater the Weight, the higher the precedence will be given to that queue when draining packets.

For example, given the same Priority Level, more bytes would be drained from those with Weight = 9 than those with Weight = 8, and so on.

- **Weighted Scheduling** – Used in Pri-Weighted Mode. The QoS Scheduler calculates each quantum based on available bandwidth, total weights, and per queue value as follows:  
Per queue quantum = available bandwidth \*(per queue weight/total weights)
- **WRED** – Weighted Random Early Detection is a congestion avoidance algorithm that is better at avoiding network congestion than using Tail Drop, particularly for TCP traffic.

### H.1.2 QoS List of Supported RFCs (Requests for Comment)

RFC No.	Description
2474	"Definition of the Differentiated Services Field (DS Field) in the IPv4 and IPv6 Headers" Nichols, K., Blake, S., Baker, F. and D. Black, December 1998
2475	"An Architecture for Differentiated Services" Blake, S., Black, D., Carlson, M., Davies, E., Wang, Z. and Weiss, W., December 1998
2597	"Assured Forwarding PHB" Heinanen, J., Baker, F., Weiss, W. and J. Wrocklawski, June 1999
2598	"An Expedited Forwarding PHB" Jacobson, V., Nichols, K. and K. Poduri, June 1999

### H.1.3 Return 2-Level Group QoS

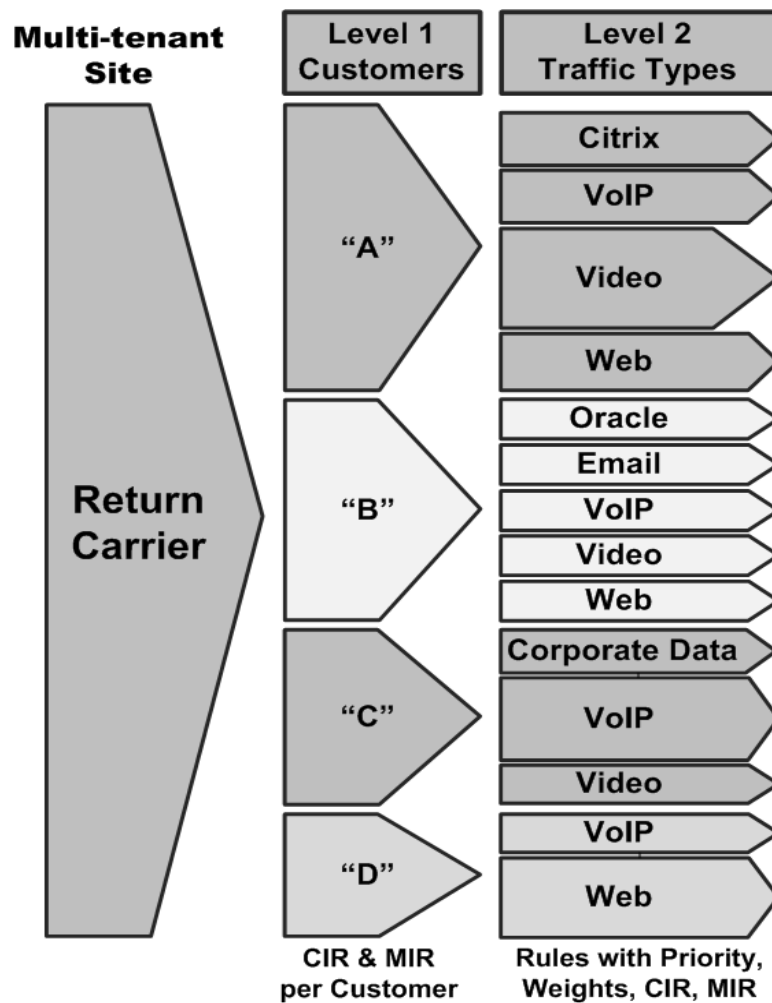
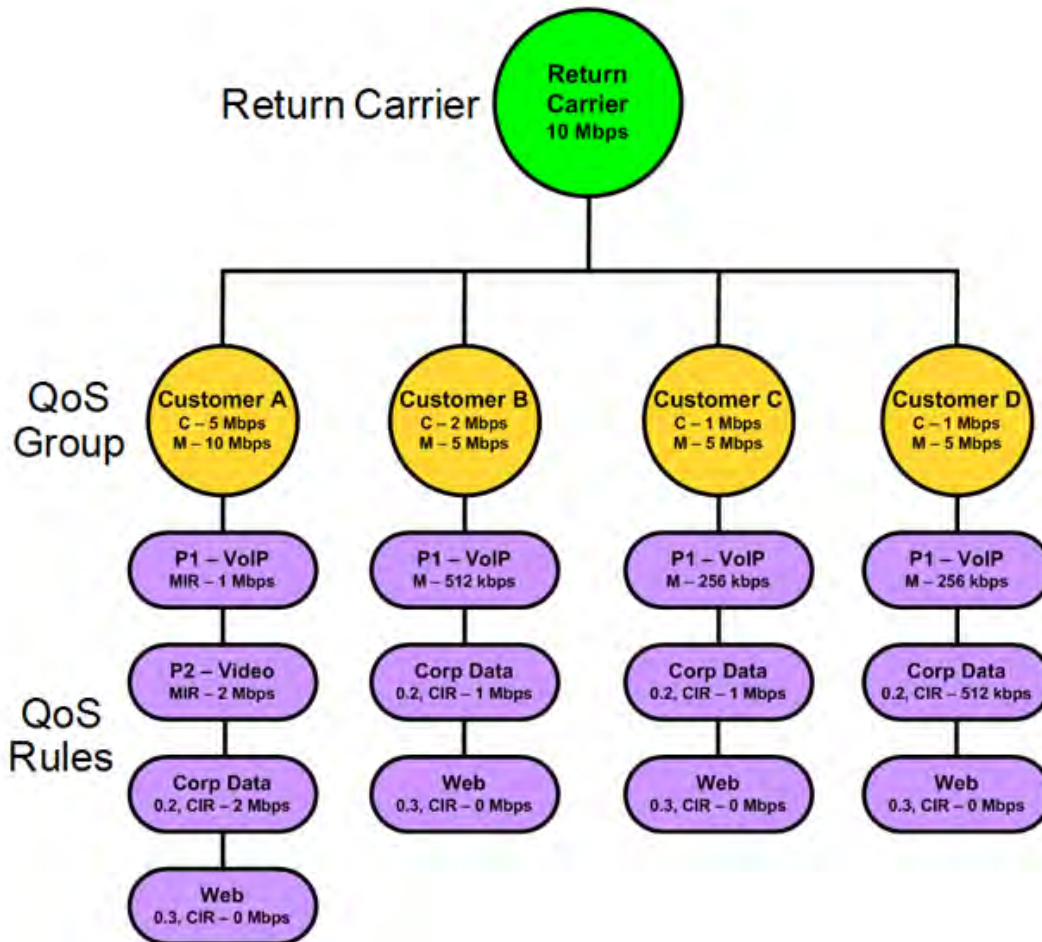

**Figure H-1. Group QoS Multi-tenant Site Return QoS**

Comtech EF Data's Advanced VSAT supports Return 2-level Group QoS to allow a service provider to support multi-user, multi-tenant sites where each customer can be assigned a share of the return capacity as CIR (Committed Information Rate) and MIR (Maximum Information

Rate). As shown in **Figure H-1**, Return 2-level Group QoS allows efficient bandwidth sharing and prioritization among customer sites, and traffic types:

- Level 1 allows different customers to share and prioritize bandwidth allocation among them.
- Level 2 allows different applications and traffic types to be prioritized by a customer.
- Traffic shaping is supported with multi-tier QoS.



**Figure H-2. Group QoS for Multi-tenant Site 2-Level Return QoS Configuration**

As shown in **Figure H-2**, the Return Carrier is divided into QoS Groups. Each customer may create multiple QoS Groups, with rules within their assigned capacity to manage different applications and traffic types.

You may assign up to 31 QoS Rules per Group. A “rule” is a powerful classifier, whereby packets are sorted (“classified”) based on TOS (Type of Service); Protocol (Application); Source and Destination IP Addresses/Subnets; and Source and Destination Port range.

- Defined by IP Subnet(s) – 31 Subnets per QoS Group;



- Configure the CIR, MIR, and QoS Control Mode for each QoS Group;
- Each QoS Group supports these QoS Control Modes:
  - **Max/Pri (Maximum/Priority)** – Provides multi-level traffic prioritization with the ability to limit maximum traffic per priority class. See **Sect. H.2.2.1** for details.
  - **Min/Max (Minimum/Maximum)** – Provides a Committed Information Rate (CIR) to each user defined class of traffic with the ability to allow a higher rate (MIR) depending on bandwidth availability. See **Sect. H.2.2.2** for details.
  - **Pri-Weighted (Priority/Weighted)** – Allows for a combination of priorities and weights with CIR. See **Sect. H.2.2.3** for details.
  - **DiffServ (Differentiated Services)** – Industry-standard method that enables seamless co-existence in networks that implement DiffServ. See **Sect. H.2.2.4** for details.
- Associates Remotes to QoS Groups for ACM/VCM.

An incoming packet is mapped to a QoS Group based on Matching Subnet.

The system collects extensive statistics that can be used to monitor performance in real time, or stored for historical analysis. This includes entire Outbound Statistics; QoS Group Statistics; and Per-Rule Statistics. See **Sect. H.5** for details.

## H.1.4 QoS Operation via Remote Product Control

The ODM-840 provides several means for configuring QoS operation via Remote Product Control with a user-supplied PC:

- ODM-840 HTTP (Web Server) Interface using a compatible Web browser.
- Ethernet-based Simple Network Management Protocol (SNMP) using a Network Management System (NMS) and Management Information Base (MIB) File Browser.



### Chapter 6. ETHERNET-BASED REMOTE PRODUCT MANAGEMENT



#### YOU MAY PROCEED WITH ETHERNET-BASED REMOTE PRODUCT MANAGEMENT (HTTP OR SNMP), ASSUMING THAT:

- **YOUR ODM-840 IS OPERATING WITH THE LATEST VERSION FIRMWARE FILES.**
- **YOUR ODM-840 IS CONNECTED TO A USER-SUPPLIED, WINDOWS-BASED PC AS FOLLOWS:**
  - **THE PC SERIAL PORT IS CONNECTED TO THE ODM-840 ‘CONSOLE/ REDUNDANCY’ PORT WITH A USER-SUPPLIED 19-PIN-TO-9-PIN ADAPTER SERIAL CABLE.**
  - **THE PC ETHERNET PORT IS CONNECTED TO THE ODM-840 ‘ETHERNET T/M’ ETHERNET PORT WITH A USER-SUPPLIED HUB, SWITCH, OR DIRECT WEATHERPROOF ETHERNET CABLE CONNECTION.**
  - **THE PC IS RUNNING A TERMINAL EMULATION PROGRAM (FOR OPERATION OF THE ODM-840 SERIAL INTERFACE) AND A COMPATIBLE WEB BROWSER (FOR OPERATION OF THE HTTP INTERFACE).**
- **YOU HAVE NOTED THE ODM-840 MANAGEMENT /TRAFFIC IP ADDRESS USING THE ODM-840 SERIAL INTERFACE.**
- **COMTECH EF DATA RECOMMENDS USE OF THE SERIAL-BASED REMOTE CONTROL INTERFACE AND THE ETHERNET-BASED SNMP INTERFACE ONLY FOR ADVANCED USERS. COMTECH EF DATA STRONGLY ENCOURAGES USE OF THE ODM-840 HTTP INTERFACE FOR MONITOR AND CONTROL (M&C) OF THE ODM-840.**

Figure H-3 shows the ODM-840 HTTP Interface “splash” page, and the menu tree for accessing the operations specified in this appendix. Page functionality that is not specific to QoS operation appears dimmed.

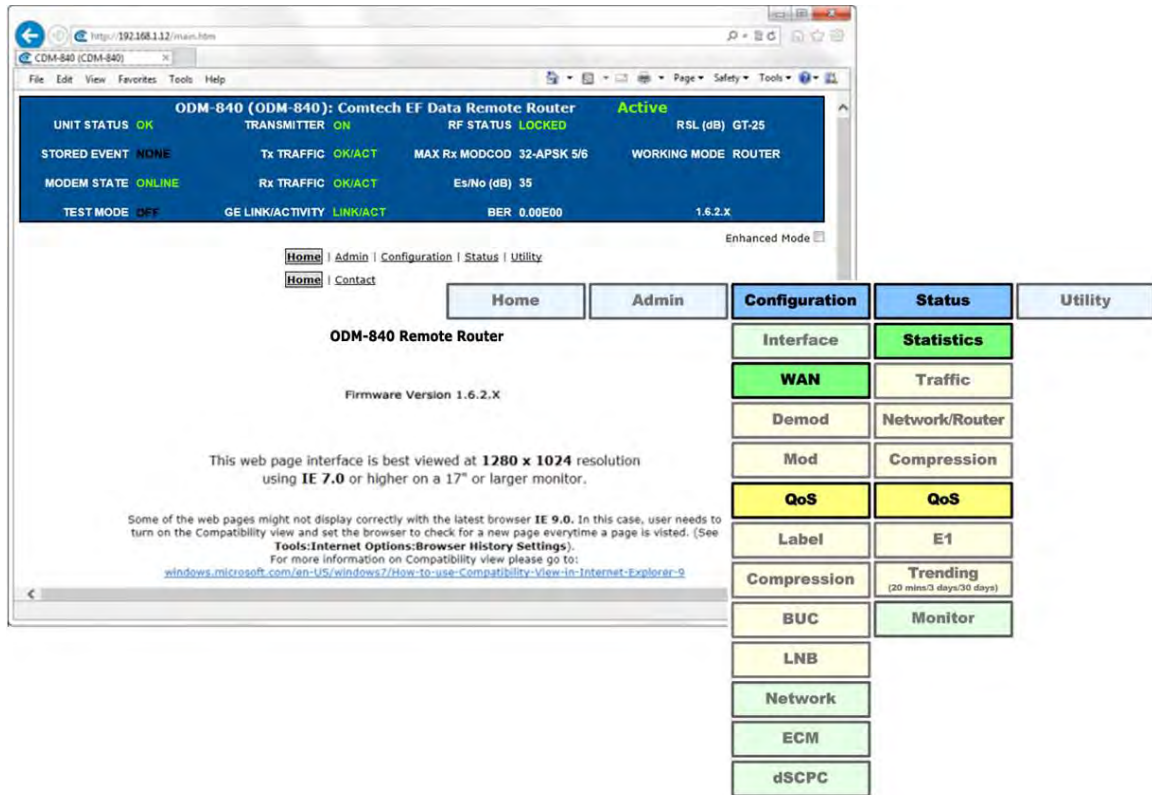

Figure H-3. ODM-840 HTTP Interface and Menu Tree (FW Ver. 1.6.2.X)

## H.2 QoS Groups

Including the default queue, each QoS Group has up to 32 QoS Rules with eight configurable priorities. The QoS systems:

- Create a separate queue for each rule to store the incoming stream of packets. (In this appendix, 'QoS rules' and 'QoS queues' are interchangeable.)
- Use a strict priority QoS scheduling algorithm. For QoS Group priority numbering, the *lower* the priority number, the *higher* the priority. For example, a Priority 1 queue schedules and drains before a Priority 2 queue; similarly, Priority 2 packets will schedule and drain before Priority 3 packets, etc.

Each QoS queue is implemented to support at least one (1)-second burst at the maximum data rate of the Tx Carrier of the modem.

- Incorporate WRED (Weighted Random Early Detection) based congestion avoidance algorithm in addition to tail drop. WRED is designed to avoid congestion by progressively increasing the chance of an incoming packet being dropped once the QoS queue has reached 50% of capacity. After the queue is 50% full, then the random chance of dropping a packet increasing up to 100% when the queue is full.

## H.2.1 QoS Group Matching

QoS Group Matching allows you to match an incoming packet to the desired QoS Group. Once a packet has been matched to a QoS Group, then the configured QoS Rule Matching criteria are used to determine where the packet is inserted into the QoS queue.

Note that QoS Group Matching is global across all QoS Groups. You must make sure that the QoS Groups throughout the system do not share the same matching criteria. The FW Ver. 1.6.2.X Packet-to-QoS Group Matching criteria is as follows (by order of preference):

1. Matching Subnet
2. Default QoS Group

Matching is absolute, not partial. If a QoS Group has a Subnet attribute, then the traffic must match the attribute to be classified to use the group. Classification starts with the most stringent matching criteria (Subnet) and continues down the hierarchy until a match is found. If there is more than one QoS Group with the same attributes (which should be avoided), the last matching QoS Group will be used.

## H.2.2 QoS Group Control Modes



Chapter 6.3.3.2.3 Configuration | WAN | QoS (Quality of Service) in Chapter 6. ETHERNET-BASED REMOTE PRODUCT MANAGEMENT

The screenshot displays the configuration page for QoS groups. At the top, there are navigation tabs: Home, Admin, Configuration, Status, and Utility. Under Configuration, there are sub-tabs for Interface, WAN, Network, ECM, dSCPC, and MEO. Further down, there are more specific tabs: Demod, Mod, QoS, Label, Compression, BUC, and LNB. A link "(Link to QoS Statistic page)" is present.

The main content area is divided into several sections:

- Add/Change/Delete Group:** This section contains a form with fields for Index Name, CIR (kbps), MIR (kbps), and Mode. The Mode is currently set to "DiffServ". There are "Add", "Change", and "Delete" buttons.
- Group Table:** A table listing the configured QoS groups.

Index	Name	CIR (kbps)	MIR (kbps)	Mode	Select
1	Default Group	0	Maximum	Off	<input checked="" type="radio"/>
- Add/Delete Per Group Attribute:** This section has radio buttons for "VLAN" and "Subnet" (which is selected). It includes "Add" and "Delete" buttons.
- Subnet Attributes:** A table with columns for Index, Type, and Value.

At the bottom of the page, a status indicator reads "QoS Mode is Off".

**Figure H-4. Configuration | WAN | QoS | QoS Page (Control Mode = Off)**

Use the ODM-840 HTTP Interface 'Configuration | WAN | QoS' page (Figure H-4) to manage QoS Groups. In the **Add/Change/Delete Group** section of the page, use the drop-down list to select the desired QoS Control Mode: Max/Pri, Min/Max, Pri-Weighted, or DiffServ. Click **[Change]** to proceed.

## H.2.2.1 QoS Group Max/Pri Control Mode

In *Max/Pri* Control Mode, you may configure up to 31 QoS rules using TOS, Protocol (Application), Source and Destination IP Addresses/Subnets, and Source and Destination Port range in order to match packets to the desired QoS rule. For each created rule, you can also set the QoS treatments such as Priority, limiting the Maximum Bandwidth, enable or disable WRED, and enable or disable the FILTER ALL rule.

When you enable WRED for a specific queue, QoS randomly drops packets after reaching 50% of the QoS queue capacity.

When you enable the FILTER ALL option for a rule, QoS provides the ability to filter the packet completely. In other words, all packets matching the QoS Rule with the FILTER ALL option enabled will be dropped.

For example, using the ODM-840 HTTP Interface ‘Configuration | WAN | QoS’ page:

1. Select Max/Pri as the QoS Group Control Mode.
2. Set the Modem Tx bandwidth to 2048 kbps.
3. Configure the Max/Pri QoS rules as follows:

Index	VLAN Range	TOS	Protocol	Src IP/ Mask	Dest IP/ Mask	Min Src Port	Max Src Port	Min Dst Port	Max Dst Port	Max BW (kbps)	Priority	WRED	Filter All
1	N/A	255	UDP	*/*	*/*	0	65535	0	65535	644	1	N	N
2	N/A	255	TCP	*/*	*/*	0	65535	0	65535	99999	2	N	N
3	N/A	255	HTTP	*/*	*/*	0	65535	0	65535	99999	3	N	N
4	N/A	255	Def	*/*	*/*	0	65535	0	65535	99999	9	N	N



When using the Add/Delete Per Group QoS Rule table, note that QoS Rules match from left to right, with the TOS being the highest match, and the Destination Port range being the lowest match. Matches can be made using multiple attributes. Use of VLAN IDs requires Bridge Point-to-Multipoint Mode, a feature used with the CDM-840 that is NOT available with the ODM-840.

4. The input data streams are as follows:

Stream	VLAN Range	TOS	Protocol	Src IP/Mask	Dest IP/Mask	Src Port	Dest Port	Stream Data Rate (kbps)
1	N/A	255	UDP	*/*	*/*	***	***	1024
2	N/A	255	TCP	*/*	*/*	***	***	1024
3	N/A	255	HTTP	*/*	*/*	***	***	1024
4	N/A	255	IP	*/*	*/*	***	***	64

**QUESTION:** What are the total output data rates and the individual stream data rates?

**ANSWER:** The individual stream data rates are as follows:

QoS Rule	QoS Group Priority	Input Data Rate (kbps)	QoS Output Data Rate (kbps)	Remain Data Rate (kbps) (After Serving the Priority Queue)
1	1	1024	644 due to max clipping	1404
2	2	1024	1024	380
3	3	1024	380	0
4	9	64	0	0
<b>Total ▶</b>		<b>3136</b>	<b>2048</b>	<b>0</b>

## H.2.2.2 Group Min/Max Control Mode

In *Min/Max* Control Mode, you may configure up to 32 QoS rules using TOS, Protocol (Application), Source and Destination IP Addresses/Subnets, and Source and Destination Port range in order to match packets to the desired QoS rule. For each created rule, you can also set the QoS treatment, such as guaranteed minimum bandwidth (Committed Information Rate, or *CIR*), maximum clipping bandwidth (MIR), enable or disable WRED, and enable or disable the FILTER ALL rule.

When you enable WRED for a specific queue, QoS randomly drops packets after reaching 50% of the QoS queue.

When you enable the FILTER ALL option for a rule, QoS provides the ability to filter the packet completely. In other words, all packets matching the QoS Rule with the FILTER ALL option enabled will be dropped.

**For example, using the ODM-840 HTTP Interface ‘Configuration | WAN | QoS’ page:**

1. Select Min/Max as the QoS Group Control Mode.
2. Set the Modem Tx bandwidth to 20000 kbps.
3. Configure the Min/Max QoS rules as follows:

Index	VLAN Range	TOS	Protocol	Src IP/ mask	Dest IP/ mask	Min Src Port	Max Src Port	Min Dst Port	Max Dst Port	Min BW (kbps)	Max BW (kbps)	Priority	WRED	Filter All
1	N/A	255	UDP	***/*	***/*	0	65535	0	65535	2500	4000	8	N	N
2	N/A	255	TCP	***/*	***/*	0	65535	0	65535	2500	99999	8	N	N
3	N/A	255	HTTP	***/*	***/*	0	65535	0	65535	0	99999	8	N	N
4	N/A	255	Def	****/*	****/*	0	65535	0	65535	0	99999	9	N	N



**When using the Add/Delete Per Group QoS Rule table, note that QoS Rules match from left to right, with the TOS being the highest match, and the Destination Port range being the lowest match. Matches can be made using multiple attributes. Use of VLAN IDs requires Bridge Point-to-Multipoint Mode, a feature used with the CDM-840 that is NOT available with the ODM-840.**

4. The input data streams are as follows:

Stream	VLAN Range	TOS	Protocol	Src IP/ Mask	Dest IP/Mask	Src Port	Dest Port	Stream Data Rate (kbps)
1	N/A	255	UDP	*/*	*/*	***	***	10000
2	N/A	255	TCP	*/*	*/*	***	***	5000
3	N/A	255	HTTP	*/*	*/*	***	***	7000
4	N/A	255	DEF	*/*	*/*	***	***	10000

**QUESTION:** What are the total output data rates and the individual stream data rates?

**ANSWER:**

- In Min/Max QoS Control Mode, other than the default rule (which is configured as Priority 9), all QoS rules are configured at the same priority (Priority 8).
- In this mode, the minimum bandwidth (CIR) for all rules – excluding the default rule – will be served *first* in *Round-robin* fashion.

In this example, the total minimum bandwidth for Rules 1 and 2 is 5000 kbps. Since the total bandwidth is 20000 kbps, it has enough bandwidth to serve.

- After serving the minimum bandwidth, the leftover bandwidth is 15000 kbps (20000 – 5000 = 15000).
- Leftover bandwidth will be served among all rules in Round-robin fashion until it hits maximum bandwidth limitations.
- Each rule’s bandwidth is 15000 / 3 = 5000 kbps.
- Since Rule 1 maximum clipping was set to 4000 kbps, and minimum bandwidth has already taken 2500 bytes, it will use 1500 kbps more before reaching the maximum clipping. The leftover 3500 kbps (5000 – 1500 = 3500) is again given to the main pool.
- Rule 2 does not have enough traffic coming in, so it will use only 2500 kbps (5000 – 2500 = 2500); the remaining bandwidth (5000 – 2500 = 2500) is again given to the main pool.
- Rule 3’s input stream is 7000 kbps; it will take its share of the 5000 kbps allocation. Still, it needs 7000 – 5000 = 2000.
- After serving the fair share, the total leftover bandwidth is 6000 kbps (3500 + 2500 = 6000).
- Since Rule 3 needs the bandwidth, the leftover bandwidth is applied to that rule.
- After serving Rule 3, the leftover bandwidth 4000 kbps will be applied to the default queue.
- The default rule will see the data rate of 4000 kbps.

The individual rule's data rates are as follows:

QoS Rule	QoS Group Priority	Input Data Rate (kbps)	QoS Output Data Rate (kbps)
1	1	10000	4000
2	2	5000	5000
3	3	7000	7000
4	9	10000	4000
<b>Total ▶</b>		<b>32000</b>	<b>20000</b>

### H.2.2.3 QoS Group Pri-Weighted Control Mode

In *Pri-Weighted* Control Mode, you may enter the weight while configuring queues, similar to configuring other parameters such as minimum or maximum bandwidth, priority, etc. In this QoS Control Mode, the weight is considered only if multiple queues are configured with the same priority, and at least one of the weights is different from others and the minimum bandwidth has already been achieved. When valid weights are configured in this QoS Control Mode, the weighted scheduling algorithm is applied. In all other cases, Strict Priority and Round-robin scheduling will be applied.

#### H.2.2.3.1 Weight

Weight is a user-configurable parameter. The greater the weight, the higher the precedence will be given to that queue when draining the packets. Weight values range from 1 to 9 and 0 is an invalid value. The Scheduler will drain more bytes from weight 9 queues than weight 8 queues under the same priority, and so on.

#### H.2.2.3.2 Weighted Scheduling

In weighted scheduling mode, the QoS Scheduler calculates each quantum based on available bandwidth, total weights, and per-queue weights as follows:

$$\text{Per queue quantum} = \frac{\text{available bandwidth} * \text{per queue weight}}{\text{total weights}}$$

There are some exceptions when assigning per-queue quantum to each queue, as represented by three cases:

- **Case 1 – The per-queue quantum is greater than the configured maximum bandwidth.**

When the LAN ingress data rate is greater than the maximum bandwidth, the Scheduler drains packets only up to the maximum bandwidth, and then drops the remaining packets. With Case 1, maximum bandwidth is the limiting factor, and weight is not applied.

- **Case 2 – The per-queue quantum is less than the configured maximum bandwidth but more than the configured minimum bandwidth.**

In this scenario, when the available bandwidth is greater than the total minimum bandwidth but less than total maximum bandwidth, the QoS Scheduler first satisfies the minimum



bandwidth for all queues with the same priority, and then divides the remaining bandwidth amongst the queues based on their weight value.

**Case 2 example** – The Pri-Weighted QoS rules are configured as follows:

Queue	Min BW (kbps)	Max BW (kbps)	Delta Max Bytes (Max-Min kbps)	Weight	Allowed BW (kbps)
1	16	32	16	9	–
2	32	64	32	8	–
3	48	128	64	7	–
4	64	64	0	6	–
<b>Total ▶</b>	<b>160</b>	<b>288</b>	<b>112</b>	<b>30</b>	<b>240</b>

The total allowed bandwidth is 240 kbps. The total minimum bandwidth is 160 kbps. *The minimum bandwidth is therefore less than the available bandwidth.*

The QoS Scheduler Calculation Solutions table for the Case 2 example is as follows:

Queue	Round 1			Round 2			Round 'N'			Final (kbps)
	Weight	Given (kbps)	Leftover (kbps)	Weight	Given (kbps)	Leftover (kbps)	Weight	Given (kbps)	Leftover (kbps)	
1	9	30	14	–	–	–	–	–	–	16
2	8	26.672	–	8	7.472	2.144	–	–	–	32
3	7	23.328	–	7	6.528	–	7	2.144	–	32
4	–	–	–	–	–	–	–	–	–	–
<b>Total ▶</b>	<b>24</b>	<b>80</b>	<b>14</b>	<b>15</b>	<b>14</b>	<b>2.144</b>	<b>7</b>	<b>2.144</b>	<b>0</b>	<b>80</b>

**This table shows the result of the steps taken to calculate the individual allocated bandwidths:**

1. After the minimum bandwidth is satisfied, there is 80 kbps of bandwidth remaining. This leftover bandwidth is distributed to all queues whose maximum bandwidth hasn't been reached. In this example, only Queues 1, 2, and 3 still have an unmet maximum bandwidth.

Since Queue 4's minimum and maximum bandwidths are the same, Queue 4 will be taken out of the algorithm for distributing the remaining quantum.

The remaining total weight is  $(9 + 8 + 7) = 24$ .

2. Each bandwidth share is then calculated based on the remaining total weight (24) and bandwidth availability (10000 bytes) after the minimum bandwidth is served (20000 bytes):
  - Queue 1 =  $10000 * (9 / 24) = 3750$  bytes (30 kbps)
  - Queue 2 =  $10000 * (8 / 24) = 3334$  bytes (26.6 kbps)
  - Queue 3 =  $10000 * (7 / 24) = 2916$  bytes (23.328 kbps)

3. After Round 1 of quantum distribution, Queue 1 requires only 16 kbps (2000 bytes) to reach its maximum bandwidth, hence the remaining 14 kbps (3750 – 2000 = 1750 bytes). Queues 2 and 3 will consume all of the bytes because they have yet to reach their maximum bandwidth.
4. Calculate each bandwidth share based on the total remaining weight (15) and remaining bandwidth of 14 kbps (1750 bytes):
  - Queue 2 =  $1750 * (8 / 15) = 934$  bytes (7.472 kbps)
  - Queue 3 =  $1750 * (7 / 15) = 816$  bytes (6.528 kbps)
5. After Round 2, Queue 2 can be assigned a maximum of 32 kbps (4000 bytes), hence the remaining 2.144 kbps ((3334 – 934) – 4000 = 268 bytes) goes back into pool the pool once more. Queue 3 will consume all of the bytes because it has yet to reach its maximum bandwidth.
6. Calculate each bandwidth share based on the total remaining weight (7) and remaining bandwidth (268 bytes):
  - Queue 3 =  $268 * (7 / 7) = 268$  bytes (2.144 kbps)
7. In the next round (Round 'N'), only Queue 3 has a maximum bandwidth that is not yet. This queue will take the remaining quantum 2.144 kbps (268 bytes). Since there is no more leftover bandwidth, the calculation loop stops here.

**Case 2 Example Summary – After all rounds, each queue's share is as follows:**

- Q1 = 16 kbps ((2000 additional bytes (4000 bytes total))
  - Q2 = 32 kbps ((4000 additional bytes (8000 bytes total))
  - Q3 = 32 kbps ((4000 additional bytes (10000 bytes total))
  - Q4 = 0 kbps (( 0 additional bytes (8000 bytes total))
- **Case 3 – The per-queue quantum is less than the configured maximum bandwidth.**

**Case 3 / Example 1 – The Pri-Weighted QoS rules are configured as follows:**

Queue	Min BW kbps (Bps)	Weight	Allowed BW kbps (Bps)
1	16 (2000)	9	–
2	32 (4000)	8	–
3	48 (6000)	7	–
4	64 (8000)	6	–
<b>Total ▶</b>	<b>160 (20000)</b>	<b>30</b>	<b>40 (5000)</b>

Each queue is configured with minimum bandwidth and weight as specified in this table. The total allowed bandwidth is 40 kbps (5000 Bps).

The QoS Scheduler Calculation Solutions table for Case 3 / Example 1 is as follows:

Queue	Round 1			Round 2			Round 'N'			Final kbps
	Weight	Given (kbps)	Leftover (kbps)	Weight	Given (kbps)	Leftover (kbps)	Weight	Given (kbps)	Leftover (kbps)	
1	9	12	–	–	–	–	–	–	–	12
2	8	10.672	–	–	–	–	–	–	–	10.672
3	7	9.328	–	–	–	–	–	–	–	9.328
4	6	8	–	–	–	–	–	–	–	8
<b>Total ▶</b>	<b>30</b>	<b>40</b>	<b>0</b>	<b>0</b>	<b>0</b>	<b>0</b>	<b>0</b>	<b>0</b>	<b>0</b>	<b>40</b>

**This table shows the result of the steps taken to calculate the individual allocated bandwidths:**

1. Calculate the bandwidth for each queue based on the total weight (30) and the available bandwidth of 40 kbps (5000 bytes).
  - Queue 1 =  $5000 * (9 / 30) = 1500$  bytes (12 kbps)
  - Queue 2 =  $5000 * (8 / 30) = 1334$  bytes (10.672 kbps)
  - Queue 3 =  $5000 * (7 / 30) = 1166$  bytes (9.328 kbps)
  - Queue 4 =  $5000 * (6 / 30) = 1000$  bytes (8 kbps)

***After Round 1, all bandwidth is consumed and the calculation loop stops.***

**Case 3 Example 1 Summary – Each queue’s share is as follows:**

- Queue 1 = 1500 bytes (12 kbps)
- Queue 2 = 1334 bytes (10.762 kbps)
- Queue 3 = 1166 bytes (9.328 kbps)
- Queue 4 = 1000 bytes (8 kbps)

**Case 3 / Example 2 – The Pri-Weighted QoS rules are configured as follows:**

Queue	Min BW kbps (Bps)	Weight	Allowed BW kbps (Bps)
1	8 (1000)	9	–
2	16 (2000)	8	–
3	24 (3000)	7	–
4	32 (4000)	6	–
<b>Total ▶</b>	<b>80 (10000)</b>	<b>30</b>	<b>64 (8000)</b>

Some of the weighted share is more than the minimum configured value. Each queue is configured with minimum bandwidth and the weight as shown in the Case 3 / Example 2 rules table. The total allowed bandwidth is 8000 bytes per second.

The QoS Scheduler Calculation Solutions table for Case 3 / Example 2 is as follows:

Queue	Round 1			Round 2			Round 'N'			Final kbps
	Weight	Given (kbps)	Leftover (kbps)	Weight	Given (kbps)	Leftover (kbps)	Weight	Given (kbps)	Leftover (kbps)	
1	9	12	–	–	–	–	–	–	–	12
2	8	10.762	–	–	–	–	–	–	–	10.762
3	7	9.328	–	–	–	–	–	–	–	9.328
4	6	8	–	–	–	–	–	–	–	8
<b>Total ▶</b>	<b>30</b>	<b>40</b>	<b>0</b>	<b>0</b>	<b>0</b>	<b>0</b>	<b>0</b>	<b>0</b>	<b>0</b>	<b>40</b>

**This table shows the result of the steps taken to calculate the individual allocated bandwidths:**

1. Calculate the bandwidth for each queue based on the total weight (30) and the available bandwidth of 64 kbps (8000 bytes).
  - Queue 1 =  $8000 * (9 / 30) = 2400$  bytes (19.2 kbps)
  - Queue 2 =  $8000 * (8 / 30) = 2133$  bytes (17.064 kbps)
  - Queue 3 =  $8000 * (7 / 30) = 1866$  bytes (14.928 kbps)
  - Queue 4 =  $8000 * (6 / 30) = 1600$  bytes (12.8 kbps)
  
2. After Round 1, only Queues 3 and 4 have yet to reach their minimum bandwidth. Calculate the bandwidth for each queue based on the total weight (13) and the available bandwidth (1534 bytes):
  - Queue 3 =  $1534 * (7 / 13) = 826$  bytes (6.608 kbps)
  - Queue 4 =  $8000 * (6 / 30) = 708$  bytes (5.664 kbps)

***After Round 2, all bandwidth is consumed and the calculation loop stops.***

**Case 3 Example 2 Summary – Each queue’s share is as follows:**

- Queue 1 = 1000 bytes (8 kbps)
- Queue 2 = 2000 bytes (16 kbps)
- Queue 3 = 2692 bytes (21.536 kbps)
- Queue 4 = 2308 bytes (18.464 kbps)

## H.2.2.4 QoS Group DiffServ Control Mode

QoS Group DiffServ is fully compliant to RFC standards. In *DiffServ* Control Mode, the system automatically configures the rules with DSCP code points, priority values, and WRED. You may only configure the service rate and drop precedence levels for Assured Forwarding (ASFD) classes.

Use the ODM-840 HTTP Interface ‘**Configuration | WAN | QoS**’ page for complete management of the DiffServ features. **Figure H-5** shows the page appearance with DiffServ as the selected QoS Control Mode.

The screenshot displays the 'Configuration | WAN | QoS' page. At the top, there are navigation tabs: Home, Admin, Configuration, Status, and Utility. Under 'Configuration', there are sub-tabs: Interface, WAN, Network, ECM, dSCPC, MEO, Demod, Mod, QoS (selected), Label, Compression, BUC, and LNB. A link '(Link to QoS Statistic page)' is visible.

The main content area is divided into several sections:

- Add/Change/Delete Group:** A form with fields for Index Name, CIR (kbps), MIR (kbps), and Mode (DiffServ). It includes 'Add', 'Change', and 'Delete' buttons. A table below shows one entry: Index 1, Name 'Default Group', CIR 0, MIR 'Maximum', Mode 'DiffServ'.
- Add/Delete Per Group Attribute:** A section with radio buttons for 'VLAN' and 'Subnet', and 'Add' and 'Delete' buttons.
- Subnet Attributes:** A table with columns for Index, Type, and Value.
- Group Table:** A table with columns: Index, Name, CIR (kbps), MIR (kbps), Mode, and Select. It shows one entry: Index 1, Name 'Default Group', CIR 0, MIR 'Maximum', Mode 'Off', and a radio button selected.
- DiffServ QoS Rule Table:** A large table with columns: Index, Priority, Per-Hop Behavior (PHB), Codepoint (DSCP), Service Rate (Kbps), Low Drop Precedence (%full) xx=01, Med. Drop Precedence (%full) xx=10, and High Drop Precedence (%full) xx=11. It lists various Class Selectors and Assured Forwarding classes.

Figure H-5. Configuration | WAN | QoS Page (Control Mode = DiffServ)

### H.2.2.4.1 DiffServ Operational Examples

**Figure H-5** shows the DiffServ QoS Rule Table. During congestion, the QoS engine first services the prioritized Class Selector 1 through 7 queues (see the “**Priority**” and “**Per-Hop Behavior (PHB)**” columns); any remaining capacity is then "shared" among the Assured Forwarding Classes 1 through 4 (AF 1-4) and the Default class.

The **Service Rate** is the minimum rate, in kbps, that the QoS engine attempts to provide the AF class if the capacity exists during congestion. It is similar to a CIR but it is not absolute and it is NOT guaranteed over the Priority 1 through 7 classes.

If there is no congestion, there is no maximum limit on the AF class. However, during congestion, an AF class with Service Rate of "0" may experience near 100% discard or very high levels of discard as compared with other AF Classes with greater Service Rates. The QoS engine will not attempt to maintain a minimum rate for that class; however, Assured Forwarding algorithms may not cut that class off completely.

AF dropping is NOT controlled by data rate, but by the status of the system buffer. Any time there is "buffering" of the data, there is risk of AF traffic dropping. The maximum data rate without dropping is always the size of the capacity of the link (minus the demand of Classes 1 through 7).

There is NO maximum data rate for the AF Class except for the total capacity rate, regardless of the configured "service rate" or buffer settings. These values are significant ONLY when there is enough WAN congestion to force the system to start buffering data.

**For example:**

If the Service Rate for Assured Forwarding Class 3 is 500 kbps, what is the maximum data rate permitted – without dropping – for Low, Medium and High Drop Precedence if the Service Rate we have is 100 kbps, 90 kbps, or 80 kbps?

First, consider this common configuration:

- AF4 Service Rate 500 kbps Drop Precedence: Low=100% Med=75% High=50%
- AF3 Service Rate 500 kbps Drop Precedence: Low=100% Med=75% High=50%
- WAN Capacity = 7000 kbps
- AF4 traffic = 3000 kbps demanded                      3000 kbps passed
- AF3 traffic = 3000 kbps demanded                      3000 kbps passed

Here, because the total traffic is less than the WAN capacity, there is no dropping regardless of the Service Rate or Drop Precedence percentage. The low Service Rates have no impact at all on the data rate that is passed.

Next, using the same configuration parameters, consider the following:

- WAN Capacity = 7000 kbps
- Class 6 traffic = 5000 kbps demanded    5000 kbps passed

- AF4 traffic = 2000 kbps demanded      1000 kbps passed      50% of packets dropped
- AF3 traffic = 2000 kbps demanded      1000 kbps passed      50% of packets dropped

Now, congestion exists because the total traffic demanded is 9 Mbps while the defined capacity is only 7000 kbps (7 Mbps). At this point, the system starts buffering data. Once the buffer reaches 50% full, it starts Weighted Random Early Detection (WRED) drops of the AF classes.

Because both AF classes have Service rates of 500k and have the same priority, the system tries to give each class a minimum of 500k of data and distributes the extra capacity evenly between the two AF classes. Thus, in this example, each AF class gets 1000 kbps.

Here, you can see how AF3 Service rate is respected, similar to the behavior of a CIR. AF3's traffic has some level of "Assured Forwarding" – in this way, AF4 cannot fully starve AF3.

**QUESTION: What is the traffic value that can cause dropping for your current settings?**

**ANSWER:**

- Only WAN congestion determines IF AF dropping occurs – i.e., when WAN capacity is exceeded long enough to fill the system buffer by 50% (or as configured in the **High Drop Precedence (% Full)** setting).
- Service Rate does NOT determine if drops occur. It affects the "weighting" of discards among the AF classes. If traffic for only one AF class exists, then service rate effectively does nothing at all.
- The **Drop Precedence (% Full)** settings do NOT impact the occurrence of drops:
  - *Decreasing the **Drop Precedence (% Full)** values cause drops to occur faster *only after congestion occurs.**
  - *Increasing the **Drop Precedence (% Full)** values delay drops – dropping *waits* until the buffer is *fuller.**
  - The **Drop Precedence (% Full)** parameters have two effects:
    1. The **Drop Precedence (% Full)** parameters impact the weighting of drops within a given class. If all AF traffic arrives with the same Drop Precedence values, then these values have no impact. However, if AF class traffic comes in with different Drop Precedence values, then the **High Drop Precedence (% Full)** traffic is more likely to be discarded.
    2. Lower values will attempt to distribute drops more evenly as the excess data comes in. For *very lightly* congested links, this may help preserve continuity and minimize the impact of the drops. For *barely* congested links, higher setting values may reduce the total numbers of drops but increase buffering delays; these higher values also cause drops that are more dramatic when they do occur.

Which parameter effect is better for your particular traffic? Sudden severe drops are resultant with **High Drop Precedence (% Full)** values, while more gradual distributed drops result with **Low Drop Precedence (% Full)** values. Experience indicates that congestion rarely exists in just the right "sweet spot" for this to become a significant question.

Under heavy congestion, the impact of changing these settings is minimal. Under severe/sustained congestion, you will get the large discards regardless. The Service Rates can help to "weight" the priority between AF classes under these congestion states.

---

### H.3 QoS Congestion Avoidance

The QoS system supports Weighted Random Early Detection (WRED) based congestion avoidance. WRED can be enabled or disabled on any queue. When WRED is disabled, upon overdriving the queue the packets will be tail-dropped.

**For example, using the ODM-840 HTTP Interface 'Configuration | WAN | QoS' page:**

1. Select the DiffServ QoS Group Control Mode.
2. Set the modem Tx bandwidth to 10000 kbps.
3. The data rate of the modem drops down from 10000 kbps to 8700 kbps due to Es/No and ACM MODCOD adjustment.
4. The input data streams to the modem are the same as those used in the Min/Max QoS example provided in **Sect. H.2.2.2**.

**QUESTION: What is the total output data rate and what are the individual port output data rates?**

**ANSWER:**

- The QoS system first drains Priority 1 traffic. Since the management data stream is only 200 kbps, after serving Priority 1 traffic, QoS still has 9800 kbps ( $10000 - 200 = 9800$ ).
- QoS next drains Priority 2's 800 kbps traffic. After the end of the Priority 2 traffic, QoS still has 9000 kbps traffic available ( $9800 - 800 = 9000$ ).
- Similarly, QoS walks through all priorities until it hits the ASFD classes:
  - The beginning of ASFD Classes QoS leftover bandwidth is 2000 kbps.
  - All ASFD classes have the same Priority of 7, with different service rates.
  - ASFD service rate is a Committed Information Rate (CIR), except serviced if bandwidth available after serving all high priority queues. In this case, 2000 kbps bandwidth is



available, serving all service rates first. The total of all ASFD service rates are 1600 kbps, which is less than the 2 Mbps leftover bandwidth.

- After serving the service rates, the leftover bandwidth is 400 kbps. This 400 kbps will be distributed to all ASFD classes equally in Round-robin fashion until either there is no more bandwidth, or the input streams have no data.
- The resulting individual data rates are as follows:

Stream	Priority	PHB / DSCP Code	Service Rate	Drop Precedence	Data Rate
Management	1	CS7 / b111000	200 kbps	9800 kbps	200 kbps
Networking Control	2	CS6 / b110000	800 kbps	9000 kbps	800 kbps
Voice	3	EXFD / b101110	1000 kbps	8000 kbps	1000 kbps
Video	3	CS5 / b101000	4000 kbps	4000 kbps	4000 kbps
Data-1	4	CS4 / b100000	550 kbps	3450 kbps	550 kbps
Data-2	5	CS3 / b011000	1450 kbps	2000 kbps	1450 kbps
Data-3	7	ASFD4 / b100010	1000 kbps	N/A	100 + 100 kbps
Data-4	7	ASFD3 / b011010	1000 kbps	N/A	400 + 100 kbps
Data-5	7	ASFD2 / b010010	1000 kbps	N/A	500 + 100 kbps
Data-6	7	ASFD1 / b001010	1000 kbps	N/A	800 + 100 kbps
Data-7	8	BE / bXXXXXX	2000 kbps	N/A	0 kbps
<b>Total ▶</b>			<b>14000 kbps</b>	<b>0 kbps</b>	<b>10000 kbps</b>

---

## H.4 QoS with ACM/VCM (Adaptive/Variable Coding and Modulation)

When ACM is enabled, the modem is configured with symbol rate, while QoS operates on data rate. Although the symbol rate will be constant in ACM/VCM mode, the data rate will *not* be constant. As a result, the modem's data rate can vary "on-the-fly" based on the Es/No. The data rate can be more or less than when QoS was first configured, or when the modems first boots.

### H.4.1 Maximum Clipping

Due to ACM, when in QoS Max/Pri mode and the data rate's available bandwidth exceeds the maximum clipping rate, the QoS system limits the output rate of that rule to configured maximum clipping rate.

When the available data rate is less than the maximum clipping rate, the QoS system has nothing to clip, since it has not exceeded the defined maximum bandwidth rate.

### H.4.2 Minimum Data Rate

Due to ACM, when the data rate's available bandwidth exceeds the minimum data rate (per QoS Min/Max and DiffServ modes' ASFD classes), the QoS system operates as normal; since the minimum has been met, the available bandwidth is shared among all other same priorities in Round-robin fashion.

When the available data rate is less than the minimum data rate, then the QoS system shares equally among all same priority queues in a Round-robin fashion until either minimum bandwidth is met, or no more data is available to drain.

**For example, using the ODM-840 HTTP Interface:**

1. Select the DiffServ QoS Group Control Mode.
2. Enable ACM.
3. The data rate of the modem drops down from 10000 kbps to 8700 kbps due to Es/No.
4. Input data streams are the same as with the QoS Group Min/Max Mode example (see **Sect. H.2.2.2**).

**QUESTION: What will be the total data rate and what will be the individual data rates?**

**ANSWER:**

- After serving all high priority queues, only 500 kbps is left for ASFD classes.
- This leftover bandwidth is less than the total minimum bandwidth; it must therefore share the residual 500 kbps among all four ASFD classes equally – i.e.,  $500 / 4 = 125$  kbps per class.

- Since ASFD 4 has the service rate 100 kbps, the excess 75 kbps will be given the other queues where the service rate not met.
- In this case, the 75 kbps again will share equally among ASFD3, ASFD2, and ASFD1 since these service rates were not met.
- The resulting individual data rate is as follows:

Stream	Priority	PHB / DSCP Code	Input Data Rate (kbps)	Leftover BW After Serving the Queue (kbps)	QoS Output Data Rate (kbps)
Management	1	CS7 / b111000	200	9800	200
Networking Control	2	CS6 / b110000	800	9000	800
Voice	3	EXFD / b101110	1000	8000	1000
Video	3	CS5 / b101000	4000	4000	4000
Data-1	4	CS4 / b100000	550	3450	550
Data-2	5	CS3 / b011000	1450	2000	1450
Data-3	7	ASFD4 / b100010	1000	N/A	100
Data-4	7	ASFD3 / b011010	1000	N/A	175 + 25
Data-5	7	ASFD2 / b010010	1000	N/A	175 + 25
Data-6	7	ASFD1 / b001010	1000	N/A	175 + 25
Data-7	8	BE / bXXXXXX	2000	N/A	0
<b>Total ▶</b>			<b>14000</b>	<b>0</b>	<b>8700</b>

### H.4.3 Highly Degraded Remote

In the ACM/VCM Outbound channel, when a remote either highly degrades or loses communication, prior to FW Ver. 1.6.2.X the ACM/VCM controller in the CTOG-250 would assign a low MODCOD for traffic destined to a given remote, and attempt to honor any configured CIR. As a result, the number of symbols used to meet CIR for that degraded remote was disproportionate and resulted in a network-wide reduction in throughput.

The Highly Degraded Remote feature allows you to specify a “CIR Threshold MODCOD” on each ODM-840 that is automatically communicated to the CTOG-250. If the remote fades below this MODCOD and the Outbound link is fully utilized, the CTOG-250 will no longer try to maintain the CIR for traffic destined to that remote. Rather, the ACM/VCM QoS system will attempt to maintain a “fair share” of symbols for a highly degraded remote based upon the nominal number of symbols assigned to each QoS Group and its configured CIR.

The data rate at which a remote is clamped will scale as the remote degrades below the “CIR Threshold MODCOD” – i.e., the more it fades, the more the data rate is clamped.

Use the ODM-840 HTTP Interface ‘**Configuration | WAN | Demod | ACM**’ page to configure the “CIR Threshold MODCOD.” You can use the CTOG-250 HTTP Interface ‘**Configuration | WAN | Remotes Sites | Configuration**’ page to view the currently configured value.

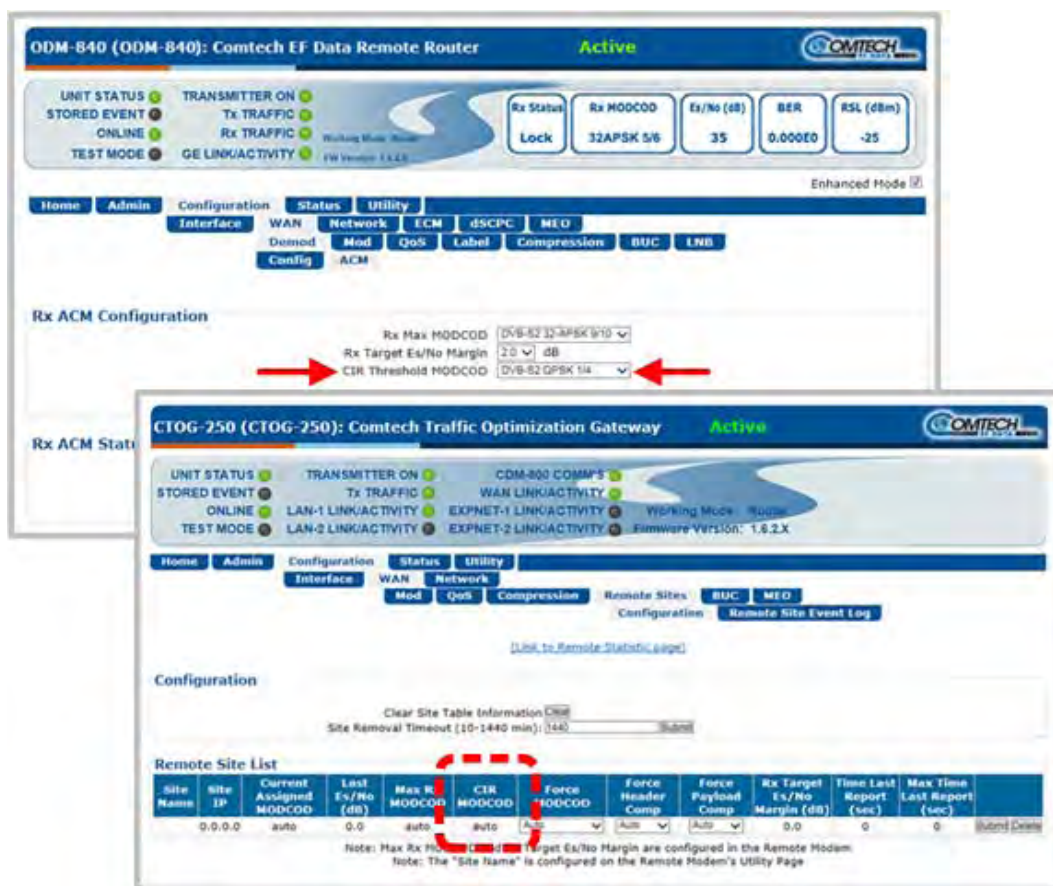

Figure H-6. Highly Degraded Remote Function – ODM-840 and CTOG-250 HTTP Interfaces

## H.5 QoS Statistics Reporting

The system collects extensive statistics that you can use to monitor performance in real time, or store for historical analysis. Use the ODM-840 HTTP Interface 'Status | Statistics | QoS' page (Figure H-7) to view this information.

(Link to QoS Configuration page)

**Statistics Control**

**Total For All Groups**

Tx Packets	Dropped Packets	Tx Packets Rate (pps)	Tx Data Rate (kbps)
0	0	0	0

**Group Table**

Index	Name	Data Rate (kbps)	Dropped Packets	Config. CIR (kbps)	Config. MIR (kbps)	CIR Avail Last 1 Min	CIR Avail Last 15 Min	CIR Avail Last 60 Min	Mode	Select
1	Default Group	0	0	0	160000	100%	100%	100%	Off	<input checked="" type="radio"/>

**QoS Statistics**

Index	Description	Tx Packets	Dropped Packets	Tx Packet Rate (packets/s)	Tx Data Rate (kbps)
1	Default	0	0	0	0
<b>Per Group Total</b>		0	0	0	0

**QoS Statistics**

Priority	Description	Tx Packets	Dropped Packets	Tx Packet Rate (packets/s)	Tx Data Rate (kbps)
1	Class Select 7	0	0	0	0
2	Class Select 6	0	0	0	0
3	Exped Forward	0	0	0	0
3	Class Select 5	0	0	0	0
4	Class Select 4	0	0	0	0
5	Class Select 3	0	0	0	0
6	Class Select 2	0	0	0	0
7	Class Select 1	0	0	0	0
8	Assured Fwd 4	0	0	0	0
8	Assured Fwd 3	0	0	0	0
8	Assured Fwd 2	0	0	0	0
8	Assured Fwd 1	0	0	0	0
9	Default DSCP	0	0	0	0
<b>Per Group Total</b>		0	0	0	0

(TOP) Page with QoS Control Mode = OFF, Max/Pri, Min/Max, or Pri-Weighted  
 (BOTTOM) QoS Statistics Section with QoS Control Mode = DiffServ

Figure H-7. ODM-840 HTTP Interface – Status | Statistics | QoS Page Examples

This page, depending on the active Control Mode, displays the following information:

- **Entire Return Statistics (updated every second with live data):**
  - Current Throughput (kbps)
  - Total Capacity (kbps)
  - Average bits/symbols per second
  - Unused Capacity (kbps)
  - Symbols per second Utilization (%)
  
- **QoS Group Statistics (updated every second):**
  - Totals for all QoS Groups sharing the return
  - CIR Availability (%):
    - Last 1 minute, 15 minutes, 60 minutes
    - % of time for the last 1 minute, 15 minutes, 60 minutes that CIR was available when requested.
  - Current aggregate data rate for each QoS Group
  
- **Per Rule Statistics (updated every second):**
  - Rule Name
  - Tx Packets per Rule
  - Dropped Packets per Rule
  - Tx Packet Rate (packets/second)
  - Tx Data Rate (kbps)
  - Totals for all Rules per Group

# Appendix J. ODM-840 RAN/WAN OPTIMIZATION



**UNLESS OTHERWISE NOTED – This appendix collectively refers to the Comtech EF Data Advanced VSAT Series ODM-840 Remote Router, ODMR-840 Reduced Form Factor Remote Router, and ODMR-840B Remote Router Board Set as the ODM-840.**

## J.1 Overview

The ODM-840 Remote Router supports E1 RAN (Radio Access Network) Optimization as a **FAST** option. This appendix provides detailed information about Comtech EF Data's patent pending RAN Optimization technology, which is designed to provide maximum savings while maintaining superior voice quality.

### J.1.1 Radio Access Network (RAN)

Figure J-1 illustrates typical 2G and 3G Radio Access Networks.

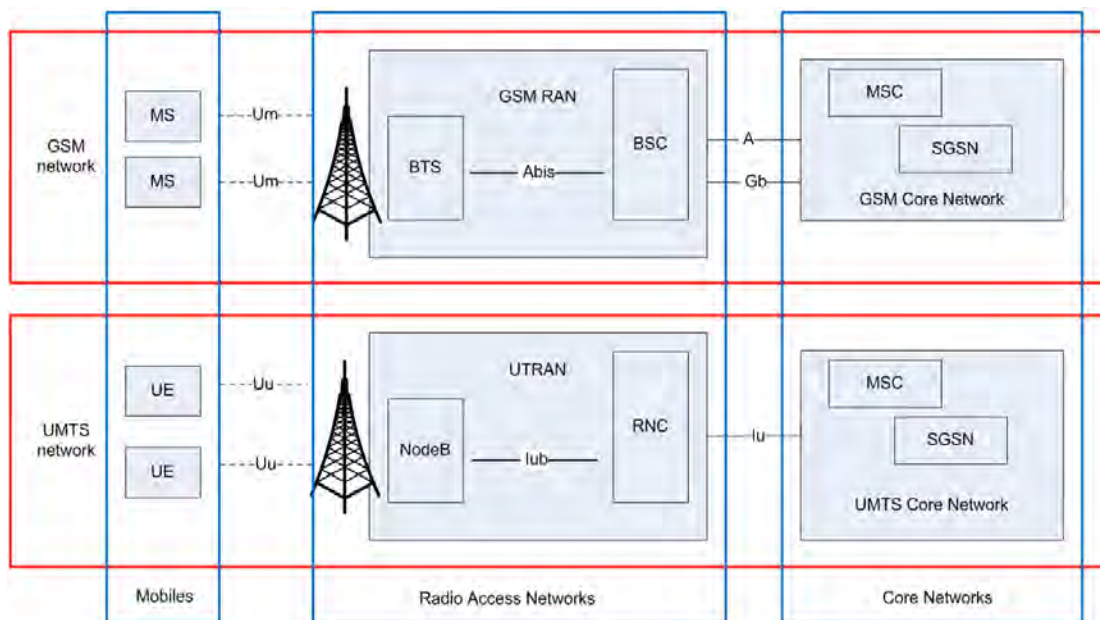

**Figure J-1. 2G / 3G Radio Access Network (RAN)**

In the cellular network, the RAN connects cell-site nodes with central-site nodes:

- For **Global System for Mobile Communications (GSM) / 2G**, the **Base Transceiver Stations (BTS)** connect to the **Base Station Controllers (BSC)** via the Abis interface. Voice, data and signaling are transported over one or more E1s.
- For **Universal Mobile Telecommunications Systems (UMTS) / 3G**, the **NodeB** connects to the **Radio Network Controller (RNC)** via the “hub” interface. Voice, data and signaling are transported over one or more E1s using **Asynchronous Transfer Mode (ATM)**.

### J.1.2 RAN Inefficiency

The 2G/3G RAN design is not efficient for satellite backhaul. For example, in the GSM Abis interface shown in **Figure J-2**, the resource allocation is on a fixed basis (one or more E1s per BTS), irrespective of the actual traffic. Within the E1, the **Time Slots (TS)** are dedicated to signaling, voice and data per Transceiver (TRX).

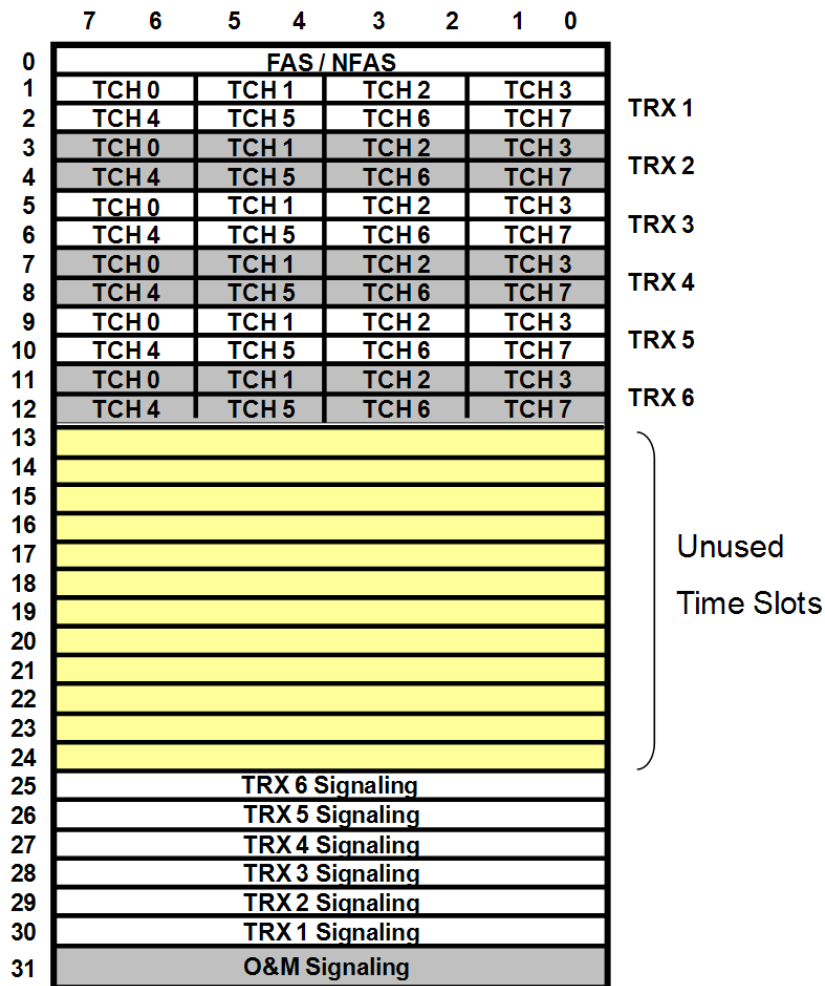

**Figure J-2. Typical Abis Map**



---

## J.2 E1 RAN Optimization



**E1 RAN Optimization is available only on the ODM-840 Remote Router. E1 operation is not available with the ODMR-840 Reduced Form Factor Remote Router or the ODMR-840B Remote Router Board Set.**

Jointly developed by Comtech EF Data, Comtech AHA Enterprise Products Group, and CEFD subsidiary Memotec Inc., RAN Optimization technology significantly reduces the **Wide Area Network (WAN)** / satellite bandwidth required to carry an E1 bearer used for cellular backhaul.

RAN Optimization allows the transmit modem data rate to be reduced relative to the input terrestrial data rate, thus allowing the transport of a user-selectable channel subset of bearer E1 using less bandwidth. In the receive direction, the data is restored to the E1 format for transport over the G.703 E1 interface.

The process is designed to allow varying levels of optimization to accommodate the incoming terrestrial data in the reduced modem data rate. Optimization performance depends on the traffic profile and the difference between the terrestrial data rate (based on input timeslot selection) and the transmit modem data rate. The optimization is performed in hardware for optimal performance.

The user has complete control over the desired level of optimization by selecting the time slots to be optimized, and the transmit modem data rate. Depending on the traffic profile, typical bandwidth reduction of 30-35% can be achieved with little or no impact to the voice quality.

Users have the option to reduce WAN bandwidth by as much as 60% relative to the ingress data rate – this allows the users to achieve desired bandwidth savings while maintaining desired voice quality.

## J.2.1 Process Overview

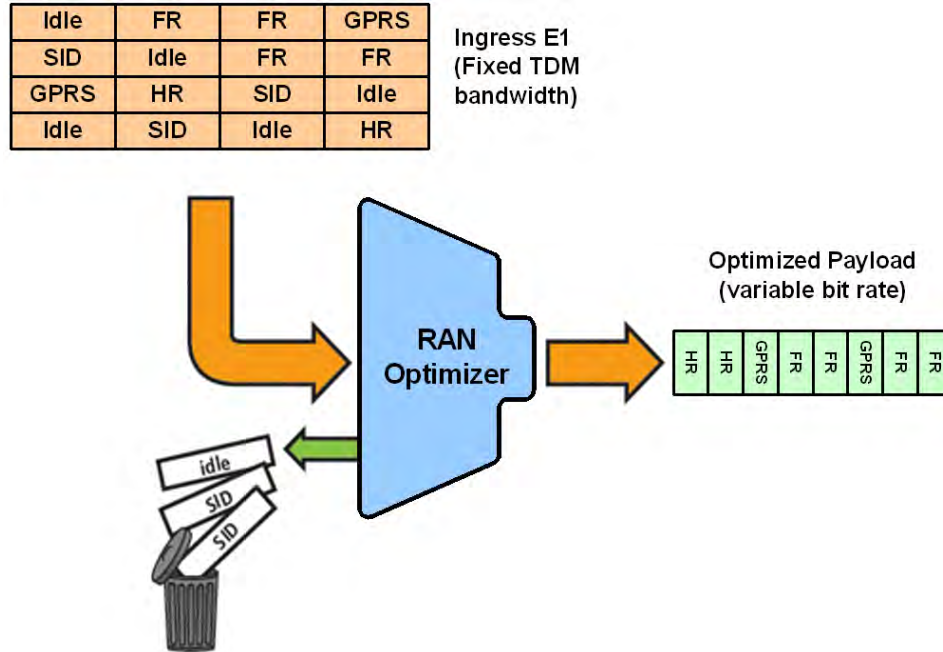

**Figure J-3. RAN Optimization (GSM Abis Interface)**

**On the transmit side**, the process for RAN Optimization is summarized as follows:

- The incoming 64 kbps Time Slots are de-multiplexed into Traffic Channels (TCH) ;
- TCH are inspected in real-time to identify Signaling, Voice, Data, and Idle;
- Idle TCH are removed;
- Silence frames are removed from the Voice channel;
- Signaling and Data TCH are compressed using lossless compression;
- O&M frames are compressed using lossless compression;
- Voice frames are compressed using lossless compression;
- Pre-emptive Bandwidth Management to maintain service quality;
- The optimized payload is sent to the modem for transmission.

**On the receive side**, this process is reversed, re-creating the E1 for transmission over the G.703 E1 interface.

## J.2.2 WAN Link Dimensioning and Pre-emptive Bandwidth Management

RAN traffic varies over time – variations during the day that peak at certain time(s), and longer term variation as user density/profile(s) changes. The WAN link can be dimensioned to accommodate the peak traffic, or it can be dimensioned to meet a statistically derived value (e.g. average traffic).

Dimensioning the WAN link for peak traffic may not be economically viable. However, dimensioning the WAN link for average traffic has its challenges. Specifically: What happens when the optimized traffic exceeds WAN capacity?

Typical of most other vendors' RAN optimization solutions, **Figure J-4** shows the optimized Abis traffic as a function of time, depending on the BTS traffic load. The red line is the pre-defined WAN link capacity (assuming 35% target optimization). Each time the optimized Abis traffic exceeds WAN capacity, packets are dropped and the voice quality degrades dramatically – even leading to dropped calls or in the worst case, causing BTS drop.

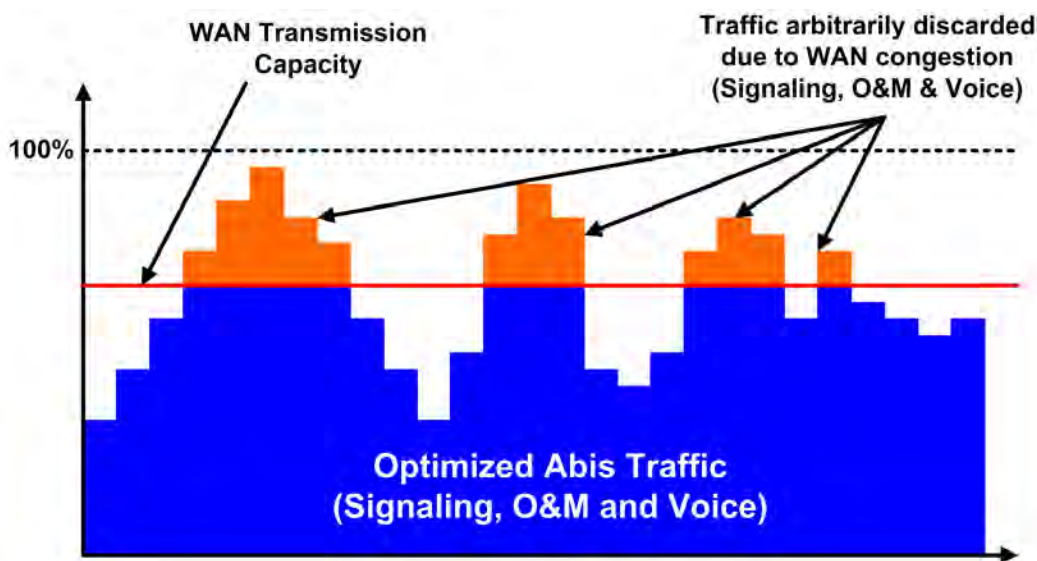

**Figure J-4. Optimized Abis Traffic *without* Pre-emptive BW Management**

The simplistic packet drop employed by most vendors in case of WAN congestion has potentially disastrous effects on voice quality and call handling – the results can include clicks, blank calls, and eventually call drops, especially if the BCCH channel of the TRX is impacted. In the worst case, it may even lead to BTS drop.

To compensate, most other vendor solutions are forced to over-dimension the WAN link, which leads to significant inefficiencies. *This methodology should not be acceptable to mobile operators.* A good RAN optimization solution should be nearly transparent, and should provide the same level of service to the mobile customers as when there is no RAN Optimization *while* providing a significant reduction in RAN transmission bandwidth.

As implemented by Comtech EF Data, the superior method of handling WAN congestion is to perform pre-emptive and selective voice packet discard. Comtech EF Data's RAN Optimization

solution employs a sophisticated bandwidth management capability to maintain *Service Quality*. The signaling and O&M traffic is always protected from being dropped in case of WAN congestion – this ensures that the BTS/NodeB stays connected and synchronized. The bandwidth manager smoothes peak traffic variation before the optimized RAN traffic reaches the available WAN capacity – this mechanism maintains good voice quality while effectively reaching the optimal target optimization rate.

Comtech EF Data’s patent pending algorithm on voice packet discard is designed to minimize the impact on the voice quality. This results in superior voice quality and improved *Service Quality* even at peak hour traffic load. Implementing a RAN optimization solution without such capability serves little purpose.

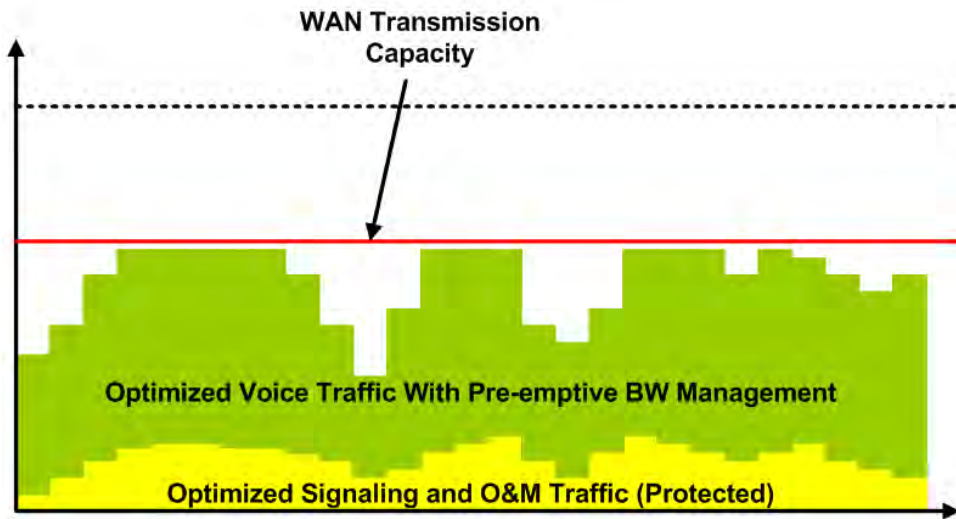

Figure J-5. Optimized Abis Traffic *with* Pre-emptive BW Management

---

## J.2.2.1 Performance Monitoring via the ODM-840 HTTP Interface



### Chapter 6. ETHERNET-BASED REMOTE PRODUCT MANAGEMENT



**YOU MAY PROCEED WITH ETHERNET-BASED REMOTE PRODUCT MANAGEMENT, ASSUMING THAT:**

- **YOU ARE OPERATING THE ODM-840 WITH THE LATEST VERSION FIRMWARE FILES.**
- **YOU HAVE CONNECTED THE ODM-840 TO A USER-SUPPLIED, WINDOWS-BASED PC AS FOLLOWS:**
  - **THE PC SERIAL PORT IS CONNECTED TO THE ODM-840 ‘CONSOLE/ REDUNDANCY’ PORT WITH A USER-SUPPLIED 19-PIN-TO-9-PIN ADAPTER SERIAL CABLE.**
  - **THE PC ETHERNET PORT IS CONNECTED TO THE ODM-840 ‘ETHERNET T/M’ ETHERNET PORT WITH A USER-SUPPLIED HUB, SWITCH, OR DIRECT WEATHERPROOF ETHERNET CABLE CONNECTION.**
  - **THE PC IS RUNNING A TERMINAL EMULATION PROGRAM (FOR OPERATION OF THE ODM-840 SERIAL INTERFACE) AND A COMPATIBLE WEB BROWSER (FOR OPERATION OF THE HTTP INTERFACE).**
- **YOU HAVE NOTED THE ODM-840 TRAFFIC/MANAGEMENT IP ADDRESS USING THE ODM-840 SERIAL INTERFACE.**
- **YOU HAVE PURCHASED AND ACTIVATED THE E1 RAN OPTIMIZATION FAST FEATURE.**

The RAN Optimizer collects detailed usage and performance statistics that are accessible from the ODM-840 HTTP Interface. **Figure J-6** shows the ODM-840 HTTP Interface “splash” page, and the menu tree for accessing this monitoring feature. Page functionality that is not specific to this operation appears dimmed.

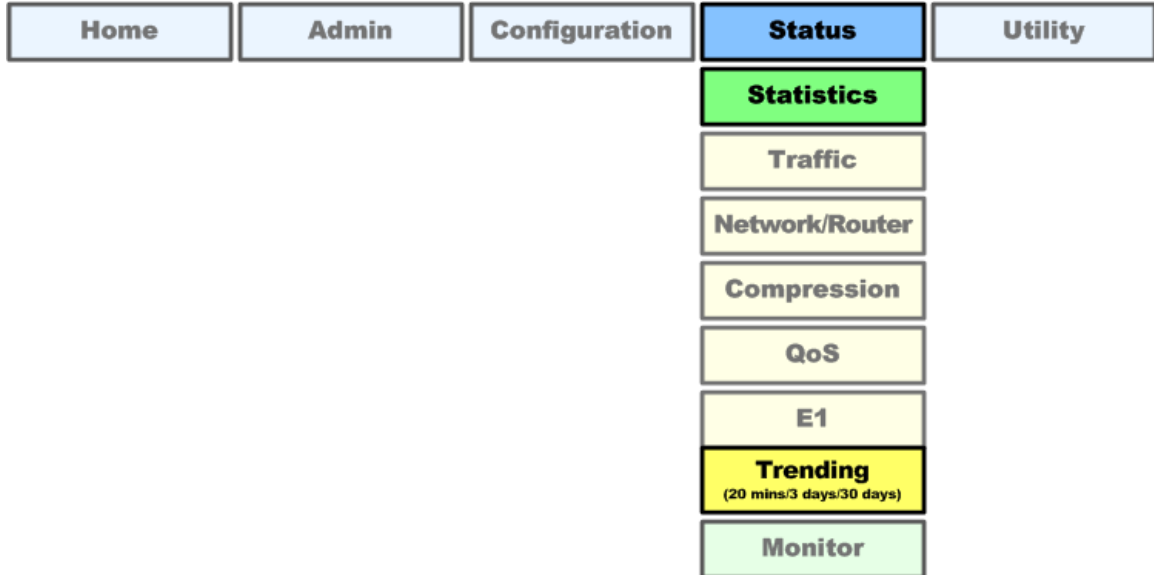
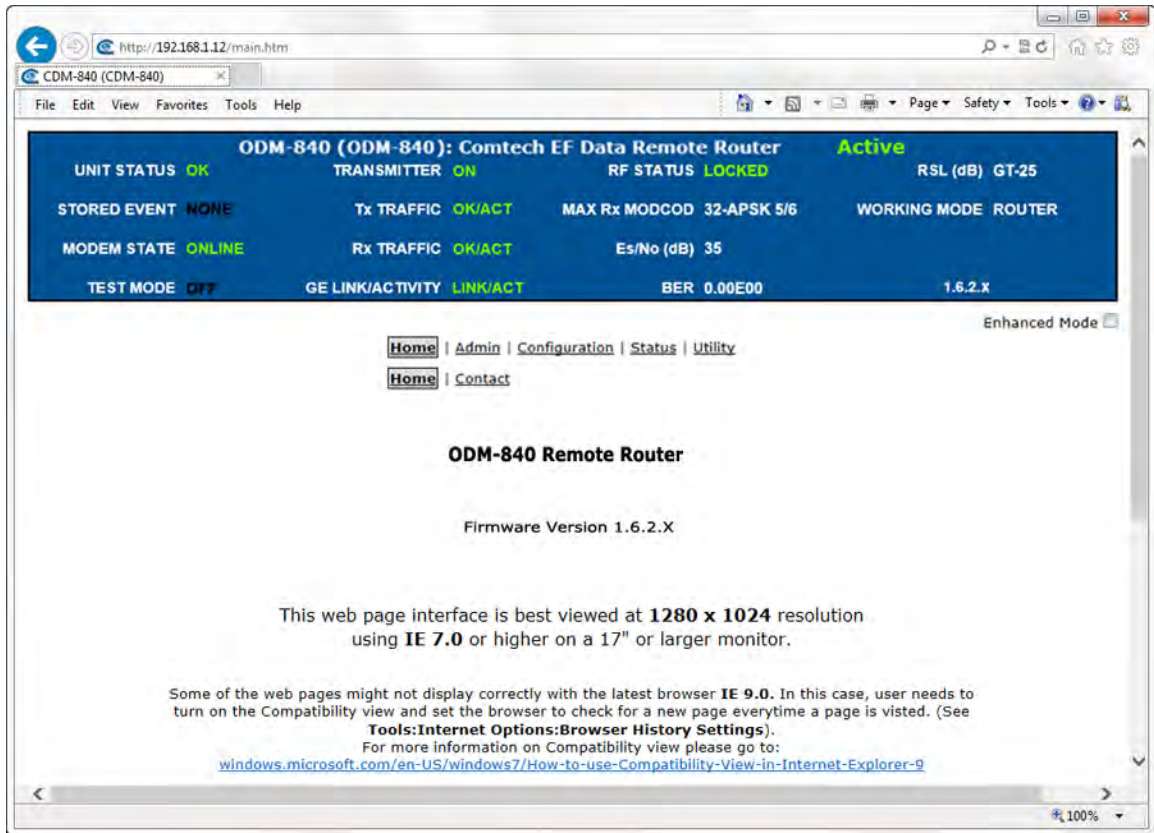

**Figure J-6. ODM-840 HTTP Interface and Menu Tree – Link Performance Monitoring (FW Ver. 1.6.2.X)**

Click the **Status**, **Statistics**, and **Trending** tabs to open the Trending (performance monitoring) page (**Figure J-7**). The graphs are viewable by selectable time spans. They display information needed to monitor the link performance and to take appropriate action as needed.

**To initialize the page:** Select the Time Span for the graphs as **20 minutes**, **3 Days**, or **30 Days**. Then, select **Auto Update** if you wish to set the trending data refresh interval from the default of **10 minutes** to **5 seconds**. Click **[Update]** to execute your selection. Allow a few seconds for the graphs to visually update.

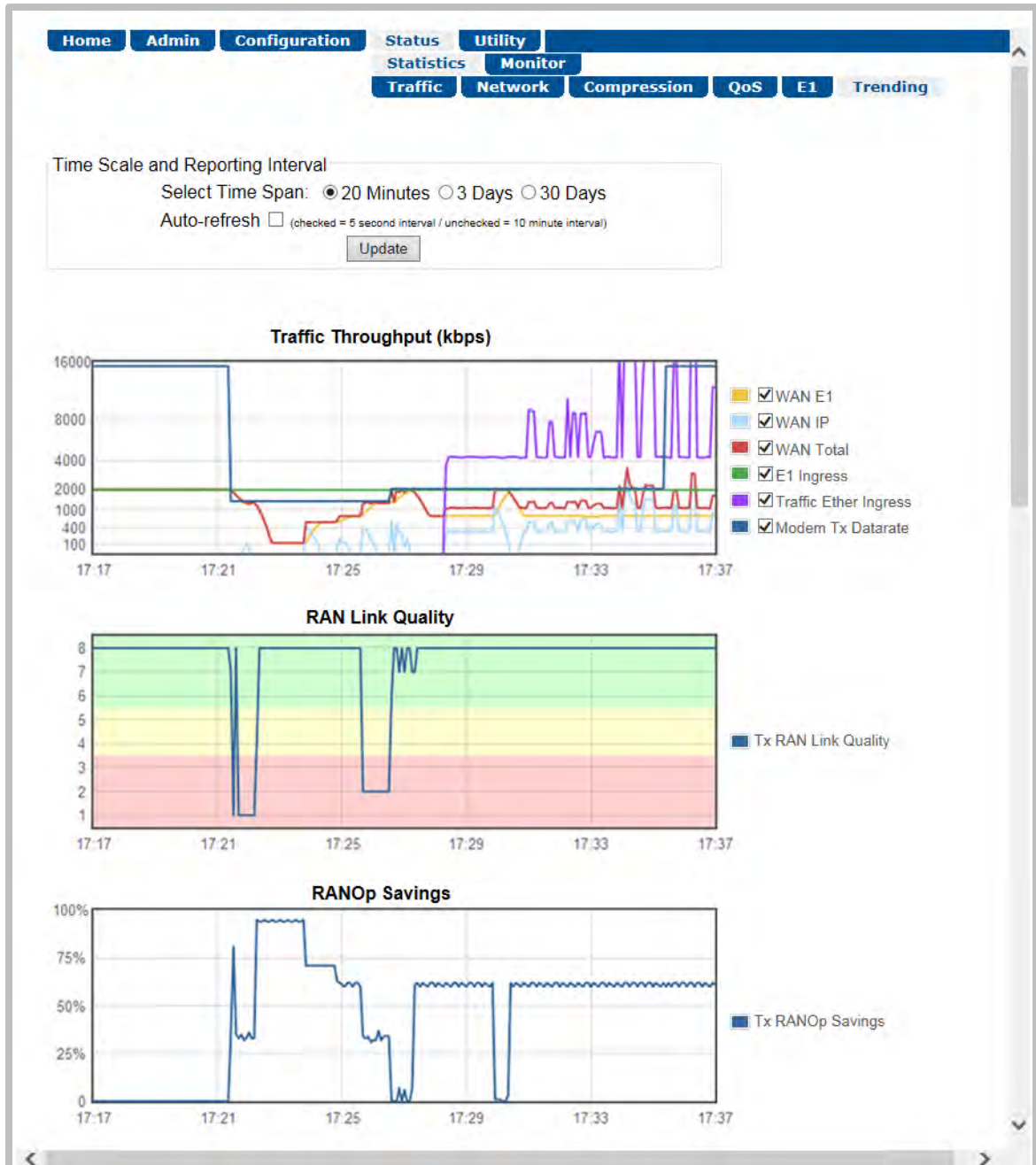
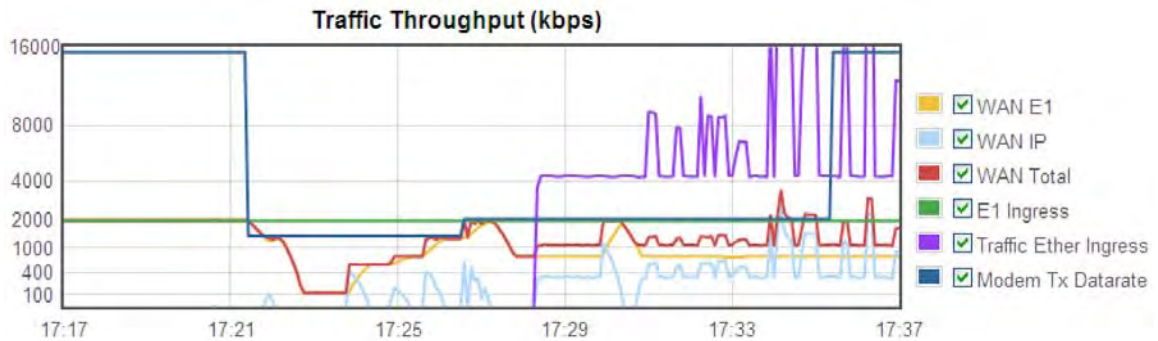

Figure J-7. ODM-840 HTTP Interface – Status | Statistics | Trending Page

### J.2.2.1.1 Traffic Throughput (kbps) Graph



This graph illustrates the utilization of all available data traffic types over the chosen time span. This example shows the graph with the 20-minute time span selected.

Note the following:

Type	Description
WAN E1	WAN data rate associated with E1/RAN traffic
WAN IP	WAN data rate associated with IP traffic
WAN Total	WAN data rate total (WAN E1 + WAN IP)
E1 Ingress	Data rate of E1 time slots carried (64K * number of time slots)
Traffic Ether Ingress	Data rate of Ethernet traffic
Modem Tx Datarate	Modem transmit data rate

### J.2.2.1.2 RAN Link Quality Graph

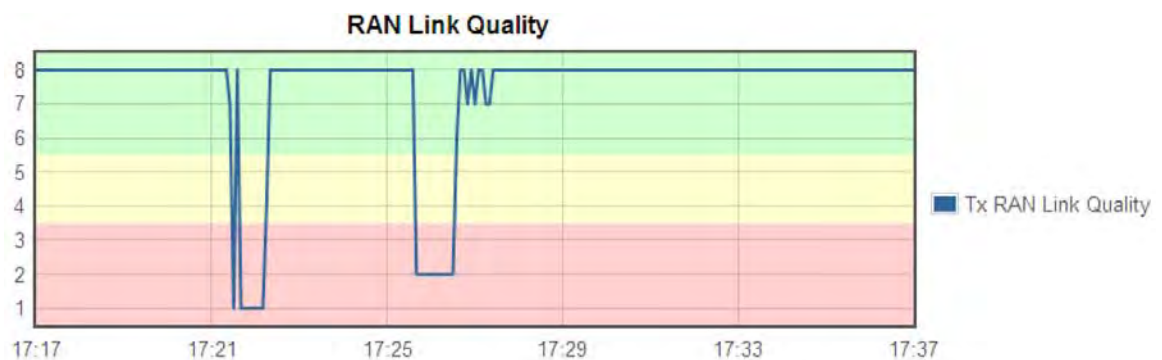

This graph illustrates the performance indicator for the Tx RAN Link Quality metric, a qualitative measure of the voice quality predicated by a) the level of compression, and b) voice packet discard required to accommodate the incoming traffic into the available WAN (satellite) bandwidth. This example shows the graph with the 20-minute time span selected.



Association of the Link Quality Metric to its comparative Link Quality is as follows:

Link Quality Metric	Link Quality
8	Excellent
7	Very Good
6	Good
5	Fair
4	Average
3	Poor
2	Very Poor
1	

Note that '8' on the graph indicates the highest quality, with no voice traffic discard.

### J.2.2.1.3 RANOp Savings Graph

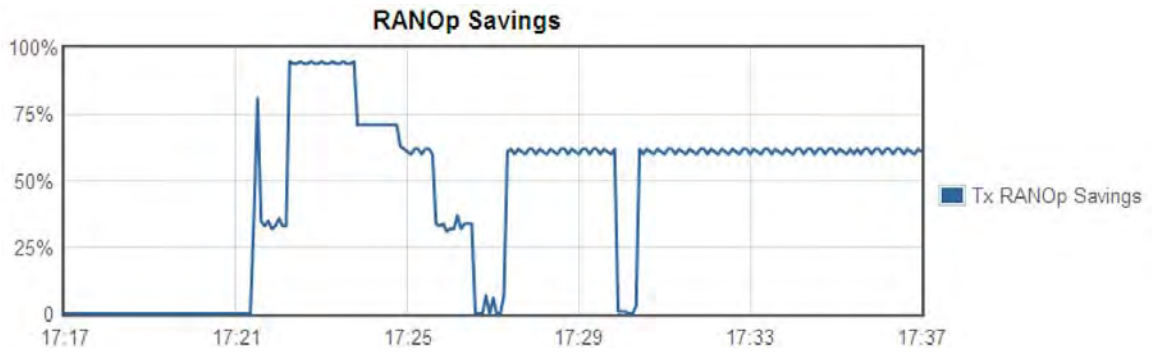

This graph illustrates the performance indicator for Tx RAN Optimization on an actual "percentage of savings" basis over the chosen time span. This example shows the graph with the 20-minute time span selected.



# Appendix K. dMESH (VMS DYNAMIC MESH) SOLUTIONS



**UNLESS OTHERWISE NOTED – This appendix collectively refers to the Comtech EF Data Advanced VSAT Series ODM-840 Remote Router, ODMR-840 Reduced Form Factor Remote Router, and ODMR-840B Remote Router Board Set as the ODM-840.**

---

## K.1 Overview



**VMS v3.x.x VIPERSAT Management System User Guide (CEFD P/N MN/22156)**

dMesh (Dynamic Mesh) connectivity minimizes the requirement for communications that are routed through a hub and re-routed back to the remote segments of an Advanced VSAT Network. The benefit of a dMesh circuit is that it reduces the time it takes to establish and maintain communications between remote sites. This eliminates double hop scenarios, provides less latency, and improves Quality of Service (QoS) between remote AVSAT locations; geostationary satellite single hop link latency is thereby maintained for real-time applications such as VoIP and videoconferencing. This is not a new concept – it has been implemented for many years in terrestrial microwave applications.

Although there are many satellite modem manufacturers producing new generations of products, few provide the means to address point-to-point or point-to-multipoint mesh connectivity or offer premium commercial-grade services between AVSAT locations. Mesh offerings are typically limited to TDM/TDMA and DAMA solutions, or “best-effort” service for circuit-switched voice as well as limited VoIP and data throughput.

Comtech EF Data leverages the concept of Bandwidth-on-Demand (BoD) by taking advantage of Dynamic Single Channel per Carrier (dSCPC) in a mesh environment and adapting it to Comtech EF Data’s Advanced VSAT Network platform. This adds dynamic point-to-multipoint SCPC mesh circuits to the network’s existing hub and remote link, and DVB-S2 outbound and VersaFEC dSCPC to the return link. Comtech EF Data manages these elements, and provides BoD in a mesh environment through its Vipersat Management System (VMS), the software switching engine behind our Vipersat technology.

## K.2 Operational Features

### K.2.1 Vipersat Management System

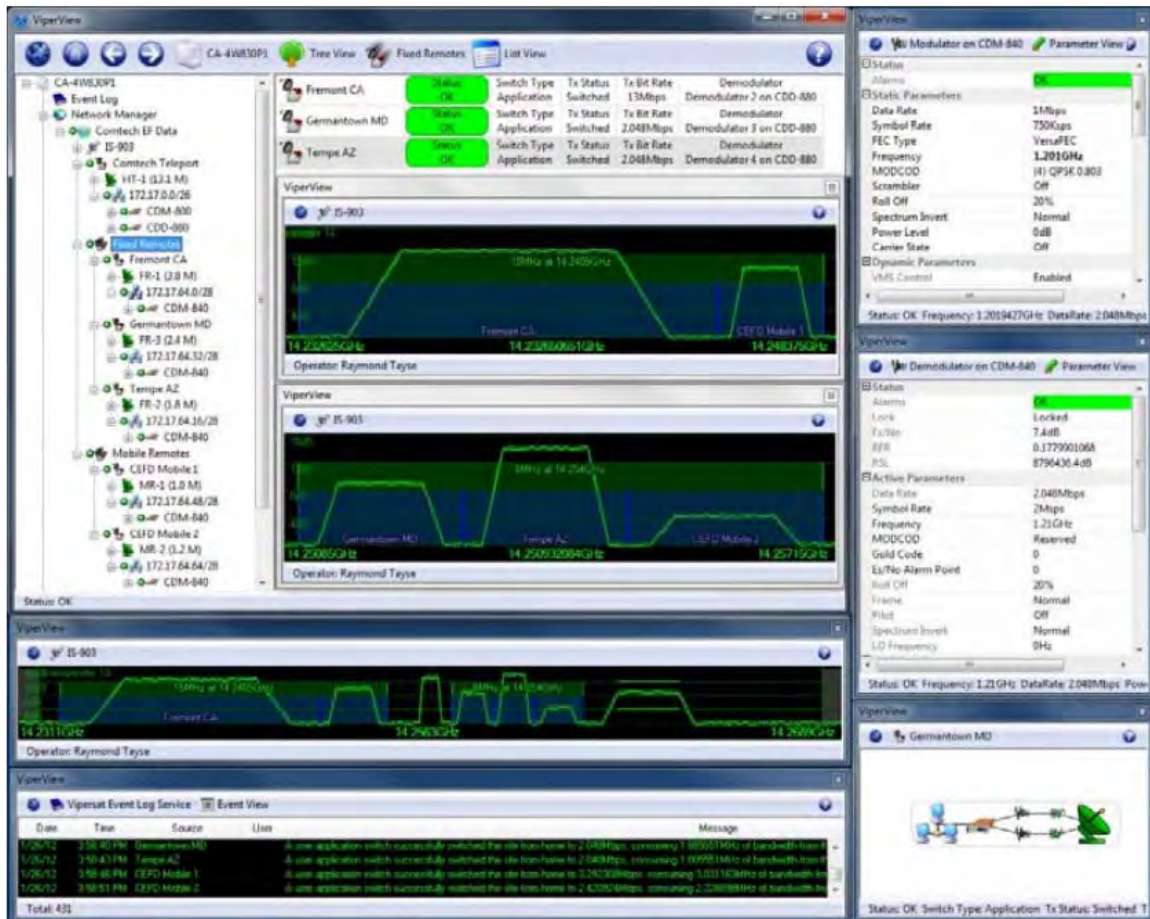

**Figure K-1. Vipersat Management System – Graphical User Interface (GUI)**

**Figure K-1** shows a typical VMS graphical user interface (GUI). The VMS GUI displays a graphical representation of the deployed modems and demodulators, remote subnets, RF carriers, and switching events.

**Figure K-2** shows typical deployment of a Comtech EF Data Advanced VSAT Network. The Advanced VSAT IP Network operates at Layer 3 in a routed mode of operation that supports dynamic mesh. A major advantage of the Vipersat technology is that its design encompasses the use of Comtech EF Data’s Advanced VSAT offerings (CTOG-250 Comtech Traffic Optimization Gateway w/CDM-800 Gateway Router and CDD-880 Multi Receiver Router at the hub site, and ODM-840 Remote Routers with CDD-880 Multi Receiver Routers at the remote sites).

For example, the Vipersat technology accommodates a mesh environment as follows:

- Similarly-equipped CDD-880s are used at the Vipersat-enabled hub and at the remote sites. The only differences between the network hub and remote site CDD-880s are the software interfaces and VMS configuration of the units. This intuitive design and configuration allows

for rapid deployment of units at the remote site and their addition to the VMS database at the hub site.

- The network provides a true single hop solution for point-to-point or point-to-multipoint connectivity between remote sites. VMS automatically sets up the circuits either by Type of Service (ToS) detection through the remote site ODM-840, or a Distribution List configured in the VMS server with the respective remote site policies.

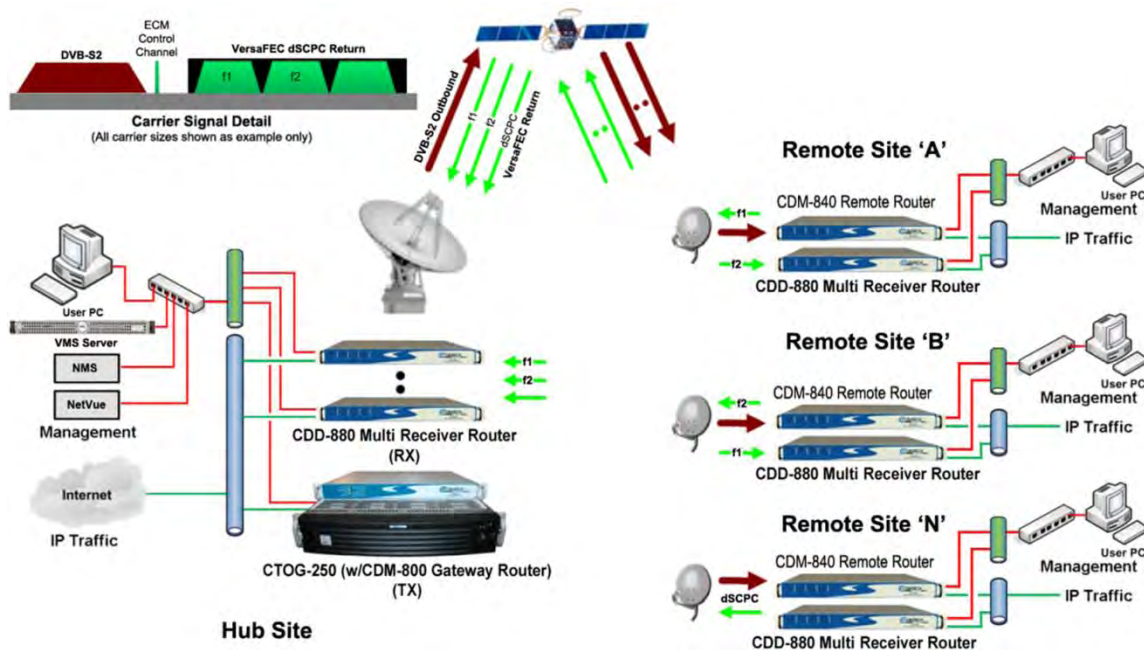

**Figure K-2. VMS-configured Advanced VSAT Network**

Startup of an application such as VoIP or videoconferencing initiates a switch request using ToS Detection. Upon ToS protocol detection, the ODM-840 forwards a switch request defined by network operator switching policy to VMS for the required bandwidth. VMS in turn, upon verification of available space segment and CDD-880 Expansion Demodulators, sends switching commands to the appropriate remote ODM-840 subnets, thus changing the ODM-840's Tx frequency/power level/data rate and ModCod, where applicable.

An available remote site CDD-880 is also tuned to receive the corresponding remote transmission, and a mesh circuit is created. As with Remote Sites 'A' and 'B', Remote Site 'N' is communicating with the Hub site via the CDD-880 Expansion Unit on another internal demodulator port. Since the CDD-880 Expansion Units at Remote Sites 'A' and 'B' also have a demodulator port tuned to their respective carrier, it is necessary to filter the traffic between them at the Hub site to avoid duplicate packets and unnecessary hub loading. This requires the entry of filter routes only at the hub's CDD-880 Expansion Unit. VMS automatically manages these routes – entering them when needed, and removing them when not.

From the VMS server interface, the Distribution List feature allows the operator to pre-define mesh circuits based on an Entry Channel Mode (ECM) switch, multicast transmission from remotes to a group of remotes, or the setup of monitor remotes. When the remote terminals

are powered on, their presence in the dSCPC distribution mesh is constant unless taken out by operator intervention.

## K.2.2 Return Link VersaFEC® ACM (Adaptive Coding and Modulation)

---

### K.2.2.1 VersaFEC®

The transmit (Tx) side of the ODM-840 uses a family of short-block LDPC codes called **VersaFEC®**. VersaFEC is a patent pending technology wholly owned and developed by Comtech EF Data and Comtech AHA Enterprise Products Group (the VersaFEC name is a trademark registered to Comtech AHA).

VersaFEC is ideal for lower data rates that demand the shortest possible latency. The VersaFEC codes are equally well-suited to Constant Coding and Modulation (CCM) applications.

### K.2.2.2 ACM (Adaptive Coding and Modulation)

---

ACM (Adaptive Coding and Modulation) in the ODM-840 is used in conjunction with VersaFEC and is currently for *IP traffic only*.

ACM is a technique that allows for automatic change in modulation and FEC Code Rate in response to changing link conditions. ACM may be used in packet-based satellite links to boost system throughput. The basic goal of ACM is to capture historically unused satellite system link margin and convert this margin into additional data throughput.

An ACM system is set up using a constant physical layer symbol rate – and therefore occupied bandwidth – and power, but with a varying assortment of modulation and coding combinations called *ModCods*. The ModCods are selected to span a range of  $E_s/N_0$  (Energy per Symbol to Noise density ratio) so that if a system detects a change in link margin – e.g., fading – it can use a different ModCod to preserve the link, albeit at a different user throughput rate. Therefore, in an ACM system, as  $E_s/N_0$  increases or decreases, so does the user data rate.

With ACM enabled, the ODM-840 offers significant operational enhancements:

- ACM maximizes throughput regardless of link conditions (noise, clear sky, rain fade, inclined orbit, antenna pointing error, or other impairments). Initial setup is easy and requires no further user intervention.
- ACM turns fade margin into increased link capacity – gains of 100% or more are possible, compared to traditional CCM. This is accomplished by automatically adapting the modulation type and FEC code rate to give highest possible throughput.

With a CCM system, severe rain fading can cause the total loss of the link – the result being zero throughput. ACM can keep the link active during heavy fades with lower throughput, and can yield much higher system availability.

The requirements for an ACM system that approaches the minimum possible latency are:

- The shortest possible LDPC codes that give performance at or very close to DVB-S2, in order to minimize latency, and which do not use interleaving.
- Design of the encoder to further reduce latency to the minimum possible.
- A constant number of symbols per block, to reduce the demodulator and decoder complexity, and significantly also reduces latency in the ACM case.
- The elimination of the need for pilot symbols for carrier tracking at low SNR by substitution of other modulation techniques. This further reduces the complexity of the demodulator.
- A reduction in the number of ModCods to further reduce complexity.
- The inclusion, at the physical layer, of an overhead channel to permit the reporting of SNR metrics back to the originating end. Note that this does not have to be enabled or disabled – it is part of the fundamental frame structure of VersaFEC ACM, and has been taken into account in the code rate.

#### K.2.2.2.1 ACM and dMesh

Although ACM and mesh are independent of one another, ACM is supported in a mesh environment. Return link ACM for the remote ODM-840 to the hub CDD-880 link is modeled after the Comtech EF Data CDM-625 Advanced Satellite Modem's ACM approach and framing, while adapting control techniques to operate in a dynamic point-to-multipoint network that includes a mesh environment.

#### K.2.2.2.2 ACM and DPC (Dynamic Power Control)



##### Appendix M. DPC (VMS DYNAMIC POWER CONTROL)

The DPC (Dynamic Power Control) feature provided in Comtech EF Data's Advanced VSAT products provides a mechanism whereby remote satellite uplinks have their transmit power levels adjusted in order to optimize the receive signal quality as measured by the corresponding demodulator  $E_s/N_0$  (the ratio of energy per symbol to noise density).

DPC and ACM function independent of one another, whereby power is modified first or second in combination with ACM. Depending on conditions, DPC and ACM can be operated exclusively or in combination, sharing the same resources for checks and balances. When DPC and ACM are operating in combination, the ODM-840/CDM-850 receives the LQRM comparing value to current settings and depending on conditions adjusts power or modifies ModCod.

---

## K.3 Operational Example

### K.3.1 Requirements for Bandwidth-on-Demand and dMesh with SHOD (Single Hop on Demand)

For any dynamic switch to occur, you need to adhere to some minimum requirements:

- Your active network is an Advanced VSAT Network platform Version 1.5.2.1 or greater running a Vipersat Management System (e.g., VMS Version 3.12.x).
- Space segment in the shared dSCPC bandwidth pool must be available.
- CDD-880 Expansion Units must be available at the hub site and each AVSAT remote site.
  - The hub site and remote site must be equipped identically. You may populate each CDD-880 1RU chassis with up to 12 demodulators – two demodulators per card, up to six cards per unit. This provides a maximum of 12 point-to-multipoint dynamic mesh circuits between remote sites (assuming each remote site is equipped with a fully populated CDD-880).
  - If more circuits are needed, you simply add more CDD-880s at the AVSAT remote sites and at the hub location. (Again, the units at either side of the network must be populated equally with the appropriate number of demodulator cards.)

Such configurations allow transmission of a single carrier from an originating remote ODM-840, a benefit that results in requiring operation of a lower-wattage BUC and/or use of a smaller antenna, when compared with what would be required with multiple carriers transmitted from a remote site.



**You must make sure that the differential in receive gain between the hub antenna and remote mesh antennas does not exceed **TBD**.**

### K.3.2 dMesh Operation

Meshed links can be set up based on specific applications that are sent from one remote site to another remote site or group of remotes sites. The easiest way to demonstrate the meshing capability of a Vipersat-managed Advanced VSAT Network is by using Distribution Lists.

Distribution Lists allow you to set up a list of sites to be included in a switch under defined circumstances, such as meshing based on an ECM switch, multicast transmission from a remote to a group of remotes, or the setup of monitor remotes. This feature can be used to tune expansion demodulators at a list of sites for upstream switched services, to provide for point-to-multipoint distribution on an InBand service connection.



### K.3.2.1 Create a Distribution List



Chapter 3. VMS Configuration “Define Distribution Lists” in VMS v3.x.x VIPERSAT Management System User Guide (CEFD P/N MN/22156)

Use the VMS to set up a Distribution List. Do these steps:

1. From the VMS GUI, right click on a remote site icon to open the Properties page:

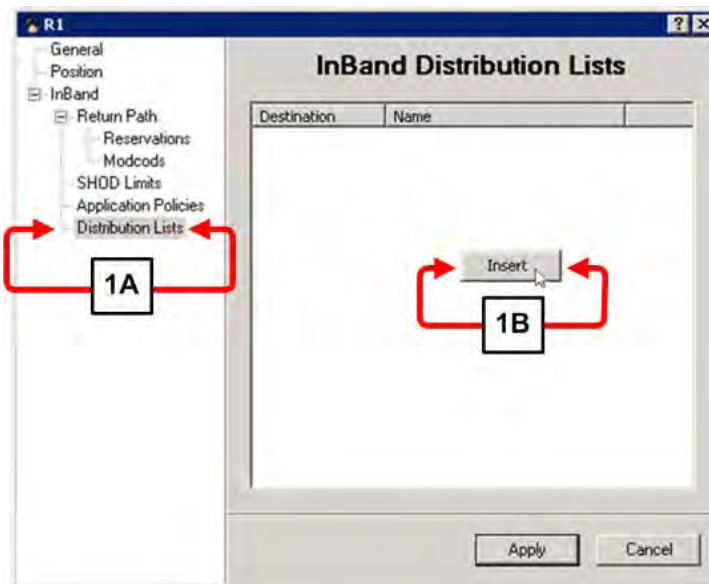

- a) Highlight the **Distribution Lists** tag.
  - b) Right-click in the white space below the **InBand Distribution Lists** label. Click the **[Insert]** button that appears. The **Distribute List** dialogue window appears.
2. If the distribution is intended for multiple remotes, you may use the **Distribute List** dialogue window to enter them:

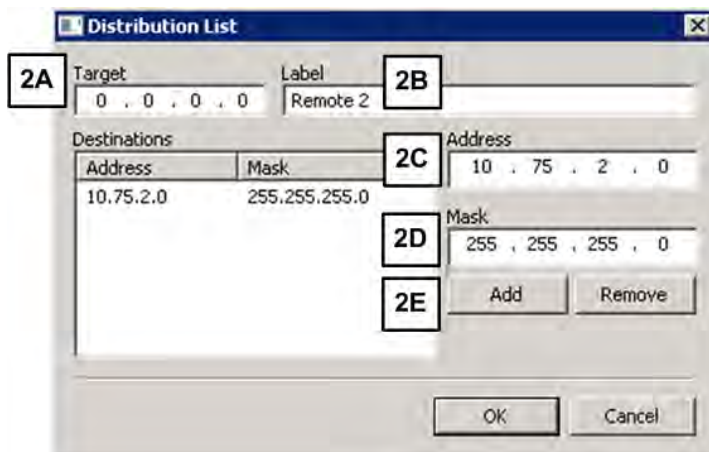

- a) The target box shows all zeros, which means that any packet destined to the subnets shown here causes the VMS to set up a mesh connection.
  - b) Enter a **Label** that is easy to remember, such as the name of the target remote (e.g., **Remote 2**).
  - c) Enter the network **Address** for the remote subnet.
  - d) Enter the subnet **Mask**.
  - e) Click [**Add**]. The network **Address** and subnet **Mask** appear in the **Destinations** window.
3. **Add CDD-880 Expansion Units to Antenna View.** To set up a mesh, the VMS must have available CDD-880 Expansion Units at the target remote site. Remote site mesh units must be dropped on the antenna and made available as shown here:

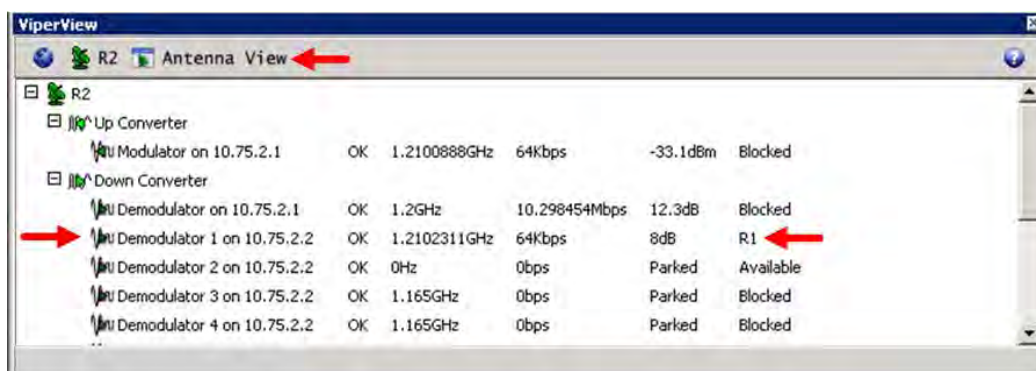

Note that this is the antenna view for R2 (Remote 2) and Demodulator #1 of this remote site's CDD-880 Expansion Unit is already involved in a mesh with R1 (Remote 1).

4. **Define your filtering rules.** The VMS dynamically enters filters at the Hub demodulator(s) when it sets up a mesh. It does this to prevent loops and duplicate packets on the network. Filters are also a function of the mesh location at the remote site. The CDD-880 HTTP Interface **Configuration | Network | Routing** page (Figure K-3) defaults the Mesh Location to **Hub**.



**To ensure proper operation and to prevent network loops, you MUST make sure that each remote site CDD-880 Expansion Unit has its Mesh Location set to Remote. The inset in Figure K-3 shows such a Mesh Location setting.**



**In CDD-880 Multi Receiver Router Installation Operation Manual (CEFD P/N MN-CDD880): See Sect. 6.3.3.3.1 Configuration | Network | Routing in Chapter 6. ETHERNET-BASED REMOTE PRODUCT MANAGEMENT for details about using this interface.**

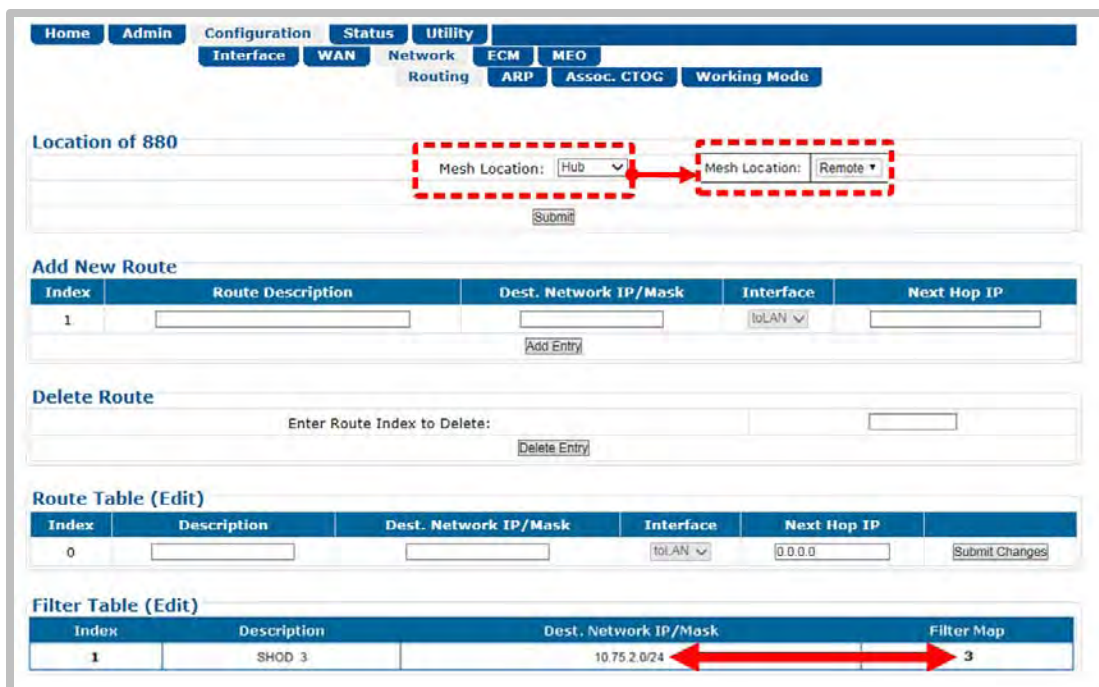

**Figure K-3. CDD-880 HTTP Interface – Configuration | Network | Routing Page**

For each individual mesh connection, the VMS enters a SHOD (Single Hop On Demand) at the Hub site CDD-880 demodulator as shown in **Figure K-3**. The **Filter Table** lists the **Destination Network IP/Mask** and a **Filter Map**. This **Filter Map** corresponds to the Hub site CDD-880 demodulator that is tuned to the remote site originating the mesh.

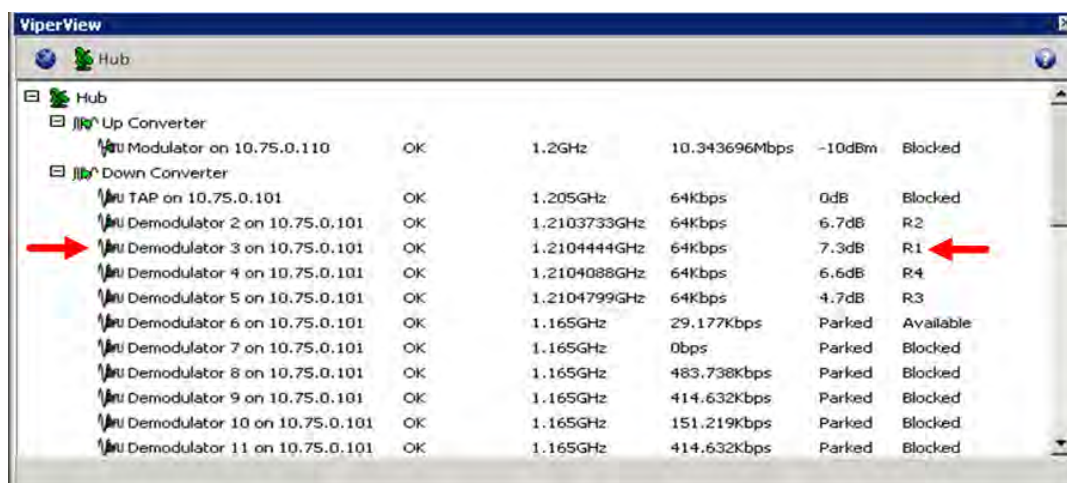

The intent of this filter rule is to block any packets originating from R1 that are destined to R2. This prevents traffic to the meshed remote site from going on to the Hub LAN and being retransmitted by the TDM (CTOG-250) outbound.

- Single Hop On Demand (SHOD):** The VMS adds an additional SHOD filter to the Hub CDD-880 for this subnet. If the traffic subnet is part of a subnet that can be described in one route statement (e.g., a subset of the same Class C that is the management subnet), this is

not necessary. However, any subnets that are past a router at the target remote must be entered as external subnets.

- 6. Mesh Setup Based on ToS Detection:** The detection by a ODM-840 Remote Router of a ToS stamped packet can provide the means for setting up a SHOD mesh connection from that remote to another remote within the network.



**For these SHOD connections, it is assumed that each remote site that is part of the SHOD connection has, at minimum, one CDD-880 Expansion Unit.**

When a Remote site ODM-840 detects a packet that has been stamped with a ToS value that matches the user defined value, the ODM-840 then sends a switch request to the VMS, requesting the user defined bandwidth. The switch request also contains the address that the ToS stamped packet was destined for.

The VMS processes the switch request and compares the destination address to the list of known subnets to determine if the destination belongs to another remote within the network. If the address does belong to another remote, the VMS will look for available hardware and bandwidth, and then issue tuning commands to set up the connection. Each direction of the mesh is set up independently; i.e., the detection that occurs at Remote 1 establishes a connection from Remote 1 to the other remote involved. However, the other remote must perform detection for set up in the opposite direction, thus creating a full duplex mesh connection.

## K.4 Compatibility

All Comtech EF Data products are designed to ensure seamless cohesion when interfacing its ODM-840s or demodulators to a single VMS Server. **Table K-1** lists the available Comtech EF Data products that are supported by Vipersat technology.

**Table K-1. Comtech EF Data Product Compatibility Reference**

Product	Max Data Rate (Mbps)	In-Band	Out-of-Band	Mesh	dSCPC Switching Methods							
					Scheduled	Manual	ToS	Load	QoS	VESP	Hitless	Advanced
CDM-570/CDM-570L	9.98	X	X	X	X	X	X	X	X	X	X	X
CDM-600/CDM-600L	20		X		X	X				X		X
CDM-625	25		X		X	X				X		X
CDM-750	169		X		X	X				X		X
CDM-800 (p/o CTOG-250)		X	X	X	X	X	X	X	X	X	X	X
CDM-840/ODM-840	15.35	X	X	X	X	X	X	X	X	X	X	X
SLM-5650A	155	X	X	X	X	X	X	X		X		X
CDD-562L	9.98	X	X	X	X	X	X	X	X	X	X	X
CDD-564/CDD-564L	9.98	X	X	X	X	X	X	X	X	X	X	X
CDD-880	15.35	X	X	X	X	X	X	X	X	X	X	X

## K.5 Summary

Vipersat provides a dynamic mesh for remote-to-remote communication through its use of a unique equipment topology and switching engine. It requires only a single transmitted SCPC carrier from each remote, as opposed to having multiple carriers at each site. Corresponding remote sites need available CDD-880 Multi-Receiver Router Expansion Units to receive the mesh transmission; this establishes a true dynamic SCPC circuit between remotes.

Hardware costs are also significantly lower due to the ability to deploy the CDD-880s at both the hub location and the remote sites. ACM maintains link connectivity by “down revving” the ModCods while maintaining a constant symbol rate and power level.



# Appendix L. DPC (VMS DYNAMIC POWER CONTROL)



**UNLESS OTHERWISE NOTED** – This appendix collectively refers to the Comtech EF Data Advanced VSAT Series CDM-840 Remote Router, ODM-840 Remote Router, ODMR-840 Reduced Form Factor Remote Router, and ODMR-840B Remote Router Board Set as the CDM-840 or the ODM-840.

---

## L.1 Overview



VMS v3.x.x VIPERSAT Management System User Guide (CEFD P/N MN/22156)



This appendix provides information on Dynamic Power Control in reference to the return path only – CDM-840 Remote Router to CDD-880 Multi Receiver Router control.

This appendix explains the design details, mechanisms, and functional operation of the DPC (Dynamic Power Control) feature provided in Comtech EF Data's Advanced VSAT products.

DPC provides a mechanism whereby remote satellite uplinks have their transmit power levels adjusted in order to optimize the receive signal quality as measured by the corresponding demodulator  $E_s/N_0$  (the ratio of energy per symbol to noise density). This optimization process acts to either increase or decrease transmitted signal levels in order to:

- Achieve a minimum level of received  $E_s/N_0$  consistent with providing an error free link or set margin.
- Reduce transmit power where sufficient link margin exists in order to optimize group station uplink saturation and/or satellite transponder power usage reducing costs.
- Increase link availability when margins apply (typically Ku-Band or Ka-Band).
- Maintain proper power backoff to eliminate high power amplifier saturation and carrier distortion.

DPC is a selectable software feature operating independently on CDM-840s exchanging a UDP message between the receiving unit (where the signal quality is being measured) and the

transmitting unit (where the power level is to be adjusted). This message contains link quality status, which is directed to the transmit site on timed intervals, updating the link state.

## L.1.1 Background

Satellite networks are subject to uplink/downlink degradations due to rain fade or other environmental factors. To ensure target link availability, network designers must take into account the rain region on both sides of a link, and design the terminals and operating point to include the appropriate link margins.

Satellite network operators typically lease Power Equivalent Bandwidth (PEB) from satellite owners. In clear sky operation, the terminals on both sides of the link transmit with RF power on the ground as a means to employ the PEB of the satellite that is assigned to that link. The presence of rain or other environmental attenuation lowers the RF power received at the satellite relative to clear sky conditions.

In principle, terminals with sufficient RF power could increase their transmit power during rain loss conditions, to compensate for the loss and maintain the PEB on the satellite. However, rain fade may occur at the uplink or downlink location, which presents an ambiguity for each transmitting modem. If power is controlled solely on receiving quality and not power-limited at the transmitter, the satellite PEB may be exceeded – oversubscribing service level agreements or, worse, resulting in adjacent carrier interference.

Such oversubscription is common in traditional uplink power control technology. Modems, in general, can automatically compensate for rain attenuation, but with power constraints and set limits not to exceed site margins. Running uplink power at margin, however, tends to flat-line power availability. If the modems are fed sufficient information to determine which side of the link is being impacted by rain fade, the power may exceed margin limits without compromising PEB, whereby the terminal knows the contribution of attenuation on the downlink and the remainder of uplink attenuation is between the transmitting terminal and the satellite. The additional information is obtained by monitoring the hub's outbound transmission and taking the clear sky quality reading as a zero reference, then disseminating the offset to all listening remotes.

---

## L.2 Theory of Operation

### L.2.1 About DPC

DPC is divided into two segments: return path remote to hub/forward path hub to remote.

On the return path, power adjustments can interoperate with Adaptive Coding and Modulation (ACM) by combining modulator output power adjustments with ACM step points. This exchange allows the transmit power level to try and compensate for fade before it is necessary to decrease data link capacity. The fade reporting adjustment is maintained by Adaptive Control Loop (ACL), which reports receiving  $E_s/N_0$  using messages over the LAN/WAN data transmission segments. The ACL continuously updates the link conditions for each active receiving demodulator.



The CDM-840 takes receipt of these messages via the outbound channel in order to take the appropriate actions. Thus, depending on the link estimation compared to internal power curves, the link is adaptive through configuration limits that maintain power budgets on the satellite.

## L.2.2 DPC Functionality

DPC can be applied to any or all of the CDM-840s with the exception of the Entry Channel Mode (ECM) control CDD-880s in Dynamic Single Carrier Per Channel (dSCPC) networks. Since the ECM burst CDD-880s are dSCPC fast acquisition receivers, they cannot provide accurate signal quality  $E_s/N_0$  measurements, which is critical in closing and maintaining a stable power control loop mechanism. The “Power Hunt” function is used in place of the closed loop control, and is described later in this appendix.

The CDM-840 receives each message and compares it to tables, automatically adjusting the uplink modulator transmit power to maintain a target signal-to-noise ratio (SNR) as measured by the downlink signal quality at the corresponding receive demodulator(s). This exchange provides a mechanism to compensate for varying signal levels during transmit uplink/downlink fade conditions.

The power control algorithm is a closed loop servomechanism linked to the received  $E_s/N_0$  value as the input function; the modulators transmit power attenuator as the output function. Only modulator transmit power is controlled by the algorithm, assuming that the transmit up-conversion chain (BUC) is a fixed gain block.

---

### L.2.2.1 Entrance Link Cabling

DPC relies on basic fundamental settings before it can operate properly. These parameters build the foundation on which the control can reference all power variations. One significant but often overlooked parameter is the transmit cable attenuation between the ODM-840 and the BUC.

The entrance link cable run can be problematic when trying to balance the modulator’s output signal level to the output gain power of the BUC. If the mismatch of balance is not calculated during site commissioning, this can result in:

- Too much cable attenuation and not enough power from the modulator to drive the BUC output to achieve required uplink power, or
- Not enough cable attenuation and the minimum output power of the modulator is still overdriving the BUC, or worse, PEB on the satellite.

To help manage this problem, DPC Power Reference calibration takes into consideration budgeted parameters, maximum data rate, and power margin to determine rated and/or terminal maximum power. The Power Reference function uses the budgeted values, calculating from current power determining the amount of power required to achieve maximum. If the calculated power exceeds the modulator’s maximum output power range, the cable run has too

much attenuation. This can possibly limit the terminal from reaching budgeted margin and/or terminal maximum power.

Power Reference calibration returns an error if the modulator output level is  $>0$  dBm. If this happens, you are notified to reevaluate budget values or cable attenuation before Power Reference power is complete. Although modulator minimum power (-40 dBm) is still important, it is not as critical to overall performance. The best balance for nominal operation is somewhere in the middle of the range, leaving headroom on the top and bottom. This range balance is extremely important when operating the network in dSCPC, as the system varies symbol rate and power.



For more information on ODM-840 commissioning and cabling considerations, see Comtech EF Data Quick Reference Document QR-CDM840.

## L.2.2.2 Operational Essentials

Three basic criteria apply to power control function: **Power Reference**, **Rated Maximum Power**, and **Terminal Maximum Power**. Each plays an important role in constraining and maintaining power adjustments on the fly, with range check parameters, Tx Power Margin, and Maximum Data Rate providing power constraints.

### L.2.2.2.1 Power Reference

Reference Calibration uses the listed operational essentials to take a unique approach in determining a power reference. This approach allows setting the reference at any point during dSCPC operation. However, to avoid the risk of improper entrance link balance, the operator **MUST** calibrate at the time of antenna commissioning.

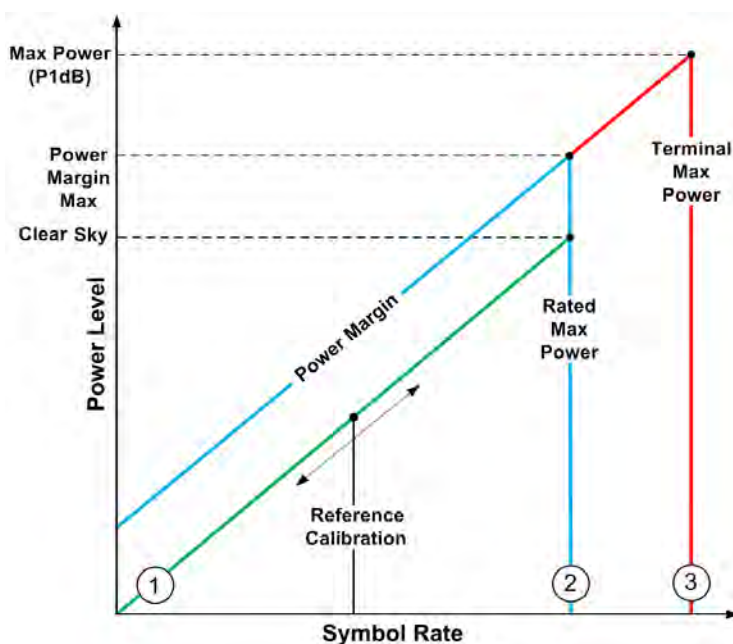

Figure L-1. DPC Power Scale

The DPC Power Scale (**Figure L-1**) represents the different calibration levels and limits depending on link-budgeted power parameters. When using the DPC Reference Calibration, the requirements that follow must be taken into consideration to determine link quality and the achievable maximum power.

#### L.2.2.2.2 Reference Calibration

Per **Figure L-1**: Line 1 (the green line) represents the calibration point which can be called anytime during dSCPC operation. Reference calibration uses current symbol rate and ModCod to target error-free link quality. Reference recalibration, during normal operation, forces re-evaluation, which could represent a different point on the scale, but not modifying maximum power set points.

#### L.2.2.2.3 Rated Maximum Power

Per **Figure L-1**: Line 2 (the blue line) indicates the breakpoint of rated maximum power given by the link budget parameters of maximum data rate, ModCod, and margin. This is the power adjustment between clear-sky and fade conditions and how much additional power is applied without exceeding assigned terminal PEB. *This assumes hub downlink fade or backoff condition is not set/unknown.*

#### L.2.2.2.4 Terminal Maximum Power

Per **Figure L-1**: Line 3 (the red line) shows terminal maximum power if the hub downlink fade condition is given and the remote's BUC gain compression point is known.

Without these two variables, the terminal is not allowed to increase power beyond the rated maximum; with these two pieces of information, the hub backoff control allows the power to adjust greater than budgeted margin.

#### L.2.2.2.5 Target Power

The target power for DPC is based on ModCod switch points (**Figure L-2**), which correspond to SNR requirement for  $BER = 5 \times 10^{-8}$ .

The calculated target power for a given  $E_s/N_0$  is increased by one switch point in this table; this is done to prevent unnecessary ACM switching if the terminal power is marginal, and also to give full range for set ModCod. This targeted power increase is independent of ACM operation.

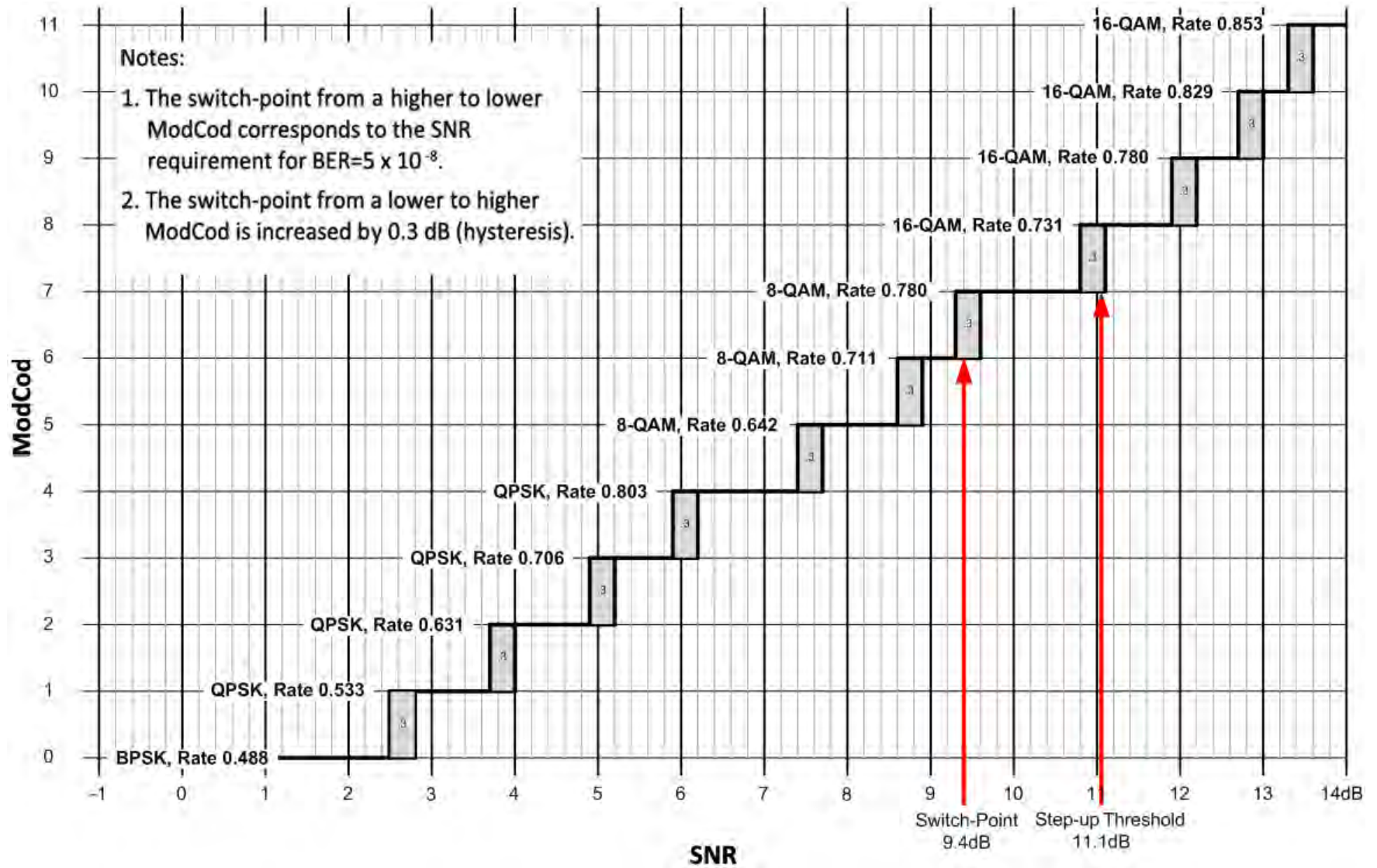

Figure L-2. ACM – ModCod Switch Points

### L.2.3 DPC Operational Considerations

Dynamic Power Control operates independently from any upper Network Management System (NMS), relying solely on a peer-to-peer exchange between the transmitting and receiving terminals. This means that the logic control is embedded into each unit and requires no interaction from any external process.

At a very basic level, the receiving demodulator is configured and assigned the Management IP Address of the corresponding remote modulator; the demodulator then starts sending an IP Packet (Link Quality Report Message, or LQRM) on varying timed intervals, depending on measured signal quality. The modulator receiving the LQRM compares the signal quality to target quality value, and adjusts its output power level accordingly.

DPC requires a power reference value in order to operate properly. While this value should be determined during clear-sky operation, the Adaptive Control Loop (ACL) will work either way.

The power reference value should equal the sum of the symbol rate, ModCod, and target  $E_s/N_0$ . This value becomes the mathematical pivot point from which all other power is calculated. For example, if the power reference measurement was taken during a 6 dB rain fade with terminal margin of 5 dB, the power control algorithm would re-adjust as the fade clears (leaving a -6 dB power delta) but the overall terminal margin is not affected, still providing fade increase of up to -1 dB. The only notable problem with calibrating during a fade is that the DPC delta reading is always at some offset from 0 dB, which represents clear-sky.

Power Reference also provides the point from which all dSCPC switch commands are calculated for new power adjustments. Without DPC, the VMS switching engine uses home state values to determine the power value to send to the modulator during a symbol rate/ModCod change. When using DPC, the power reference value is used to determine the modulator power, instead. In this case, VMS power is ignored and internal power calculation uses the following:

**Calculate Power:**

- Power Reference Base = Tx Power, ModCod, and Symbol Rate
- Target
- DPC Delta
- Switched Symbol Rate, and ModCod+Switch point
- Beam Offset (if roaming)

**Reference Error Check (not to exceed maximum power):**

- Equal or less than Tx Margin
- Equal or less than Rate Maximum Power
- Equal or less than Terminal Maximum Power (if known)

When you **enable** DPC, the ODM-840 waits for first or next LQRM before performing any power adjustment. Upon receipt, the ODM-840 internal Link Adaptation Manager acts in response to incoming messages, storing the data from the last LQRM. If this message contains an  $E_s/N_0$  value greater than or less than target, power is adjusted accordingly.

When you **disable** DPC, you modify the current modulator power, adding the margin at the current rate that remains as part of all other bandwidth changes. This means that the terminal is running at fixed power margin. The corresponding demodulator is notified of the state change, stopping the DPC's fast LQRM reporting on power greater than the target power. This prevents the CDD-880 from sending messages at the fast rate for power above target window. ACM, if enabled, operates normally.

---

### L.2.3.1 Adaptive Control Loop (ACL) Components

The ACL operates using separate components at both ends of the link. Each component plays a specific role in maintaining link quality during fade conditions:

- **CDD-880 Multi Receiver Router:** The CDD-880 incorporates a mechanism to maintain or adjust ACM during degraded conditions. This control uses the LQRM that is generated for each individual demodulator available within the unit, sending signal quality  $E_s/N_0$  value to its corresponding ODM-840. Messages are sent on timed intervals: 60 seconds normally, or 0.5 second if measured BER falls below defined thresholds or ModCod is below maximum ACM ModCod. The DPC function reuses this messaging to adjust power in conjunction with ACM control.
- **ODM-840 Remote Router:** The ODM-840 power control has two methods to automatically modify its transmit power:
  1. ECM "Power Hunt" adjusts power depending on burst success or failure, whereby power is modified from base reference or default setting (−40 dBm) in 3 dB steps, up to a maximum 9 dB of additional power.

ECM uses an open loop mechanism because burst CDD-880s cannot provide an accurate  $E_s/N_0$  per burst. This control is useful, during commissioning to find the initial power setting to switch to dSCPC, or during normal operation to compensate for conditions that may exceed the set power.
  2. In dSCPC, where the LQRM is used to adjust power during fade conditions and also to determine power reference during the calibration period.

### L.2.3.1.1 Closed Loop Mechanism

DPC is defined as a closed loop mechanism using an outer and inner feedback exchange between CDD-880 lock quality and ODM-840 Tx power.

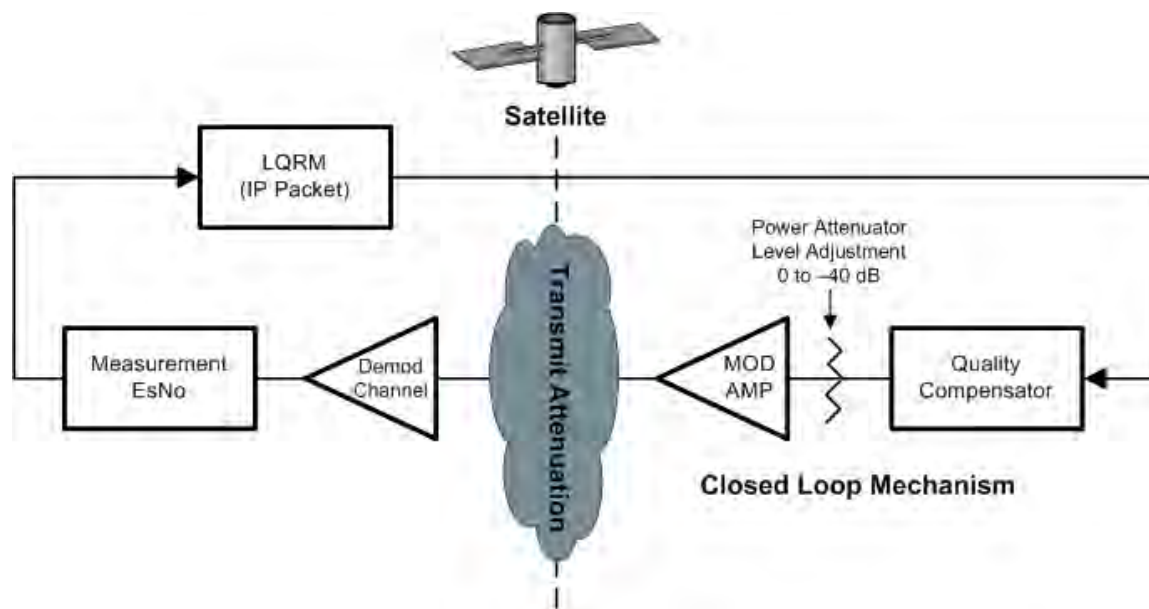

**Figure L-3. Closed Loop Mechanism**

As shown in the **Figure L-3** diagram, the **outer loop** requires that each CDD-880 send an LQRM (IP Packet) to a corresponding ODM-840 over the Management IP Network via the CTOG-250 Comtech Traffic Optimization Gateway w/CDM-800 Gateway Router WAN forwarding channel. The LQRM contains the demodulator's lock quality; unlocked/locked with current  $E_s/N_0$  value and sanity check<sup>1</sup> conditions; threshold; Max ModCod; DPC enable/disable state; and current symbol rate.

The **inner loop** is Tx power adjustment based on last reported LQRM with configured conditions.

The **control loop** is a constant handshake requiring certain conditions to be met before modifying power. The CDD-880 is assigned the Management IP Address of the corresponding ODM-840. Once assigned, the demodulator sends LQRM packets at either fast (500 ms) or slow (60 sec) rate; this rate depends on target window, ModCod, and lock condition.

The decision to send the LQRM fast or slow is contingent on internal checks of  $E_s/N_0$  value and current ModCod. These checks modify the timer to accelerate or slow down the send rate. The main check is: If  $E_s/N_0$  is outside of the target window ( $\pm .5$  dB), and/or the ModCod is not at maximum; then the fast timer is invoked. If ModCod is not at maximum, the timer will remain at fast rate.

<sup>1</sup> The sanity check allows the ODM-840 to compare against configured parameters, sending adjustments to the CDD-880 if mismatched. This exchange synchronizes modulator settings to demodulator checks.

When you disable DPC, the ODM-840 notifies the CDD-880 and modifies the timer check logic, changing the target window to  $E_s/N_0$  below .5 dB and/or ModCod is not at maximum. The reason for this change is, with DPC disabled, the power level is set to Current Power+Margin Moving Power>Target Power; if not changed, the timer would be at fast rate indefinitely. This change also allows ACM to operate normally without DPC.

### L.2.3.1.2 ACL Timers

Timers on both sides on the link are required to maintain quality and reduce hysteresis, with each end having a specific and separate function:

- **CDD-880 Messaging Timers** – CDD-880 timers are state-driven on when to send the next LQRM:
  - Every 500 ms, send  $E_s/N_0$  data
    - Unlocked,  $E_s/N_0$  outside target window or max ModCod mismatch.
  - Every 60 seconds, send  $E_s/N_0$  data, keep-alive
    - Locked,  $E_s/N_0$  = Target (target window  $\pm$ .5 dB)
- **ODM-840 Power Adjustment Timers** – ODM-840 timers are dependent on receipt or loss of LQRM:
  - Targeting Power adjustment (ratcheted steps)
    - .3 dB every 100 ms steps  $\geq$ 1 dB
    - .1 dB targeting steps <1 dB
  - Timeout on 60-second intervals
    - Two consecutive missed messages, 120 seconds
      - Drop to BPSK, go to rated max power
    - Four consecutive missed messages, 240 seconds
      - Recovery Mode, loss of LQRM, remove demod from active control list
      - Stay at BPSK until next LQRM



### L.2.3.2 LQRM Failure and Recovery Steps

Figure L-4 provides the flow chart of the LQRM and Power Management Send and Adjust Logic.

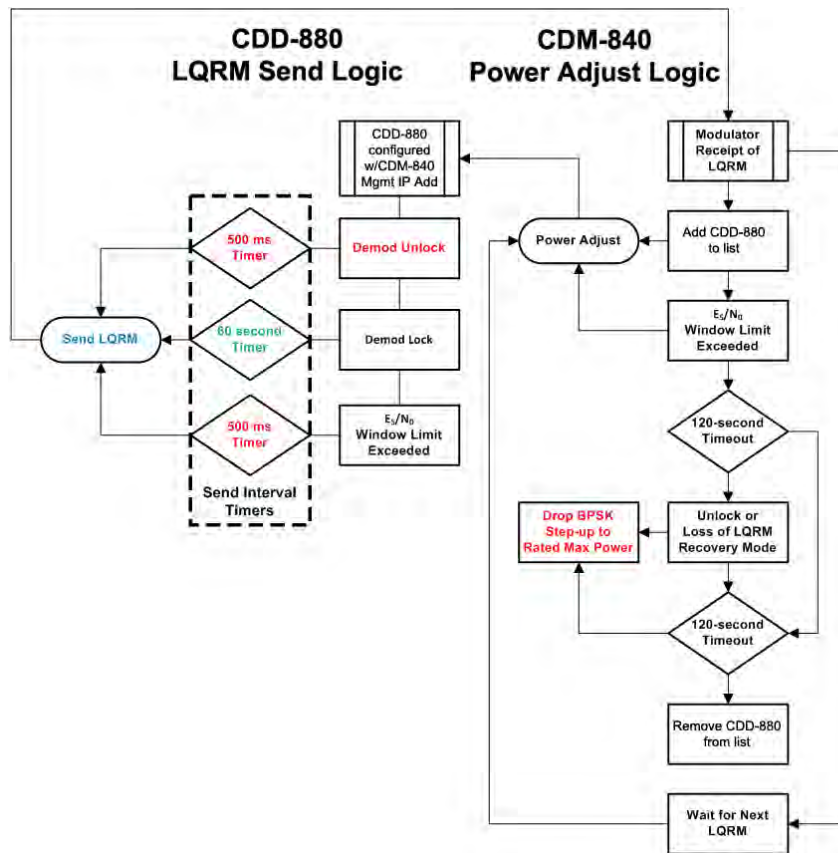

Figure L-4. LQRM / Power Management Flow Diagram

1. If the LQRM indicates a loss of lock, the new power value is immediately set to the rated or maximum power as an attempt to regain communication.
2. Once the power value changes, a timer prevents further power value or ModCod changes for a duration of 800 ms; this helps prevent the ODM-840 from modifying the power value on the basis of stale data.
3. If a ODM-840 hasn't received an LQRM from the CDD-880 in 120 seconds (two consecutive slow rate missed messages), it drops into recovery mode, adjusting the power value to rated or maximum adjusting ModCod to BPSK.
4. Once in recovery mode, a timer is set for an additional 120 seconds. If that timer expires with no message from the CDD-880, the ODM-840 removes that CDD-880 from its internal control list and waits for the next LQRM. At that point, the ODM-840 is done with that particular unit and may either continue ACM and DPC to any other CDD-880 that is reporting in, or just maintain the Tx at BPSK and at the increased power level until it again hears from any CDD-880.

### L.2.3.3 DPC with ACM

DPC and ACM function independent of one another, whereby power is modified first or second in combination with ACM. Depending on conditions, DPC and ACM can be operated exclusively or in combination, sharing the same resources for checks and balances. When DPC and ACM are operating in combination, the ODM-840 receives the LQRM comparing value to current settings and depending on conditions adjusts power or modifies ModCod.

Figure L-5 depicts Dynamic Power Control operating with ACM.

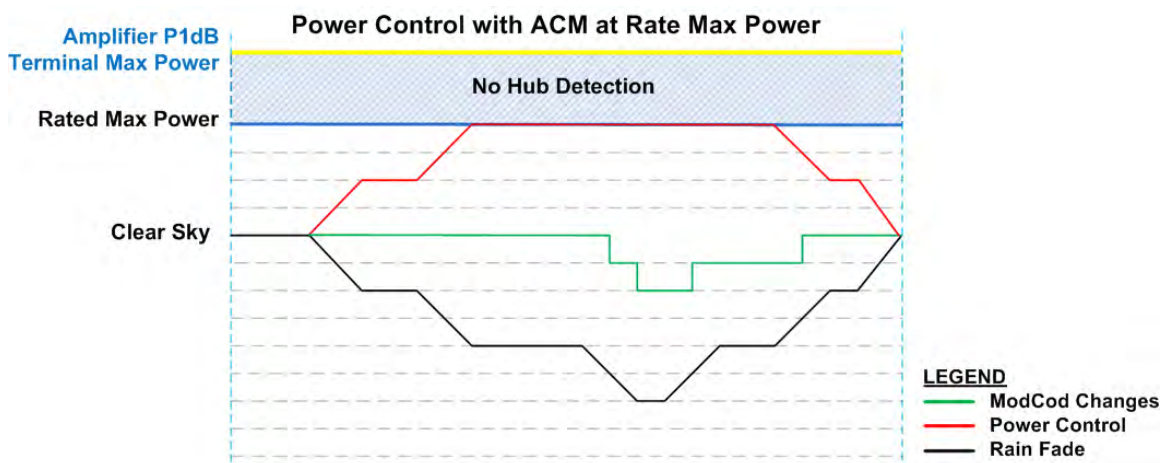

Figure L-5. DPC with ACM at Rate Max Power

- As Carrier-to-Noise Ratio (C/N) is decreased, output power is increased until rated maximum power margin is achieved, clamping power change.
- As C/N continues to decrease, the ACM function commences to reduce ModCod.
- Further, as C/N increases, ModCod is adjusted, first leaving power at maximum until quality indicates reduction in power. Such reduction represents the terminal power control operating without hub backoff information, preventing power from increasing beyond margin.

### L.2.3.4 Terminal Maximum Power

Terminal Maximum Power is achievable only if the remote terminal has information on the hub end environmental conditions, and the remote end's gain compression point (P1dB) is determined. If the hub can relay downlink information for clear-sky or degraded signal quality, the remote terminals are allowed to increase their power beyond the Rate Maximum Power setting.

Terminal Maximum Power Control operates using a hub-generated outbound Universal Announcement (UA) message, which is broadcast to all listening remotes on timed intervals. The UA message that is generated and sent by the CTOG-250 contains an attenuation value and other network routing information. This attenuation value is a number is from 0 to 799, with the CDM-800 indicating invalid/"no attenuation" information. Each remote operating in DPC mode cannot increase power greater than Rate Maximum Power unless the hub's attenuation message represents a value less than or equal to the Terminal Maximum Power setting.

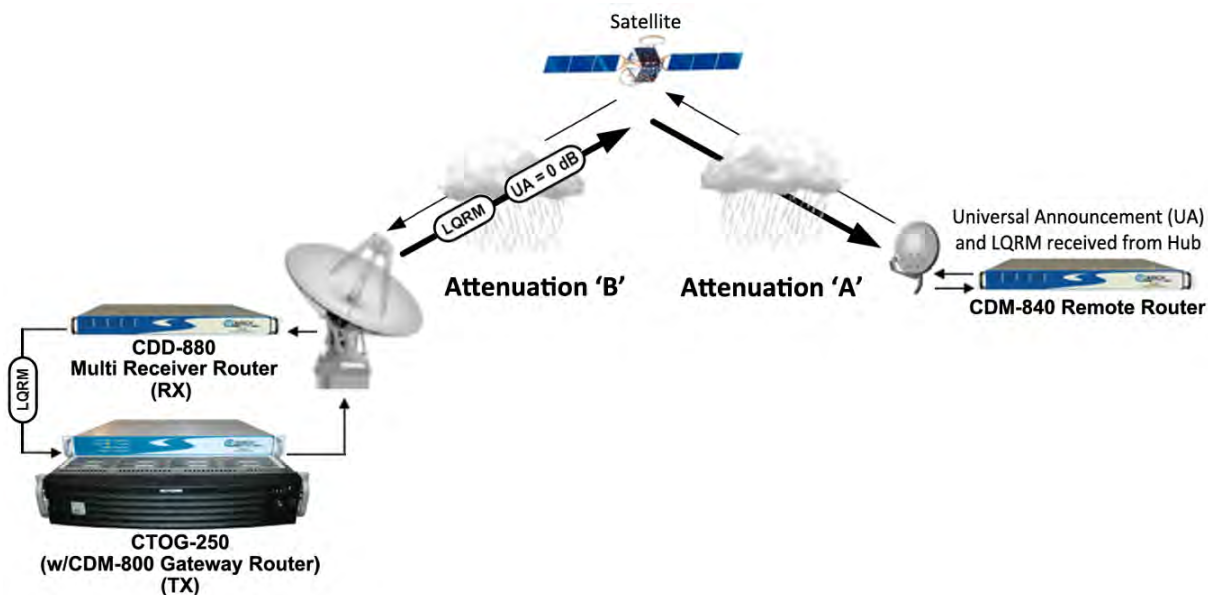

**Figure L-6. Hub Rain Fade**

For example, see **Error! Reference source not found.** If the remote Rate Maximum Power is  $-15$  dBm with a Terminal Maximum Power setting of  $-5$  dBm and the hub attenuation is  $0$  dB, then the remote may increase its power up to  $+10$  dB without violating its PEB or link budget Service Level Agreement (SLA). This is possible because, if the hub is indicating clear-sky (UA= $0$  dB), the only contribution of reported low  $E_s/N_0$  is Attenuation 'A' (between the remote transmit uplink and the satellite).

If the UA were to indicate a value other than  $0$  dB, then for Attenuation 'B' at the downlink, the terminal would add this value to the GCP backoff, reducing the terminal maximum power. *Note that terminal maximum power is with ModCod backoff applied.*

### L.2.3.5 DPC with ACM and Hub Backoff

If hub fade is known, the transmit power is allowed to increase beyond rated maximum power and up to backoff power, possibly preventing degraded performance by not modifying ModCod under ACM control.

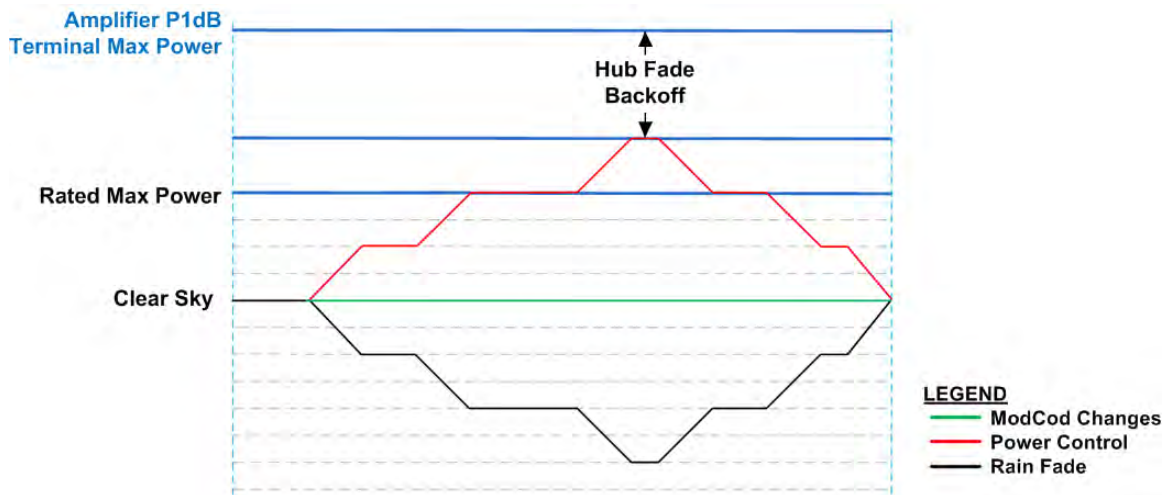

Figure L-7. DPC w/ACM with Hub Backoff

The **Figure L-7** graph depicts DPC with hub backoff:

- As C/N decreases, output power increases until terminal maximum power or backoff limit is achieved, clamping power change.
- Depending on the amount of fade, the ModCod may not change.

---

### L.2.3.6 Hub Fade Control

The hub attenuation information fully optimizes power control, allowing the remote terminal to use all of available amplifier power to sustain data throughput without jeopardizing SLA. However, it can be difficult to determine if the hub downlink is in a fade condition. The problem involves measuring link quality variations from clear-sky to degraded performance, if the hub cannot receive its own uplink carrier or if the servicing satellite does not provide a beacon signal.

Hub downlinks with satellite beacon signals provide the most reliable and accurate reference for realizing if the carriers from the satellite to the hub are being attenuated. A beacon receiver can measure the satellite signal and provide C/N; by reading this level, the system can set a reference of clear-sky. With a reference point established, any reduction of that signal is distributed to all receiving remotes in the service area network.

To accomplish this control, the CTOG-250 sets up SNMP polling to the beacon receiver that is measuring the satellite's downlink carrier for C/N. The periodic polled value is first stored in the CTOG-250's reference snapshot of clear-sky condition, which sets the minimum attenuation in the UA messaging. From that "zero point" reference, any variation is updated and broadcast to all receiving remotes, providing an additional backoff value from terminal maximum.

An alternate method is a collaborative approach, whereby outbound ACM remote LQRMs are collected at the corresponding CTOG-250 and stored in a table that is periodically updated. The link quality values formulate a variation in power using a statistical averaging algorithm, which the system uses to determine hub downlink fade.

## L.2.4 Roaming with DPC

The Roaming Oceanic Satellite Server (ROSS) is an integrated location server that works in conjunction with Comtech EF Data's Vipersat Management System (VMS) to facilitate on-the-move satellite communications for oceanic vessels. With the support of ROSS, the modem power margin is modified depending on the Effective Isotropic Radiated Power (EIRP) value. ROSS stores multiple contours per service area, with each beam contour assigned a number (0 to 255) in order of power, high to lower gain.

Roaming DPC provides additional control within a service area with multiple beam contours. As the vessel roams between beam contours, the power difference from beam-to-beam is applied to the ODM-840 DPC beam offset control, adjusting the terminal's power margin by adding or subtracting the beam power differences. The net effect on power is that the maximum power scale is increased or decreased, depending on the vessel's location within that satellite service area.

The beam offset plays a very important role in maintaining power during beam contour transitioning. If the power control is operated without this additional adjustment, the uplink power may exceed budget, or the vessel could drop communication all together because of insufficient margins.



For more information about ROSS, please see adjunct Comtech EF Data publication MN/13070 ROSS Roaming Oceanic Satellite Server Installation and Users Guide.

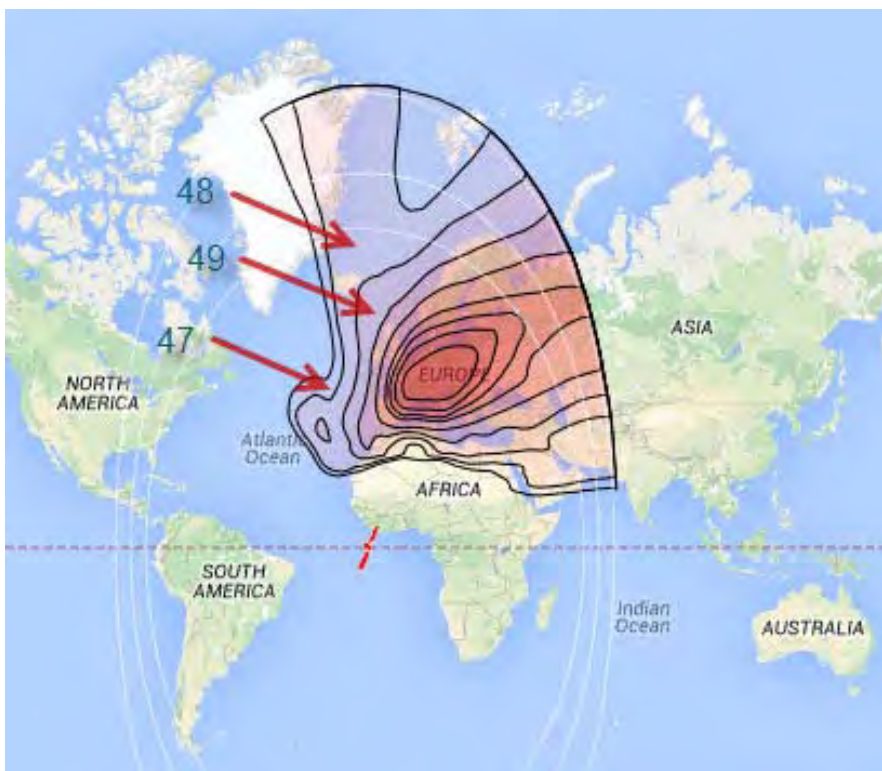

Figure L-8. Roaming DPC

---

## L.3 DPC Operation

Dynamic Power Control and ACM work independent of one another. This gives you the option to run DPC with or without ACM. This section assumes all other operational parameters have been previously configured.



For detailed information, see:

- **Chapter 6. ETHERNET-BASED REMOTE PRODUCT MANAGEMENT and Chapter 7. SERIAL-BASED REMOTE PRODUCT MANAGEMENT in this manual.**
- **Chapter 6. ETHERNET-BASED REMOTE PRODUCT MANAGEMENT and Chapter 7. SERIAL-BASED REMOTE PRODUCT MANAGEMENT in the CDD-880 Multi Receiver Router Installation and Operation Manual (CEFD P/N MN-CDD880).**
- **VMS v3.x.x VIPERSAT Management System User Guide (CEFD P/N MN/22156)**

The CDD-880 and ODM-840 provide several means for configuring Dynamic Power Control operation via Remote Product Control with a user-supplied PC:

- CDD-880 and ODM-840 HTTP (Web Server) Interfaces using a compatible Web browser.
- Ethernet-based Simple Network Management Protocol (SNMP) using a Network Management System (NMS) and Management Information Base (MIB) File Browser.
- Serial-based Remote Control Interface using a terminal emulation program or Windows Command-line.



**COMTECH EF DATA STRONGLY ENCOURAGES USE OF THE CDD-880 AND ODM-840 HTTP INTERFACES FOR MONITOR AND CONTROL (M&C) OF THE CDD-880 AND THE ODM-840. COMTECH EF DATA RECOMMENDS USE OF THE SERIAL-BASED REMOTE CONTROL INTERFACE AND THE ETHERNET-BASED SNMP INTERFACE ONLY FOR ADVANCED USERS.**

**THE HTTP INTERFACE FIGURES AS FEATURED THROUGHOUT THIS APPENDIX ARE INTENDED FOR USER REFERENCE ONLY AND ARE SUBJECT TO CHANGE. THE FIRMWARE INFORMATION (I.E., REVISION LETTERS, VERSION NUMBERS, ETC.) AS DISPLAYED MAY DIFFER FROM YOUR SETUP.**

### L.3.1 DPC Operation Using the HTTP Interfaces

Figure L-9 shows the ODM-840 and CDD-880 HTTP Interface “splash” pages, and the menu tree diagrams for accessing the operation specified in this appendix for DPC operation. Page functionality not specific to DPC operation appears dimmed in these diagrams.

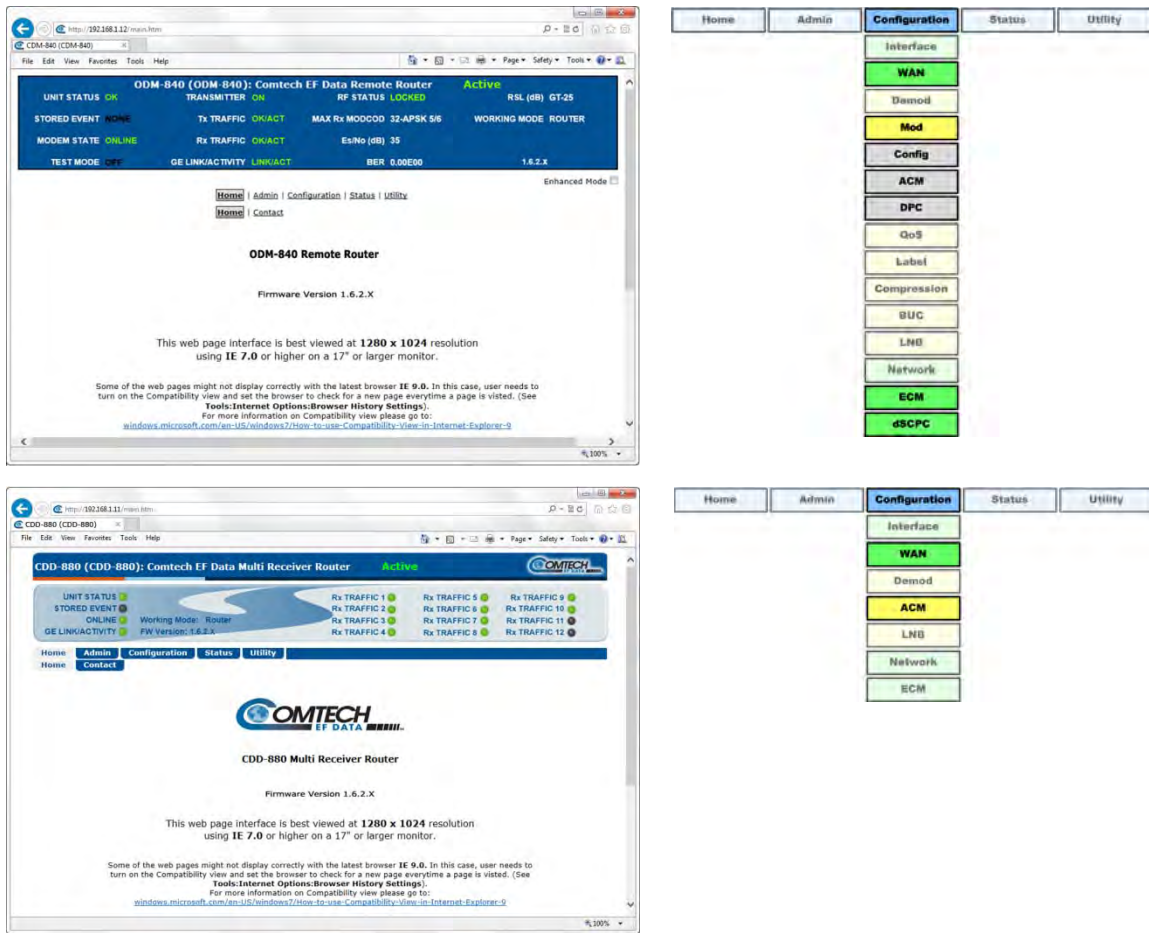

(TOP) ODM-840 HTTP Interface  
(BOTTOM) CDD-880 HTTP Interface

Figure L-9. HTTP Interfaces – Splash Pages and DPC Operation Menu Trees (FW Ver. 1.6.2.X)



### L.3.1.1 Configure DPC

Do these steps:

1. In the **ACM Demodulator Settings** section of the CDD-880 HTTP Interface 'Configuration | WAN | ACM' page, set the corresponding ODM-840 Management IP Address. If the system is running dSCPC, this address is set automatically. Once you set this address and click **[Submit]**, the CDD-880 begins to send LQRMs.

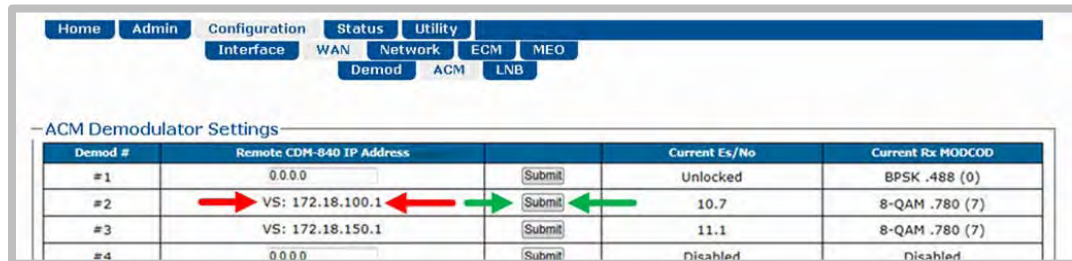

2. In the **Tx Dynamic Power Control (DPC) Configuration** section of the ODM-840 HTTP Interface 'Configuration | WAN | Mod | DPC' page, use your network's link budget information to enter the terminal's **Maximum Data Rate** and the **Tx Power Margin**. Click **[Submit]** when done.

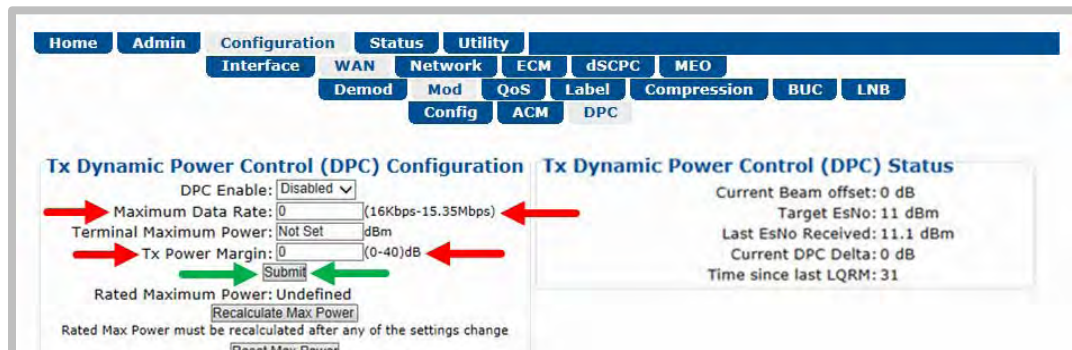

3. **If operating with ACM:** Use the drop-down list in the **Tx ACM Configuration** section of the ODM-840 HTTP Interface 'Configuration | WAN | Mod | ACM' page to select the desired **Max MODCOD**. Click **[Submit]** when done.

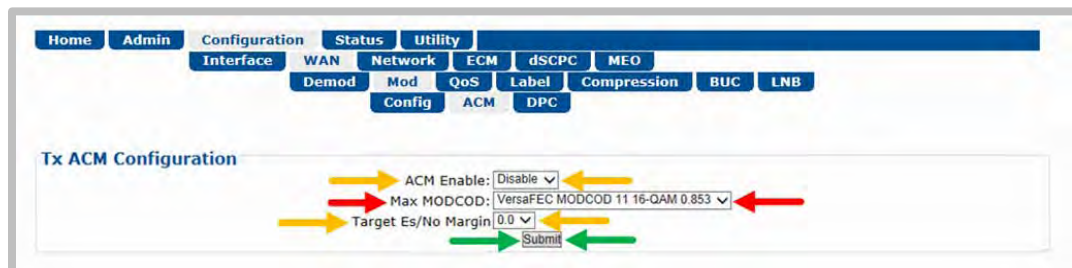



- It is not important to enable ACM at this time.
- Leave the Target Es/No Margin at 0.0.
- Dynamic Power Control provides additional power margin for all of the MODCOD switch points. Adding any ACM margin will deduct from the DPC power margin, which is a one-for-one subtraction.
- When operating in dSCPC, the Max MODCOD is set automatically from the Site Default MODCOD setting. The Max MODCOD drop-down list is therefore dimmed, allowing no selection.

4. Use the drop-down list in the **Tx Dynamic Power Control Configuration** section of the ODM-840 HTTP Interface 'Configuration | WAN | Mod | DPC' page to enable DPC. Click **[Submit]** when done.



- ACM is not required for DPC operation.
- Terminal Maximum Power is left at “Not Set” at this time and will not be applied until hub fade detection is available.

### L.3.1.2 Power Reference in DPC Operation

Once DPC is configured, the power reference setting is vital to the overall operation of DPC. The reference setting is an automatic feature that requires a dSCPC transmission link between a ODM-840 and its corresponding CDD-880 at the hub; outbound communication is assumed. The link can be statically or dynamically established, and at any data rate at or below budget maximum.

When calibrating the reference, the system uses the ACL to adjust power until it reaches the optimal target value. This is accomplished through an exchange of messaging between units at a fast rate – taking the set values, adjusting power, and comparing against limits before allowing the reference set to complete.

#### L.3.1.2.1 Set Power Reference

To set the reference, the remote must be operating with an established link in dSCPC. The link data rate can be anywhere between remote site minimum or maximum, and MODCOD is at (default) maximum.

1. If the link is established **statically**, use the ODM-840 HTTP Interface to do these steps:
  - a) Use the **'Configuration | WAN | Mod | Config'** page to establish the communications link, set the Modulator Frequency, and select the MODCOD, Symbol Rate and Data Rate.

The screenshot shows the 'Modulator' configuration page. At the top, there are navigation tabs: Home, Admin, Configuration, Status, and Utility. Under 'Configuration', there are sub-tabs: Interface, WAN, Network, ECM, dSCPC, and MEO. Further down, there are more sub-tabs: Demod, Mod, QoS, Label, Compression, BUC, and LNB. The 'Mod' tab is selected, and the 'Config' sub-tab is active. The main content area is titled 'Modulator' and contains the following fields:

- Data Rate: 200 (16.000-15358.508) Kbps
- Symbol Rate: 141.734 (16.000-4500.000) Ksps
- FEC Type: VersaFEC
- Tx Frequency: 1205 (950.0000-2150.0000)MHz
- MODCOD: VersaFEC MODCOD 3 QPSK 0.706
- \*(Note: in CCM mode, changing the MODCOD setting will change the Symbol Rate automatically)\*
- Tx Scrambler: Normal
- Roll Off: 35%
- Spectrum Invert: Normal
- Power Level: -15 (-40.0 - 0.0) dBm
- Carrier State: Off

The screenshot shows the 'Modulator Frequency' configuration page. It contains the following fields:

- Tx RF Frequency: 0 (0-67150.0000) MHz
- BUC LO Mix: Low (-)
- BUC LO Frequency: 0 (0 | 3000-65000) MHz
- Tx L-Band Frequency: 1205 (L-Band: 950.0000-2150.0000) MHz

A note states: "Note: BUC will not be uploaded. BUC control can be found [here](#)."

- b) Manually adjust the modulator power until the return path demod locks with good data (pings).
- c) Use the drop-down list in the **Tx Dynamic Power Control Configuration** section of the **'Configuration | WAN | Mod | DPC'** page to enable DPC. Click **[Submit]**, then allow power to target (ACM operation is not required).

The screenshot shows the 'Tx Dynamic Power Control (DPC) Configuration' page. At the top, there are navigation tabs: Home, Admin, Configuration, Status, and Utility. Under 'Configuration', there are sub-tabs: Interface, WAN, Network, ECM, dSCPC, and MEO. Further down, there are more sub-tabs: Demod, Mod, QoS, Label, Compression, BUC, and LNB. The 'Mod' tab is selected, and the 'DPC' sub-tab is active. The main content area is titled 'Tx Dynamic Power Control (DPC) Configuration' and contains the following fields:

- DPC Enable: Disabled
- Maximum Data Rate: 0 (16Kbps-15.35Mbps)
- Terminal Maximum Power: Not Set dBm
- Tx Power Margin: 0 (0-40)dB
- Rated Maximum Power: Undefined
- Buttons: Recalculate Max Power, Reset Max Power
- Turn All DPC Settings Off
- Reset All Parameters to Factory Default

To the right, there is a 'Tx Dynamic Power Control (DPC) Status' section with the following information:

- Current Beam offset: 0 dB
- Target EsNo: 14.3 dBm
- Last EsNo Received: Not locked
- Current DPC Delta: 0 dB
- Time since last LQRM: 4592

At the bottom, there is a 'Power Reference' section with the following information:

- Reference Tx Power: 0 dBm
- Reference MODCOD: undefined
- Reference Symbol Rate: 0 ksps
- Buttons: Set Reference
- Note: Setting references will force a reload of the page when successful

**Tx Dynamic Power Control (DPC) Configuration**

DPC Enable:  (16Kbps-15.35Mbps)

Maximum Data Rate:  (16Kbps-15.35Mbps)

Terminal Maximum Power:  dBm

Tx Power Margin:  (0-40)dB

Rated Maximum Power:  dBm

Rated Max Power must be recalculated after any of the settings change

- d) In the **Power Reference** section of the '**Configuration | WAN | Mod | DPC**' page, click **[Set Reference]**:

**Power Reference**

Reference Tx Power: 0 dBm

Reference MODCOD: undefined

Reference Symbol Rate: 0 ksps

Note: Setting references will force a reload of the page when successful

- e) If **[Set Reference]** fails, note the failure, correct the condition, and click **[Set Reference]** once more.
2. If the link is established **dynamically**, use the ODM-840 HTTP Interface to do these steps:
- a) Use the '**Configure | ECM**' page to enable ECM with correct TAP parameters:

**ECM Remote Configuration**

Mode:

Note: In order to take control from VMS, please disable ECM

Multicast IP:

Group ID:

Power Hunt Enable:

Rx LO Frequency:  MHz

Tx LO Frequency:  MHz

ECM Power:

**ECM Remote Status**

Cycle Length: 0 msec

Aloha State: Idle

Current Tap: 0

Home State Revert Timer: 0 seconds

Time in ECM: 0 seconds

Seconds Until Next Probe: 0 seconds

**ECM Tx Statistics**

Total Count: 0

Successes: 0

Failures: 0

No Detect: 0

Last Status: No Detect

Seconds since last xmit: 0 days 2 hours 19 minutes 7 seconds

- b) Either manually set **ECM Power** or enable **Power Hunt** to adjust power until the return path ECM demod locks with good data (VMS registration completes).

- c) Use the **'Configuration | dSCPC'** page to switch to dSCPC manually (using the **Load Switching Configuration** section) or automatically (using the **ToS Switching Configuration** section).

The screenshot shows the 'Configuration | dSCPC' page. It has a navigation bar with 'Home', 'Admin', 'Configuration', 'Status', and 'Utility'. Below that are sub-tabs: 'Interface', 'WAN', 'Network', 'ECM', 'dSCPC', and 'MEO'. The 'dSCPC' tab is active.

**Load Switching Configuration**

Mode:

Step Up Threshold (%): (0-100)

Step Down Threshold (%): (0-100)

Step Up Delay (Sec): (10-60)

Step Down Delay (Sec): (10-600)

Excess Capacity (%): (0-100)

**ToS Switching Configuration**

Enable:

Max # of Sessions (per TOS Id):

Index	Name	ID	Type	SCPC Data Rate	Timeout		
0	<input type="text"/>	<input type="text" value="0"/>	<input type="text" value="0"/>	<input type="text" value="0"/>	<input type="text" value="0"/>	<input type="button" value="Change"/>	<input type="button" value="Delete"/>
1	<input type="text"/>	<input type="text"/>	<input type="text"/>	<input type="text"/>	<input type="text"/>	<input type="button" value="Add Entry"/>	

- d) Use the drop-down list in the *Tx Dynamic Power Control (DPC) Configuration* section of the **'Configuration | WAN | Mod | DPC'** page to enable DPC. Click [Submit], and allow power to target (ACM operation is not required).

The screenshot shows the 'Tx Dynamic Power Control (DPC) Configuration' page. Red arrows point to the 'DPC Enable' dropdown menu (set to 'Disabled') and the 'Submit' button. Green arrows point to the 'Rated Maximum Power' field (set to 'Undefined') and the 'Set Reference' button. Below the 'Set Reference' button is a note: 'Rated Max Power must be recalculated after any of the settings change'. There are also buttons for 'Recalculate Max Power' and 'Reset Max Power'.

- e) In the **Power Reference** section of the **'Configuration | WAN | Mod | DPC'** page, click [Set Reference].

The screenshot shows the 'Power Reference' section. It displays: Reference Tx Power: 0 dBm, Reference MODCOD: undefined, Reference Symbol Rate: 0 ksp/s. A green arrow points to the 'Set Reference' button. Below this is a note: 'Note: Setting references will force a reload of the page when successful'. At the bottom is a 'Reset Power' button.

- f) If [Set Reference] fails, note the failure, correct the condition, and click [Set Reference] once more.

### L.3.1.3 DPC – Status Reporting

Once reference calibration is complete, the **Tx Dynamic Power Control (DPC) Status** section of the **Configuration | WAN | Mod | DPC** page provides information on the ongoing DPC state. Each received LQRM updates this status section; any changes to power are noted between **Target Es/No** and **Current DPC Delta**.

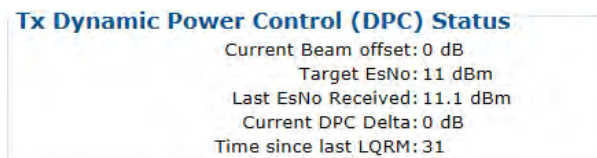

After the targeting of reference calibration, the DPC Delta is zeroed, and any +/- offset from this point indicates power changes due to link quality variations.



**Depending on symbol rate, small rates will have variations up to ±.5 dB, even during clear-sky conditions.**

Item	Description
<b>Current Beam offset</b>	<b>Current Beam offset</b> is modified in a roam configuration, and any +/- offset from zero either adds or subtracts from the margin or terminal maximum power backoff during a beam contour variation.
<b>Target Es/No</b>	<b>Target Es/No</b> is calculated from maximum MODCOD and will remain constant unless changed.
<b>Last Es/No Received</b>	This most recent reported value may change depending on link conditions.
<b>Current DPC Delta</b>	This represents the Adaptive Control Loop (ACL) change in power compared to the set reference, which can increase to margin or terminal maximum power. Any decrease has the full remaining range down to -40 dBm of modulator's output.
<b>Time since last LQRM</b>	This is the time, in seconds, from the last power report received. Under normal conditions, the status updates every 60 seconds.

### L.3.1.4 DPC – Operational Changes

DPC operation modifies the behavior between VMS site policy home state parameters and power reference control.

Normally, the operator updates the home state parameter in the VMS to match the current settings in the ODM-840. This synchronizes the power settings between the two, providing correct power adjustments when the VMS sends a switch command to modify transmission rates.

When you enable DPC, you now modify power with the ODM-840 and ignore any power setting in the switch command; this changes the behavior of the home state settings. The home state settings remain very important for frequency domain check, but you now use the power only to limit the site's symbol rate. During each rate change, the VMS calculates a new power value, comparing this value against the Up-converter's power limit value; if the calculated power is less

than or equal to this value, the requested rate is set. However, if the calculated power is greater than this value, the requested rate will be limited to the set limit.

---

## L.4 Firmware Update



**The order of firmware update is important – Comtech EF Data recommends that you first update the CDD-880, and then update the ODM-840.**

Firmware update notes apply to systems running Firmware Versions 1.5.2.1 or lower that require the DPC feature.

The DPC feature is designed not to affect any current operational settings during an update of firmware. The parameter setting for power will remain the same until reference calibration in the ODM-840 is applied, meaning that system will operate normally.

---

## L.5 Final Considerations

DPC is not an accurate system or absolute solution. As fading varies with time, it is not possible to keep up with changes as they occur quickly. This is particularly the case when scintillation is occurring. Scintillation – when due to either low elevation troposphere effects or to the ionosphere in tropical regions – sometimes involves changes of several dB per second. When DPC is operated in combination with ACM, the system may reduce throughput during such quick changes, but regains as the loop control catches up to resume normal operation.









---

2114 WEST 7TH STREET TEMPE ARIZONA 85281 USA  
480 • 333 • 2200 PHONE  
480 • 333 • 2161 FAX